

Light Commercial & Commercial, Residential

VRF

VRF systems provide air conditioning solutions that meet the requirements of a diverse range of buildings.

VRF systems provide air conditioning solutions for large residences as well as large commercial buildings.

V-002 VRF Series Overview
V-004 VRF Outdoor Units Lineup
V-006 Features

VRF Outdoor Units



VRF J Series Heat Pump for Small-capacity type

V-020 VRF J-VS
V-026 VRF J-IVS
V-030 VRF J-IV
V-034 VRF J-IVL



VRF V Series Heat Recovery Modular type

V-040 VRF VR-IV

Heat Pump Modular type

V-050 VRF V-IV

VRF INDOOR UNITS

V-058 VRF Indoor Unit Lineup for J-VS
V-066 VRF Indoor Unit Lineup for J-IVS, J-IV, J-IVL, VR-IV, V-IV

VRF

Light Commercial
& Commercial,
Residential



FUJITSU GENERAL (Euro) GmbH
participates in the ECP program for VRF.
Check ongoing validity of certificate:
www.eurovent-certification.com

FUJITSU GENERAL LIMITED

VRF Series Overview

Recommended VRF products for various buildings



VRF J-VS



Maximum 6 HP Heat Pump

This product uses R32, a new environmentally friendly refrigerant. With TOP-class energy efficiency and compact design, it can be installed in a limited and narrow space without being conspicuous. Indoor unit connectable up to 130%.

- Sustainable(R32)
- Saving CO2
- Small Body
- Situational Piping Design
- Sightliness installation



Page V-020

VRF VR-IV



Maximum 48 HP Heat Recovery

Smart, cutting-edge design
Extensive lineup from 8 HP to 48 HP with the capacity ratio of indoor units connectable up to 150%.

- Simultaneous cooling and heating operation using a single refrigerant system
- Annual cooling operation
- Accommodating changes in temperature difference



Page V-040

VRF J-IVS



Maximum 6 HP Heat Pump

The 998 mm compact design does not obstruct the view even when installed underneath a waist-high window, ideal for large houses and retail stores. Indoor unit connectable up to 130%.

- Spaces saving and low sound level design
- Flexible system configuration for homes, stores, and small buildings



Page V-026

VRF V-IV



Maximum 48 HP Heat Pump

Smart, cutting-edge design
Available in a wide range of models from 8 to 48 HP in 2 HP increments with the capacity ratio of indoor units connectable up to 150%.

- Excellent energy saving
- High design flexibility for placement in any building
- Easy installation and maintenance



Page V-050

VRF J-IV



Maximum 6 HP Heat Pump

J-IV is connectable with up to 14 indoor units (Indoor unit connectable up to 150%) making it suitable for commercial facilities housing a number of small stores.

- High energy efficiency
- Flexible system configuration for small and midsize buildings



Page V-030

VRF J-IVL



Maximum 18 HP Heat Pump

J-IVL is an outdoor unit with a slim design. Its flexibility in installation makes it ideal for midsize office buildings and hotels. With the newly added 14/16/18 HP models, up to 42 indoor units* are connectable, making them ideal for hotels and educational facilities with many rooms.

- Slim Outdoor Unit
- Small room application
- Class-leading Low Operating Sound



Page V-034

Design Simulator



























































































When installing air conditioning equipment in each room of a building, it is necessary to select an indoor unit suitable for the heat load in the room and derive an outdoor unit that can cover the capacity of all indoor units. In addition, remote controls and converters are selected according to how the customer will manage the air conditioner, and in some cases, a design combined with options may be required to comply with established standards. The "Design Simulator" can be used to facilitate the selection of such complex equipment and the output of system drawings and estimates. (Software for PC)



For more information



VRF Outdoor Units Lineup

Capacity (kW)		12.1	14.0	15.1-15.5	22.4	28.0	33.5	40.0	45.0	50.0-50.4	55.9	61.5	67.0	73.5	78.5	85.0	90.0	95.0	100.5	107.0	112.0	118.5	123.5	130.0	135.0	
HP		4	5	6	8	10	12	14	16	18	20	22	24	26	28	30	32	34	36	38	40	42	44	46	48	
J-VS Series																										
		AJY040 KCTAH	AJY045 KCTAH	AJY054 KCTAH																						
J-IVS Series																										
		AJY040 LCLDH	AJY045 LCLDH	AJY054 LCLDH																						
J-IV Series																										
		AJY040 LBLDH, AJY040 LELDH	AJY045 LBLDH, AJY045 LELDH	AJY054 LBLDH, AJY054 LELDH																						
J-IVL Series																										
					AJY072 LELDH	AJY090 LELDH	AJY108 LELDH	AJY126 LELDH	AJY144 LELDH	AJY162 LELDH																
VR-IV Series Heat Recovery	Space Saving																									
	Set Model				AJY072 GALDH	AJY090 GALDH	AJY108 GALDH	AJY126 GALDH	AJY144 GALDH	AJY162 GALDH	AJY180 GALDH	AJY198 GALDH	AJY216 GALDH	AJY234 GALDH	AJY252 GALDH	AJY270 GALDH	AJY288 GALDH	AJY306 GALDH	AJY324 GALDH	AJY342 GALDH	AJY360 GALDH	AJY378 GALDH	AJY396 GALDH	AJY414 GALDH	AJY432 GALDH	
	Energy Efficiency																									
	Set Model							AJY144 GALDHH				AJY198 GALDHH		AJY216 GALDHH	AJY234 GALDHH	AJY252 GALDHH	AJY270 GALDHH	AJY288 GALDHH	AJY306 GALDHH	AJY324 GALDHH	AJY342 GALDHH	AJY360 GALDHH	AJY378 GALDHH	AJY396 GALDHH		
V-IV Series Heat Pump	Space Saving																									
	Set Model				AJY072 LALDH	AJY090 LALDH	AJY108 LALDH	AJY126 LALDH	AJY144 LALDH	AJY162 LALDH	AJY180 LALDH	AJY198 LALDH	AJY216 LALDH	AJY234 LALDH	AJY252 LALDH	AJY270 LALDH	AJY288 LALDH	AJY306 LALDH	AJY324 LALDH	AJY342 LALDH	AJY360 LALDH	AJY378 LALDH	AJY396 LALDH	AJY414 LALDH	AJY432 LALDH	
	Energy Efficiency																									
	Set Model							AJY144 LALDHH			AJY180 LALDHH		AJY216 LALDHH	AJY234 LALDHH	AJY252 LALDHH	AJY270 LALDHH	AJY288 LALDHH	AJY306 LALDHH	AJY324 LALDHH	AJY342 LALDHH	AJY360 LALDHH	AJY378 LALDHH	AJY396 LALDHH			

Features

High-efficiency

High-efficiency is achieved significantly by the use of a DC twin-rotary compressor, inverter technology, and a large heat exchanger.

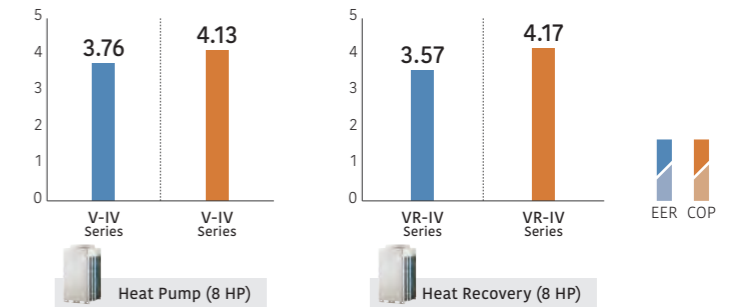
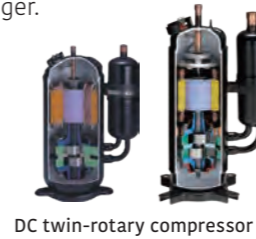

* These specifications are determined by ducted combination.

ALL DC High-efficiency design with top-class SEER/SCOP

All the VRF Series, including the J-IVL Series, have DC technology to achieve high-efficiency operation. This enhances the durability and reliability of the VRF Series.

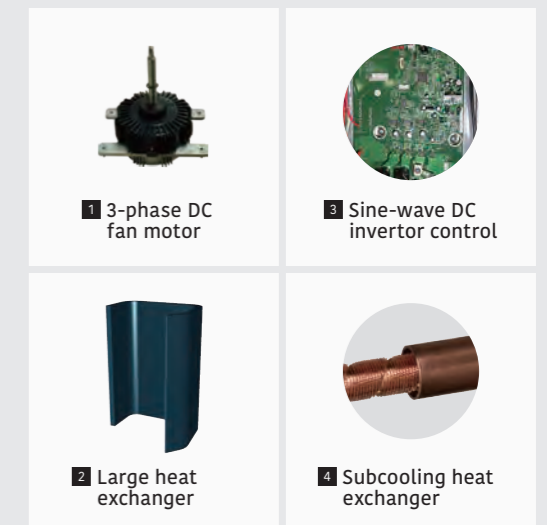
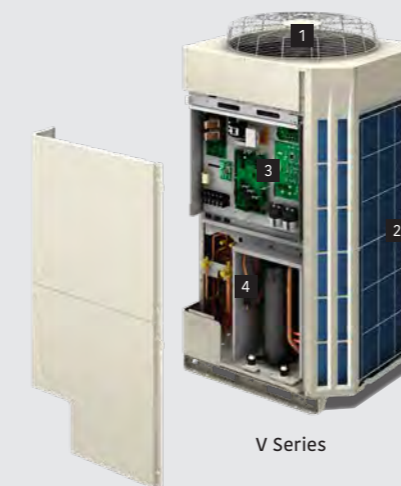
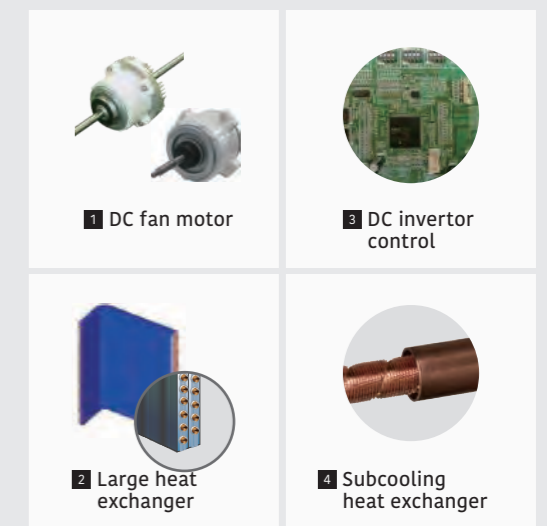

Efficient control of operation

Setting temperature range limitation

Sets the minimum and maximum limits on room temperature to establish an optimum balance between energy-saving performance and a comfortable environment.

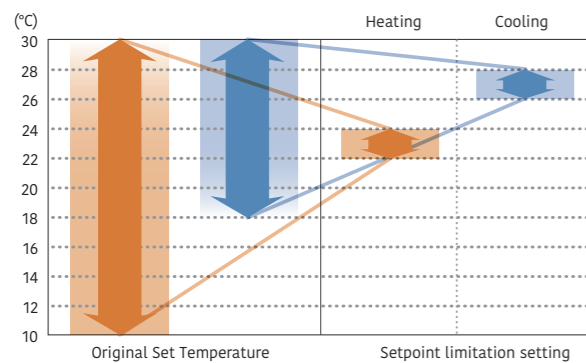

Auto-off timer

The wired remote controller is equipped with an auto-off timer function that automatically stops operation after a fixed period of time has elapsed from the start of operation to avoid wasting energy. The function also allows you to set the interval for stopping operations.

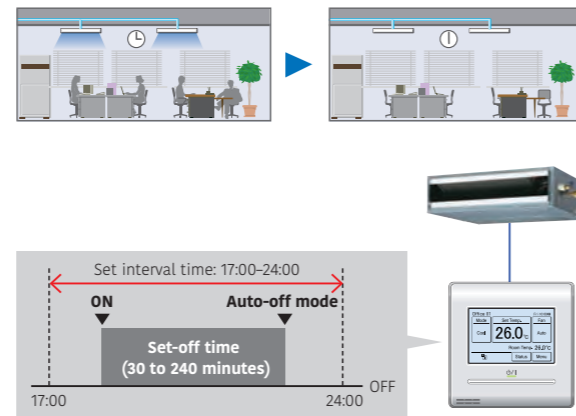

Energy-saving management

A variety of energy-saving operations can be set and managed depending on the season, climate, and time period. Excellent energy-saving operation using the system controller.

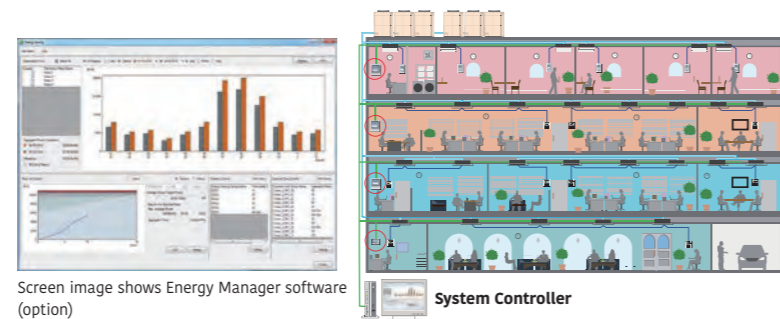

Capacity-saving mode

Operation capacity can be reduced in 5 steps from the rated capacity. This mode cuts down on peak power consumption and eases the maximum load on the unit.

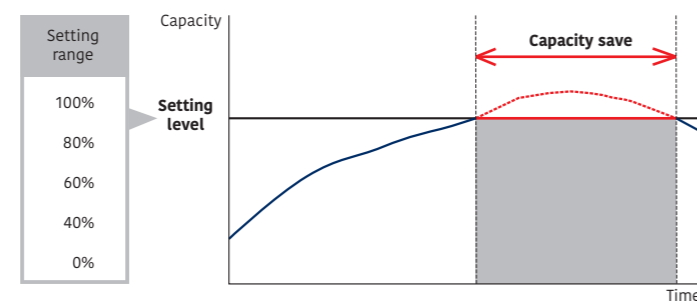

Intelligent refrigerant control

Fujitsu General is proposing outdoor units equipped with refrigerant control function. The refrigerant control operates with subtle control corresponding to the heat load of the room and offers a more comfortable environment. The refrigerant control can also provide increased energy savings.

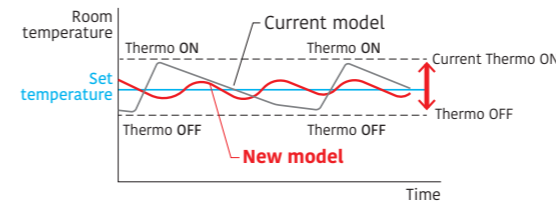

Current refrigerant control

Thermostat-ON/OFF occurs frequently.
→ Frequent changes in room temperature interfere with comfort. The compressor starts and stops repeatedly, wasting energy.

New refrigerant control

The thermostat is turned on and off less frequently than under current control to maintain the room temperature at the target temperature. Compared to current control, the compressor will run longer, thus saving energy.

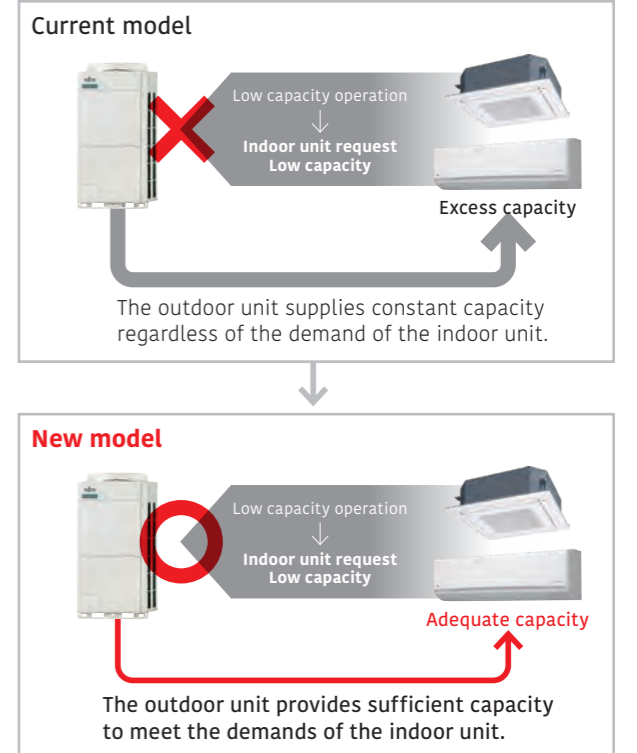

* The improvements due to the control and the actual sine wave vary depending on the combination of the indoor unit and system operating conditions.

More Comfort



Auto changeover

In Auto setting, the air conditioner switches between cooling and heating modes automatically according to the set temperature and the room temperature.

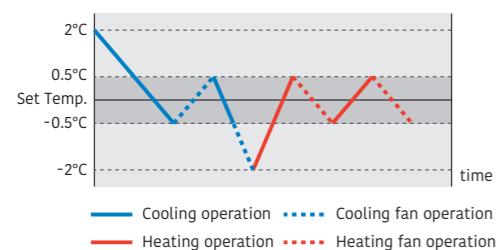

Auto changeover settings enable the indoor unit to easily switch between cooling and heating regardless of the operating mode of other indoor units. These settings can be made using a wired remote controller for a specific indoor unit. Provides a comfortable environment all year round.

Automatic cooling/heating operation for each room is possible

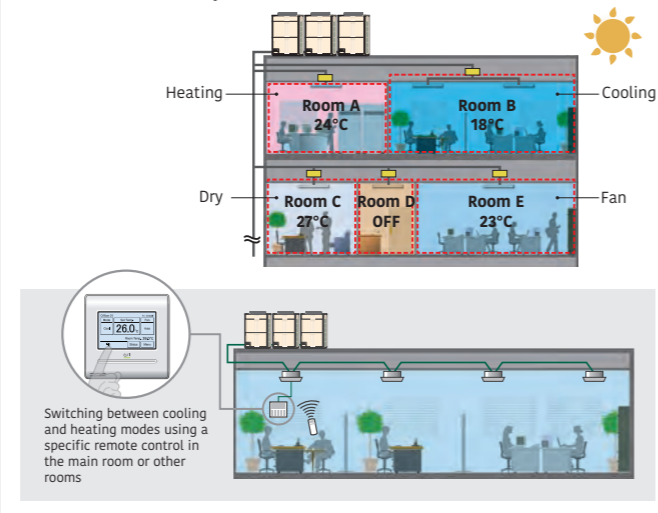

Precise control of refrigerant flow

The combination of DC inverter control and individual control of electronic expansion valves of an indoor unit enables precise and smooth control of the refrigerant flow. This means the room temperature can be set in increments of 0.5°C.

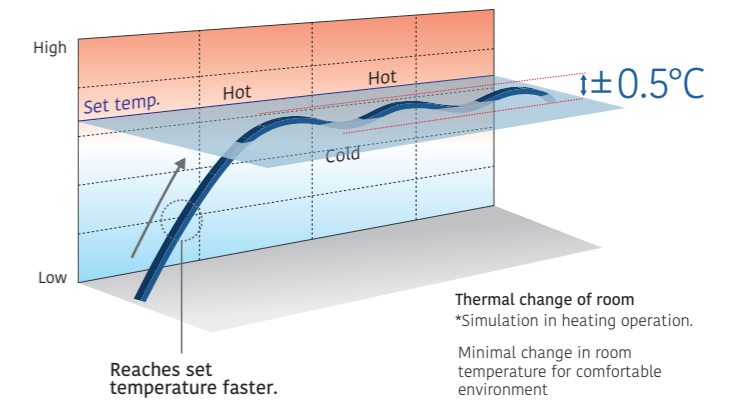

Quiet operation

Quiet operation

Two low noise modes can be switched over automatically between one in which low noise is prioritized over performance, and the other in which performance is prioritized over low noise, depending on the room temperature and outdoor temperature. This feature can be controlled by external input from the outdoor unit or a system controller.

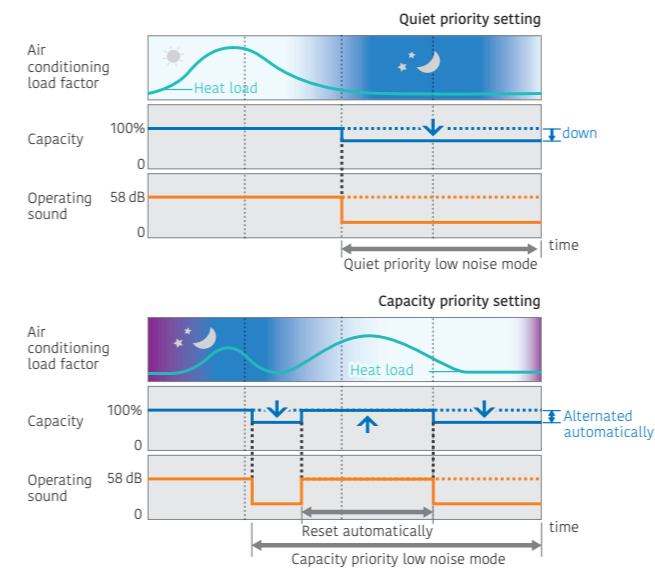

Non-stop oil recovery operation

A comfortable room condition is maintained during oil recovery mode because the product continues to operate without stopping the cooling or heating operation.

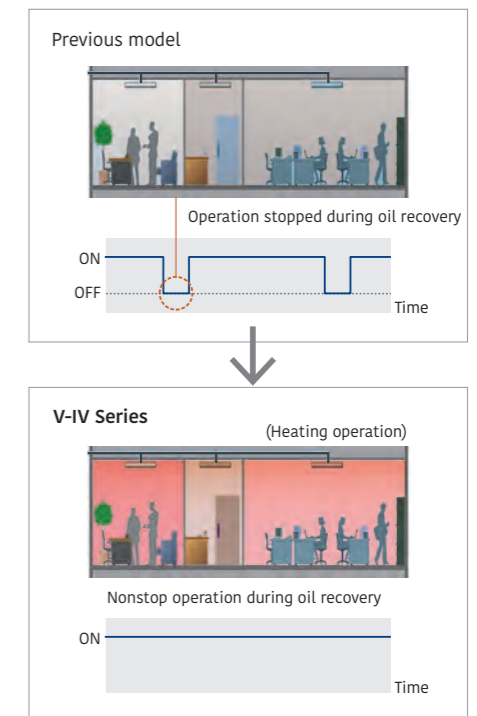

Switching room temperature sensing position for improved heating comfort (Option)

The optional remote sensor kit (UTY-XSZXZ1) can be connected to the indoor unit to improve comfort by installing the unit at a height appropriate for the living environment.

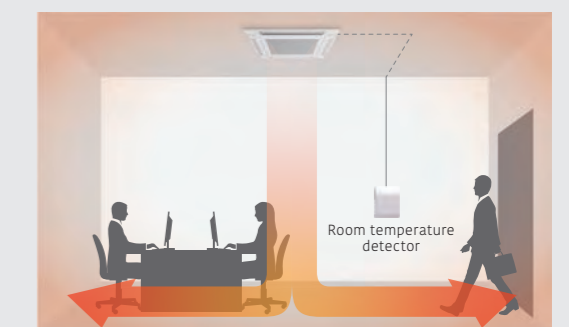

High Reliability

Outdoor unit rotation

The compressor starting order is rotated to equalize the cumulative running time of each unit.

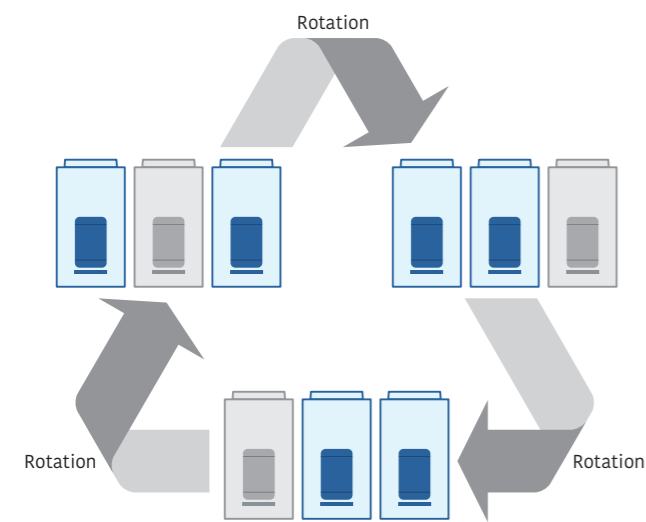

The start and stop timings are alternated among connected compressors.

Backup operation

If one compressor fails, the other compressors will initiate backup operation*.

Note: Backup operation may not be possible depending on the cause of failure.

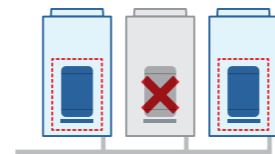

Advanced refrigerant control

Compressor control logic controls the inverter speed to balance the mass airflow rate of refrigerant in each outdoor unit.

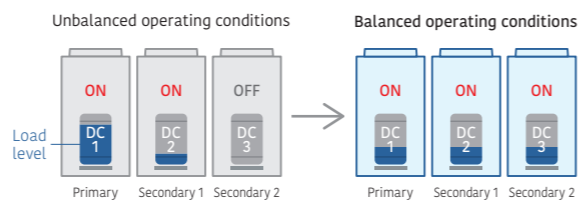

Protection against liquid flowback

The use of a large accumulator means that refrigerant that has not been completely vaporized stays inside the accumulator to ensure no liquid refrigerant is fed into the compressor.

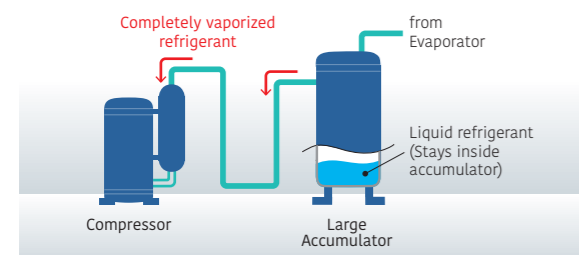

Blue fin heat exchanger

The anti-corrosion blue fin treatment is applied to the heat exchanger of the outdoor unit.

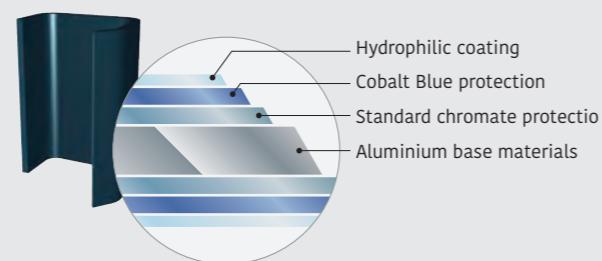

Design Flexibility

Class-leading compact design

An industry-leading compact outdoor unit with optimal airflow pattern design. (Up to 18 HP)



Long pipe design

Pipe design suitable for long and narrow office buildings with elevation differences and low-rise stores with long distances (VRF J-IVL Series)

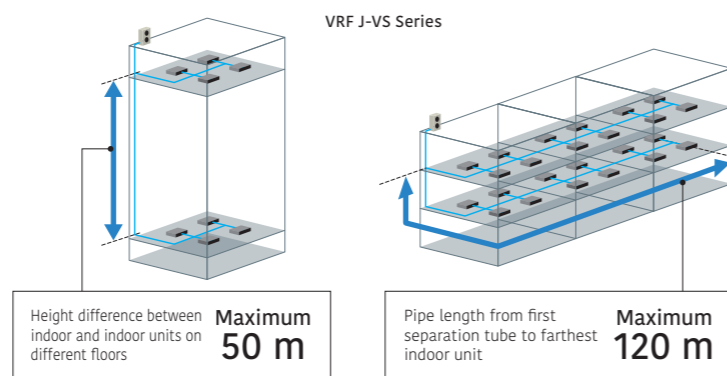

Max. allowable overall pipe length: 1,000 m

The class-leading pipe length of 1,000 m increases flexibility of installation in a wide variety of buildings.

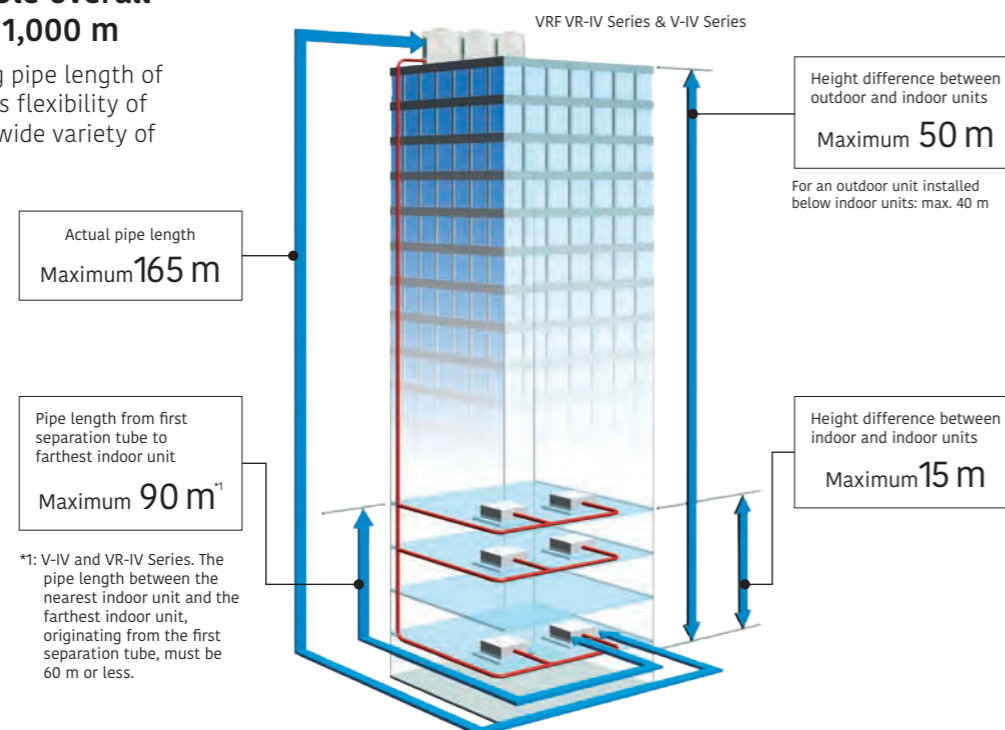

*1: V-IV and VR-IV Series. The pipe length between the nearest indoor unit and the farthest indoor unit, originating from the first separation tube, must be 60 m or less.

High-capacity connection

Series	Connectable indoor unit capacity range	Connectable indoor units
VRF J-VS Series Heat pump type	50% to 130%	up to 13 ^{*5}
VRF J-IVS Series Heat pump type	50% to 130%	up to 13 ^{*5}
VRF J-IV Series Heat pump type	50% to 150%	up to 14 ^{*5}
VRF J-IVL Series 14/16/18 HP Heat pump type	50% to 150%	up to 42 ^{*3}
VRF J-IVL Series 8/10/12 HP Heat pump type	50% to 150%	up to 30 ^{*4}
VRF VR-IV Series Heat Recovery Modular type	25% ^{*5} to 150%	up to 64
VRF V-IV Series Heat Pump Modular type	50% to 150% ^{*2}	up to 64

*2: The maximum capacity of the combination that includes the 18-HP outdoor unit is below 150%.
 *3: J-IVL Series 18-HP model only.
 *4: J-IVL Series 12-HP model only.
 *5: 6-HP model only.

Designed for low refrigerant charge

The optimal design of the indoor and outdoor units reduces the amount of refrigerant required and can be easily installed in a room as small as 15 m².



Various optional parts

- Fresh air intake kit to bring in fresh air
- Comfortable temperature control with a remote sensor
- DX kit links ventilation equipment and air handling units.



Low ambient operation

Our refrigeration cycle technology enables cooling operation even at -15°C.



Wide operating temperature range

All outdoor units have a wide operating temperature range and can operate in extreme temperature conditions.

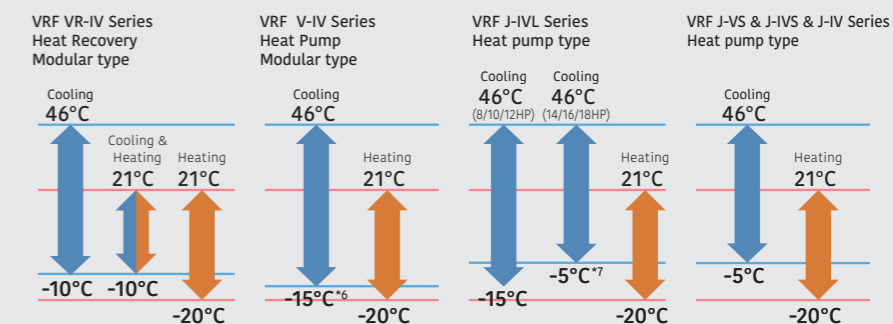

*6: When multiple outdoor units are connected, their operating temperature range is from -5°C to 46°C in cooling.

*7: The operating range is -15°C to 46°C only for systems with all indoor units rated at 5.6 kW or more.

Easy Installation



Easily transported

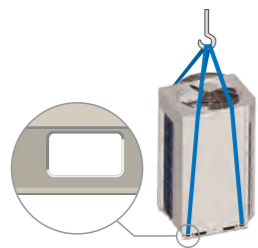

A lifting strap can be hooked onto an outdoor unit. Design of outdoor unit allows for lifting straps to be used.

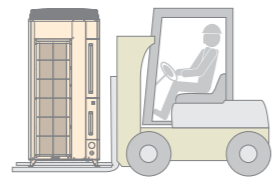

Transportable by forklift. The outdoor unit can be lifted and transported by forklift.

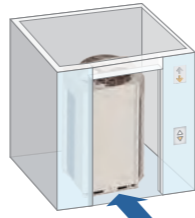

Fits into a small elevator.

Easy access

The removable L-shaped front panel provides more room for installation and service work. Multiple installations can be performed easily and efficiently even in tight spaces.

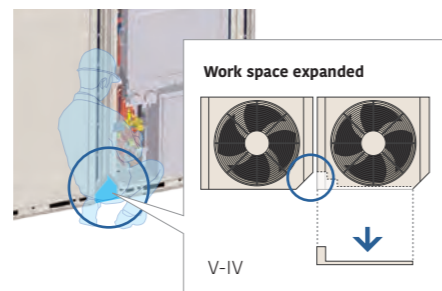

Front access reduces installation intervals.

Flexible pipe connection

Piping and wiring can be accessed from the front, left, right, and bottom.



Simplified wiring work

The communication wiring can be installed seamlessly among indoor, outdoor, and RB units, which makes the installation of the wiring system easier.

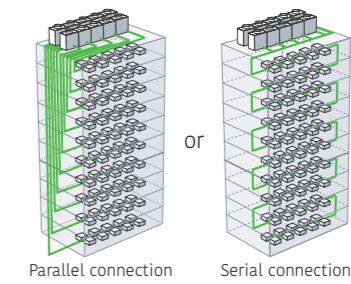

Maximum wiring length: **3,600 m**

Note: The automatic address setting is not available on a serially connected multiple refrigerant system.

Vacuum mode function for easy evacuation

The vacuum mode function enables all expansion valves of an indoor unit to be opened fully, allowing for easier evacuation of air inside pipe lines and indoor units.

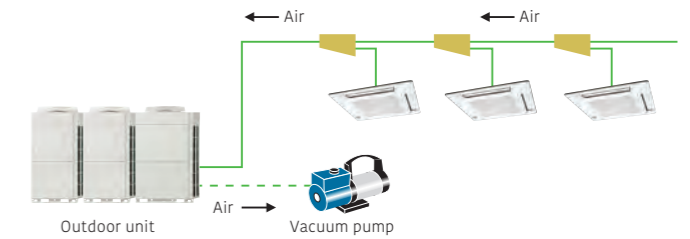

Automatic address setting

Addresses of connected indoor units, RB units, and Signal amplifier can all be set automatically from the PCB in the outdoor unit.

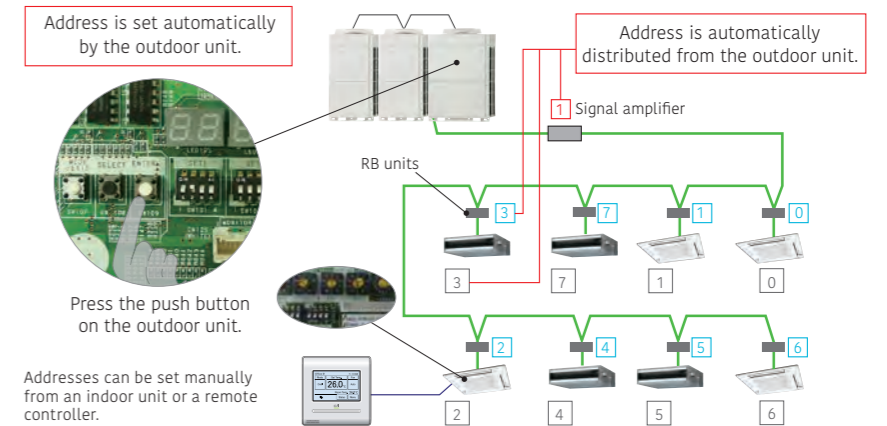

Easy commissioning with Tools

• Service Tool (UTY-ASGXZ1)

The Service Tool checks the refrigerant temperature and pressure, and the operating status of the electronic expansion valves, making it easy to determine if the units are connected properly.

• Central Remote Controller (UTY-DCGGZ3)

After the VRF system has been installed. Conveniently, the "test run" required to verify proper system operation can be performed from a nearby Central RC.

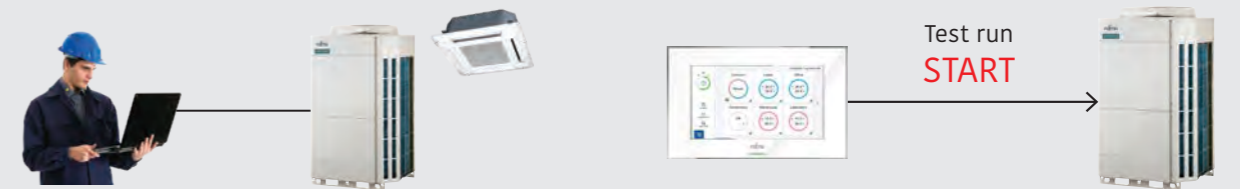

Easy Service and Maintenance

Designed for easy maintenance

A 7-segment indicator lamp panel provides detailed information on the function setting status, refrigerant temperature and pressure, compressor operation time, and other factors, facilitating self-diagnosis for each unit.

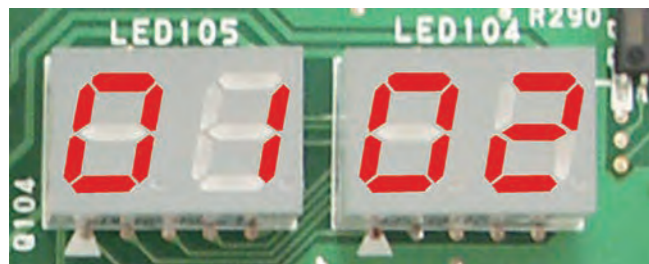

Easy-to-read 7-segment indicator lamp

Shows the following detailed operation and error status without need of any special tools.

Error status can be checked on an outdoor unit's display

- System operation mode
- Discharge temperature and pressure
- Compressor operation status
- Address, type, and number of outdoor unit

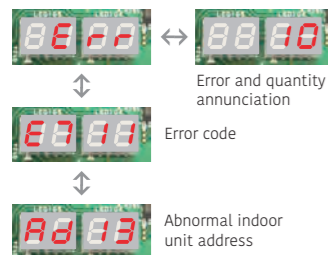

• Error status can easily be checked on an outdoor unit's display.

Movable PCB panel

Enables easier access behind the PCB for maintenance work.



The error status can be checked via a wired remote controller for indoor units.

Error codes are displayed on an LCD screen.

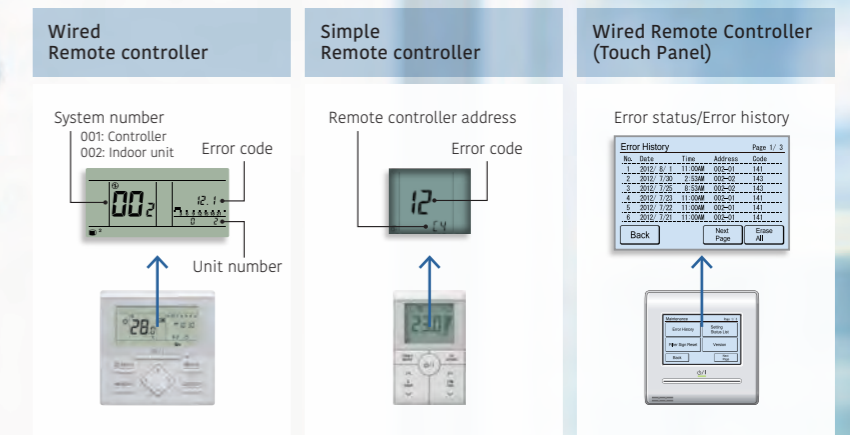

Error diagnosis by Service tool

Connection to Service tool

- A detailed operation status and recent error history can be checked and analyzed using Service tool.
- The last 5 minutes of operation status can be recorded continuously.

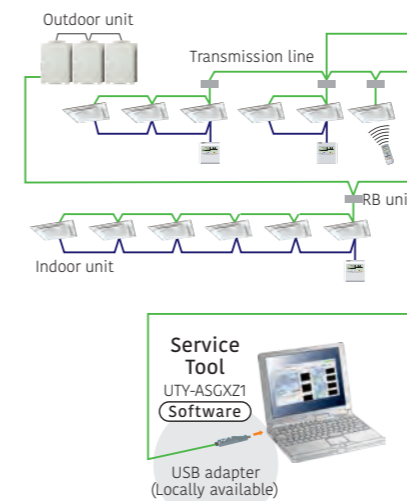

Remote monitoring

The Web Monitoring system enables the monitoring of the system's operation status at any time via the internet to ensure trouble-free operation. The operating VRF network system in the building can be monitored real time over the internet.

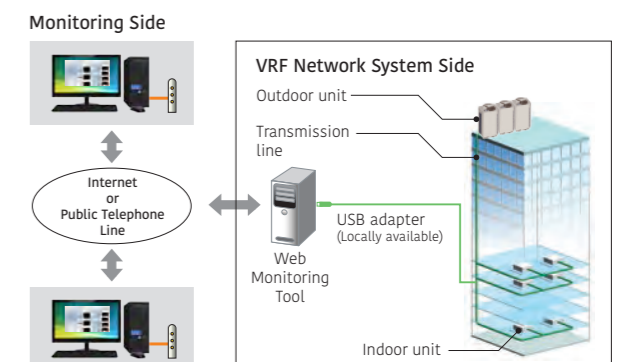



Heat Pump
for Small-capacity type

VRF **J-VS**

System configuration example

- Suitable for air conditioning small and medium-size buildings. One refrigerant system is used for each outdoor unit.
- Multiple indoor units are connected with separation tubes and headers.

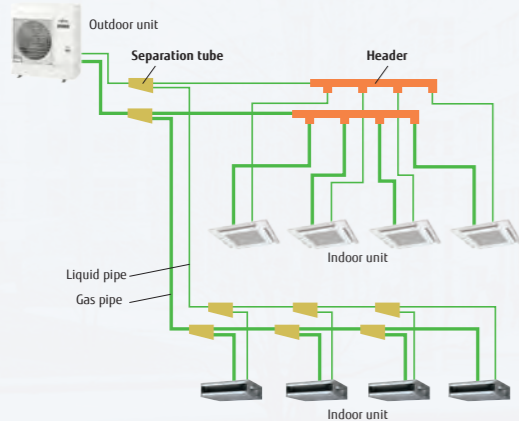

R32 refrigerant with reduced global warming potential

- **Zero** Ozone Depletion Potential (ODP^{*1})
- High environmental properties
- High performance
- Economically efficient

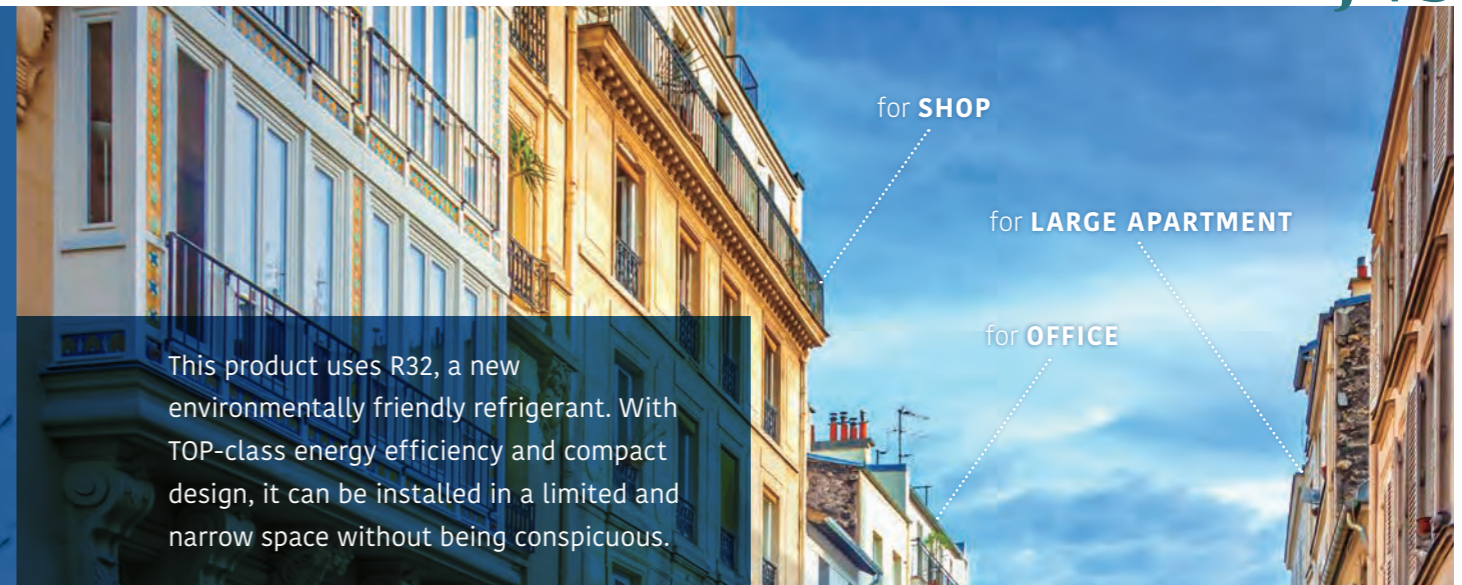
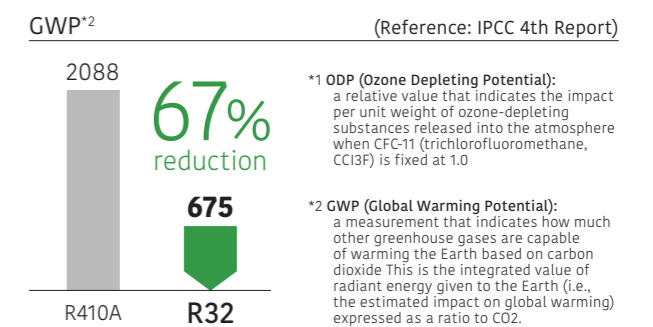

Sustainable

European F-Gas Regulation Plan

The European Union has tightened F-gas rules as part of European Green Deal policy, which aims for Europe climate neutral by 2050. The F-gas Regulation mainly includes

- (1) Reducing the total volume of HFCs and phasing out HFC in 2050.
- (2) The GWP limits for certain products are required to be strengthened.

Fujitsu General as one of its proactive efforts to preserve the global environment, we are working on technological development to achieve the best balance between refrigerants with lower GWP and energy efficiency of equipment adopting safety measures.

2029	2033	2035	2050
Available at J-VS			
Split AC & HP Over 12 kW: GWP 750 and above prohibited 12 kW or less: GWP 150 and above prohibited	Split AC & HP Over 12 kW: GWP 150 and above prohibited	Split AC & HP HFC use prohibited	an economy with net-zero greenhouse gas emissions.

Refrigerant saving design

Refrigerant saving design the compact indoor unit, piping design, and optimization of heat exchanger volume significantly reduce the system refrigerant volume.

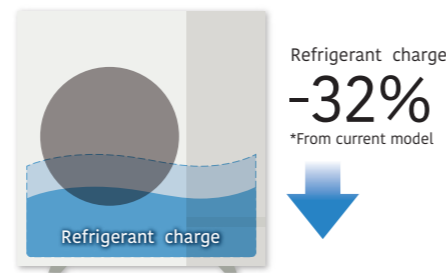

Enhanced disaster safety measures

The system is designed to meet the environmental safety requirements specified in the IEC 603352-40 standard for the use of R32 refrigerant. The environment requiring safety measures is determined by the size of the room in relation to the amount of refrigerant required. For example, if the system is designed for maximum pipe length and the refrigerant charge is 6 kg, safety measures are required for rooms of 15 m² or less.

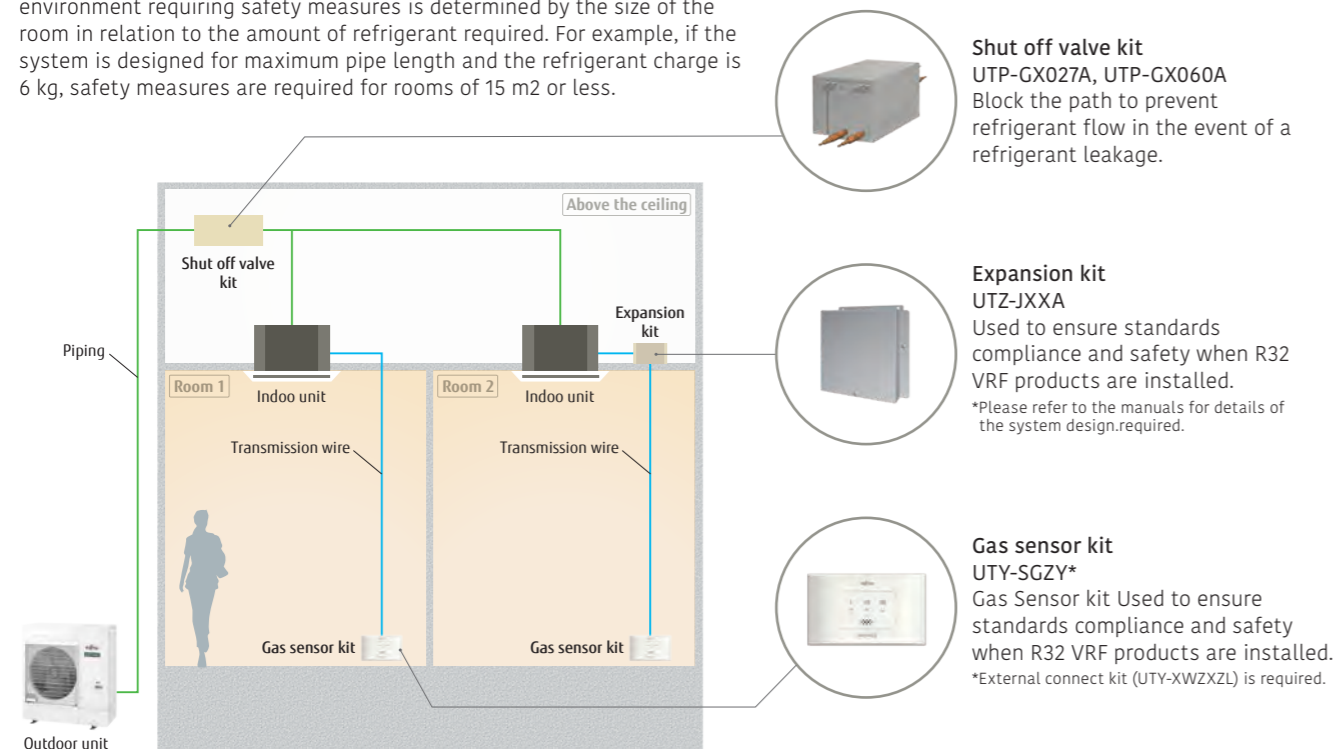

Saving CO2

TOP Class High Energy Saving

The use of large heat exchanger and a high-efficiency Rotary compressor achieves class-leading SEER/SCOP in all models.

SEER **8.27** *045 model
SCOP **5.37** *040 model

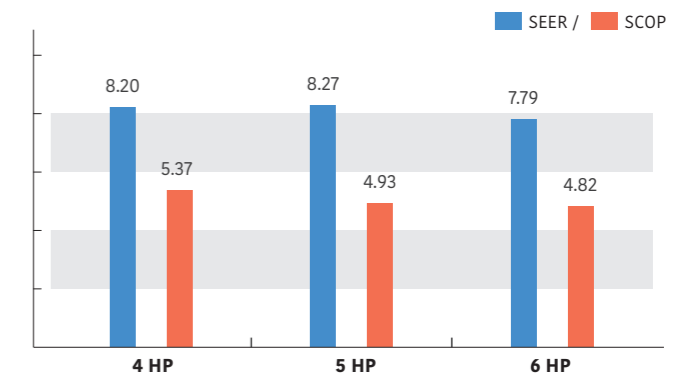

More Energy-Saving compressor control

When the room temperature approaches the set temperature after the start of operation, the capacity required for the outdoor unit becomes lower. The minimum compressor speed at this time can now be controlled at a lower value than with conventional products, enabling more energy-efficient operation.

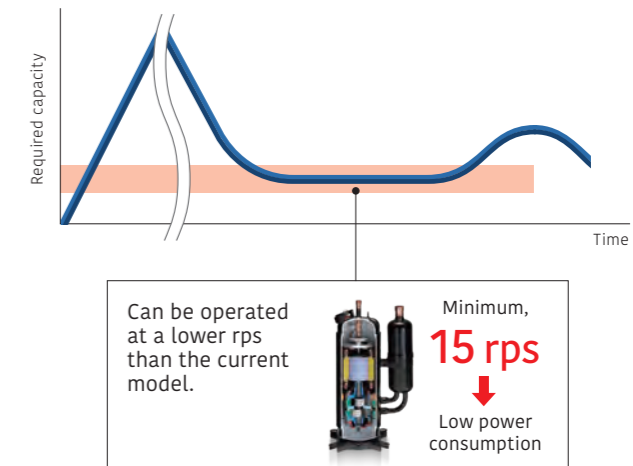

Small Body

Easy to carry, easy to install

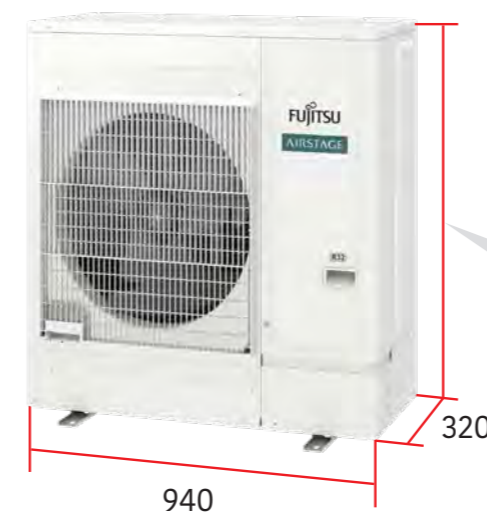

Small, lightweight outdoor unit

The outdoor units in this series are much more compact than conventional outdoor units of comparable capacity. They can be installed on a balcony, fitting below the height of the railing. With a height of less than 1 m, they can be installed in tight spaces such as under windows.



Situational Piping Design

Long pipe length

Our advanced refrigerant control technology extends the maximum allowable length of refrigerant piping to 120 m. This provides high flexibility in system design.

Long piping lengths are achieved by installing a large-capacity accumulator. No liquid refrigerant is supplied to the compressor even when the required amount of refrigerant is charged in the long piping.

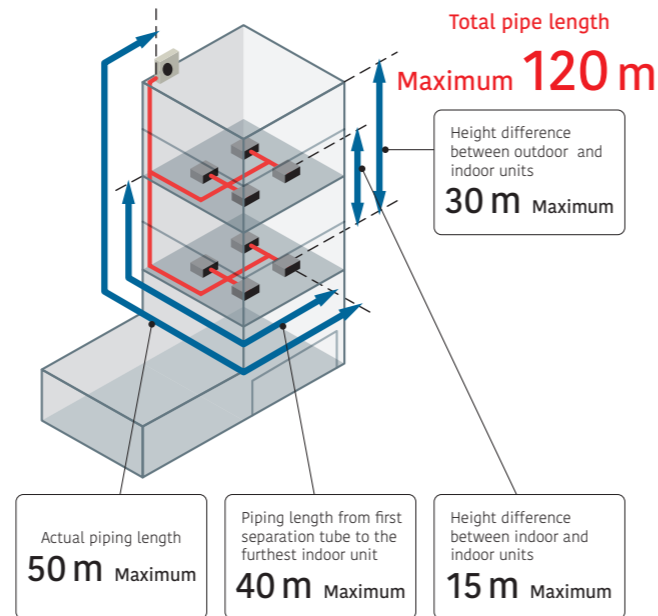
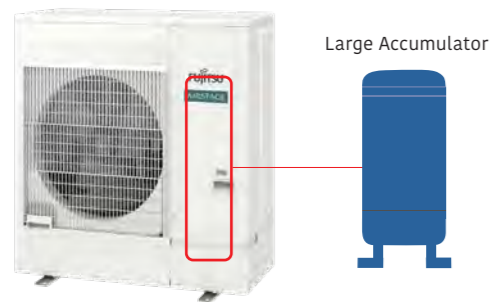

Specifications

Rated capacity range		HP	4	5	6
Model name			AJY040KCTAH	AJY045KCTAH	AJY054KCTAH
Maximum connectable indoor units			1-11	1-12	1-13
Power source			Single phase, ~230 V, 50 Hz		
Capacity	Cooling	kW	14.0	14.0	15.1
	Nominal Heating		12.1	14.0	15.1
	Max. Heating		13.6	16.0	16.5
Input power	Cooling	kW	3.15	3.82	4.48
	Nominal Heating		2.55	2.91	3.20
	Max. Heating		3.09	3.62	3.90
EER	Cooling	W/W	3.84	3.66	3.37
	Nominal Heating		4.74	4.80	4.71
	Max. Heating		4.40	4.41	4.22
SEER	Cooling		8.20	8.27	7.79
	Heating		5.37	4.93	4.82
SCOP	Cooling		325.0	328.0	308.6
	Heating		212.0	194.0	189.8
ηc	Cooling	%	4,240	4,450	4,450
	Heating		52 / 70	53 / 71	54 / 72
ηh	Cooling		54 / 71	55 / 72	56 / 73
	Heating		4,240	4,450	4,450
Airflow rate	Cooling	m³/h	52 / 70	53 / 71	54 / 72
	Heating		54 / 71	55 / 72	56 / 73
Sound pressure level/Power level	Cooling	dB(A)	Blue fin	Blue fin	Blue fin
	Heating		Blue fin	Blue fin	Blue fin
Net Dimensions	Height	mm	998	998	998
	Width		940	940	940
	Depth		320	320	320
Weight		kg	74	74	74
Refrigerant	Type (Global Warming Potential)	kg (CO2eq-T)	R32 (675)	R32 (675)	R32 (675)
	Charge		2.7 (1.823)	2.7 (1.823)	2.7 (1.823)
Connection pipe diameter	Liquid	mm	9.52	9.52	9.52
	Gas		15.88	15.88	15.88
Total pipe length		m	120	120	120
	Max. height difference		30	30	30
Operating Range	Cooling	°C	-5 to 46	-5 to 46	-5 to 46
	Heating		-20 to 21	-20 to 21	-20 to 21

Note: Specifications are based on the following conditions.
 Cooling: Indoor temperature of 27°CDB/19°CWB, and outdoor temperature of 35°CDB/24°CWB.
 Heating: Indoor temperature of 20°CDB/(15°CWB), and outdoor temperature of 7°CDB/6°CWB.
 Pipe length: 7.5 m; Height difference between outdoor unit and indoor unit: 0 m.
 The protective function may work when using it outside the operation range.

Up to 13 indoor units* can be connected

The combination of smaller but sufficiently powerful indoor units and a new outdoor unit with an optimized heat exchanging structure makes it possible to connect up to 13 indoor units, which is the best in its class.

*: 6 HP model

Rating Capacity range (HP)	4	5	6
Max. Connectable indoor unit	1-11	1-12	1-13

Sightliness installation

External static pressure

External static pressure measures up to 30 Pa for 4/5/6 HP models.

Even if the outdoor unit is installed in a small space to hide it, the grille and duct airflow path required for exhaust air can be installed up to a static pressure value of 30 Pa.

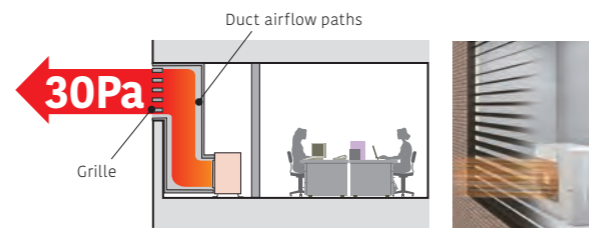

Cooling piping system

New Heat Rejection Technology Cooling piping system "Cooling piping system" is adopted to ensure reliability in high outside air.

Even when the outdoor unit is installed in an environment where heat tends to stay (small space), the cooling system using refrigerant can reduce damage caused by heat from PCBs.

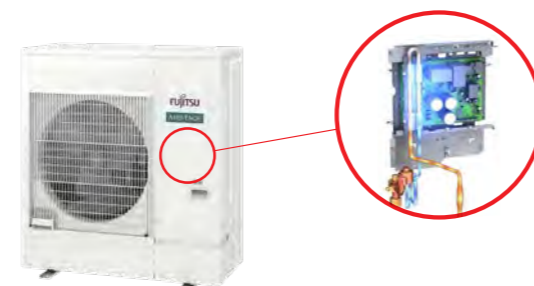

Dimensions

(Unit: mm)

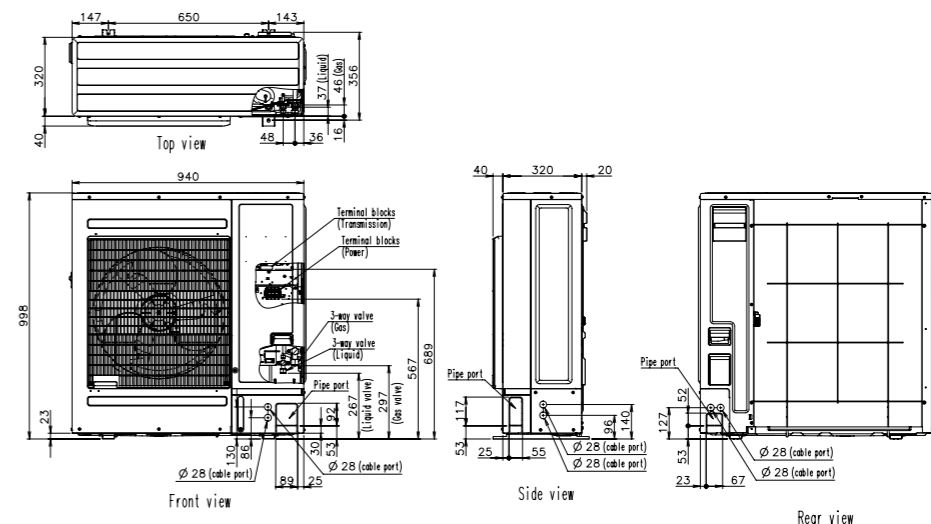



Heat Pump for Small-capacity type

VRF J-IVS

System configuration example

- Suitable for air conditioning small and medium-size buildings. One refrigerant system is used for each outdoor unit.
- Multiple indoor units are connected with separation tubes and headers.

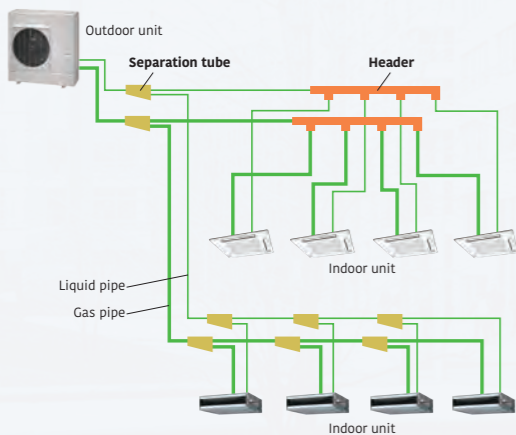

New intelligent refrigerant control

Fujitsu General is proposing outdoor units equipped with refrigerant control function. The refrigerant control operates with suitable control corresponding to the heat load of the room and offers a more comfortable environment. The refrigerant control can also provide increased energy savings.

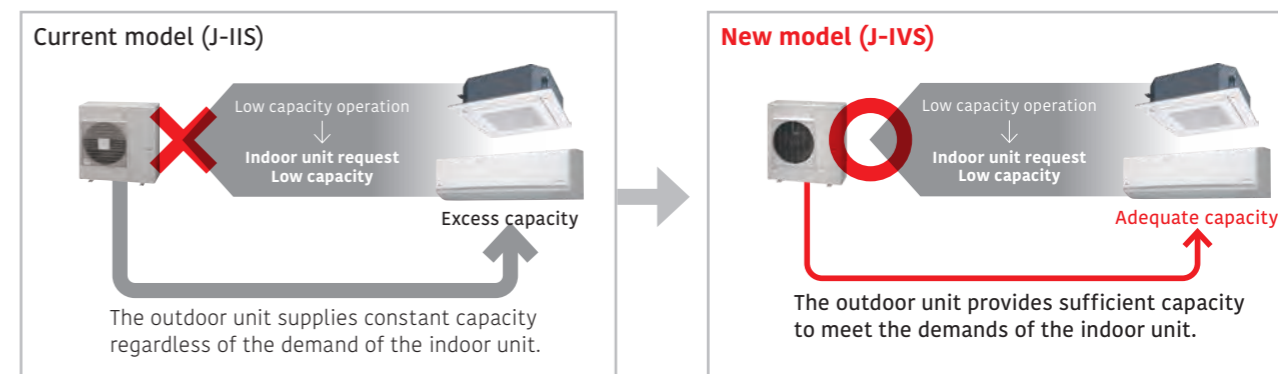

* The improvements due to the control and the actual sine wave vary depending on the combination of the indoor unit and system operating conditions.

External static pressure

External static pressure measures up to 25 Pa for 4/5/6 HP models.



Advanced high-efficiency technology



Large propeller fan
A large propeller fan with an optimized blade angle achieves both high performance and low noise operation.



DC fan motor
A small, multi-stage DC fan motor provides high-efficiency and low noise operation.

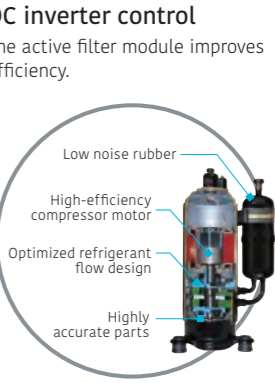

DC inverter control
The active filter module improves efficiency.

- Low noise rubber
- High-efficiency compressor motor
- Optimized refrigerant flow design
- Highly accurate parts

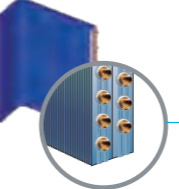

Large heat exchanger
The large 3-row heat exchanger substantially improves heat-exchanging performance.



High heat-transfer copper tube (Improved lead angle)

Compact and high-performance DC twin-rotary compressor

High-efficiency is achieved across compressor loads. Especially good performance is achieved in the low- to medium-load range.

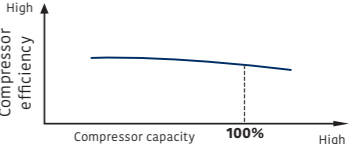

Easy to carry, easy to install

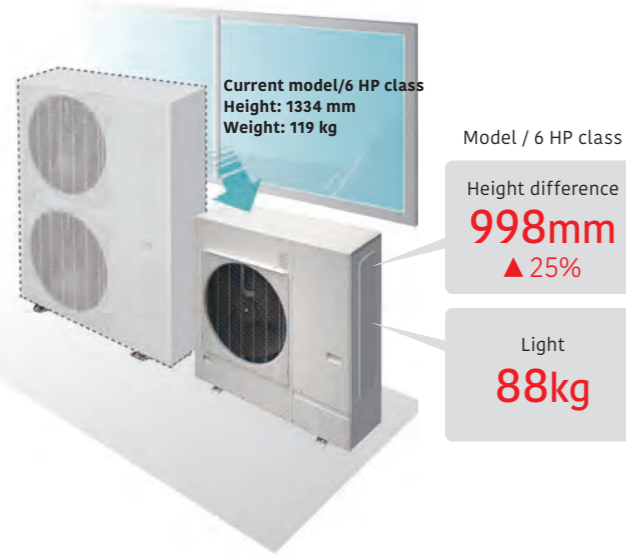

Small, lightweight outdoor unit

The outdoor units in this series are much more compact than conventional outdoor units of comparable capacity. They can be installed on a balcony, fitting below the height of the railing. With a height of less than 1 m, they can be installed in tight spaces such as under windows.



Low noise design

Significantly low noise levels are achieved by the use of a DC twin-rotary compressor, inverter technology, and an advanced airflow pattern design.



Long pipe length

Our advanced refrigerant control technology extends the maximum allowable length of refrigerant piping to 80 m. This provides high flexibility in system design.

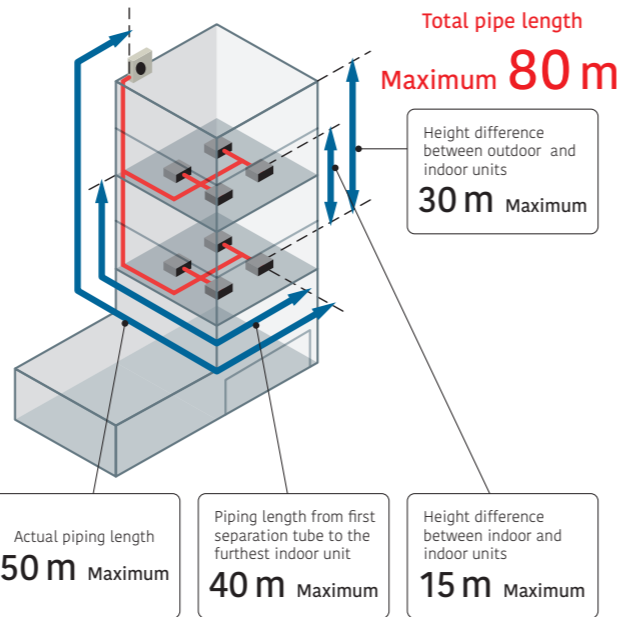

Up to 13 indoor units* can be connected

The combination of smaller but sufficiently powerful indoor units and a new outdoor unit with an optimized heat exchanging structure makes it possible to connect up to 13 indoor units, which is the best in its class.

*: 6 HP model

Model	Current model (J-IIS)			New model (J-IVS)		
	4	5	6	4	5	6
Rating Capacity range (HP)	4	5	6	4	5	6
Max. Connectable indoor unit	1-7	1-8	1-8	1-11	1-12	1-13

Non-stop oil recovery operation

A comfortable room condition is maintained during oil recovery mode because the product continues to operate without stopping the cooling or heating operation.

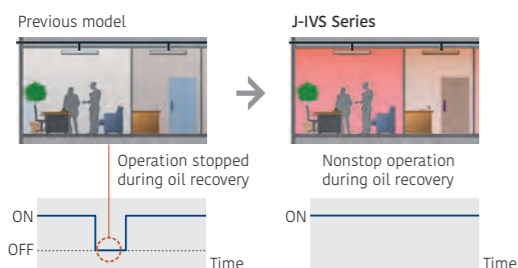

Easier installation

Connection check function: Wiring connections and address settings can be checked thanks to the quick check run function.

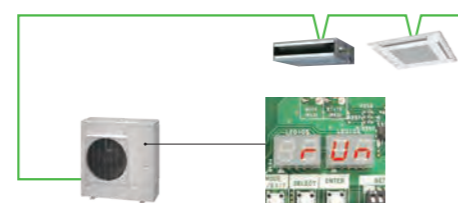

- Displays the number of each connected indoor unit.
- Displays the duplicate address number assigned to an indoor unit.

Specifications

Rated capacity range	HP	4	5	6
Model name		AJY040LCDH	AJY045LCDH	AJY054LCDH
Maximum connectable indoor units		1-11	1-12	1-13
Power source		Single phase, ~230 V, 50 Hz		
Capacity	Cooling	14.0	14.0	15.1
	Nominal Heating	12.1	14.0	15.1
	Max. Heating	13.6	16.0	16.5
Input power	Cooling	3.75	4.71	5.55
	Nominal Heating	3.22	3.77	4.33
	Max. Heating	3.99	5.04	5.32
EER	Cooling	3.22	2.97	2.72
	Nominal Heating	3.75	3.71	3.48
	Max. Heating	3.40	3.17	3.10
COP	Cooling	5.83	5.58	5.47
	Heating	3.82	3.96	3.99
SEER	Cooling	230.2	220.2	215.8
	Heating	149.8	155.4	156.6
SCOP	Cooling	4.240	4.400	4.400
	Heating	53 / 67	53 / 69	54 / 70
Airflow rate	Cooling	54 / 68	56 / 69	56 / 70
	Heating	Blue fin	Blue fin	Blue fin
Sound pressure level/Power level	Cooling	998	998	998
	Heating	970	970	970
	Height	370	370	370
Net Dimensions	Width	88	88	88
	Depth	R410A (2,088)	R410A (2,088)	R410A (2,088)
	Type (Global Warming Potential)	4.0 (8.4)	4.0 (8.4)	4.0 (8.4)
Refrigerant	Charge	9.52	9.52	9.52
	Liquid	15.88	15.88	15.88
	Gas	80	80	80
Connection pipe diameter	Liquid	30	30	30
	Gas	-5 to 46	-5 to 46	-5 to 46
Total pipe length	Cooling	-20 to 21	-20 to 21	-20 to 21
	Heating			
Max. height difference	Cooling			
	Heating			
Operating Range	Cooling			
	Heating			

Note: Specifications are based on the following conditions.
Cooling: Indoor temperature of 27°CDB/19°CWB, and outdoor temperature of 35°CDB/24°CWB.
Heating: Indoor temperature of 20°CDB/(15°CWB), and outdoor temperature of 7°CDB/6°CWB.
Pipe length: 7.5 m; Height difference between outdoor unit and indoor unit: 0 m.
The protective function may work when using it outside the operation range.

Dimensions

(Unit: mm)

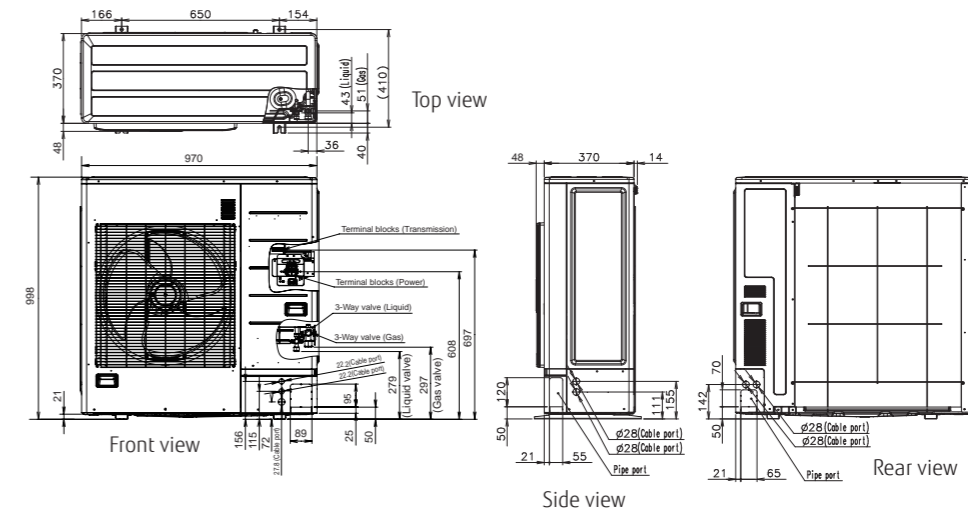



Heat Pump for Small-capacity type

VRF J-IV

System configuration example

- Suitable for air conditioning small and medium-size buildings. One refrigerant system is used for each outdoor unit.
- Multiple indoor units are connected with separation tubes and headers.

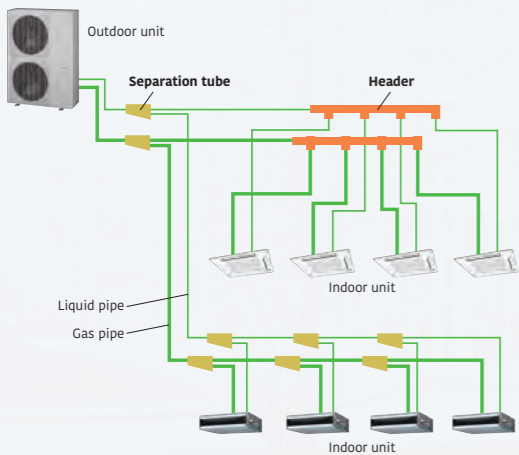

New intelligent refrigerant control

Fujitsu General is proposing outdoor units equipped with refrigerant control function. The refrigerant control operates with suitable control corresponding to the heat load of the room and offers a more comfortable environment. The refrigerant control can also provide increased energy savings.

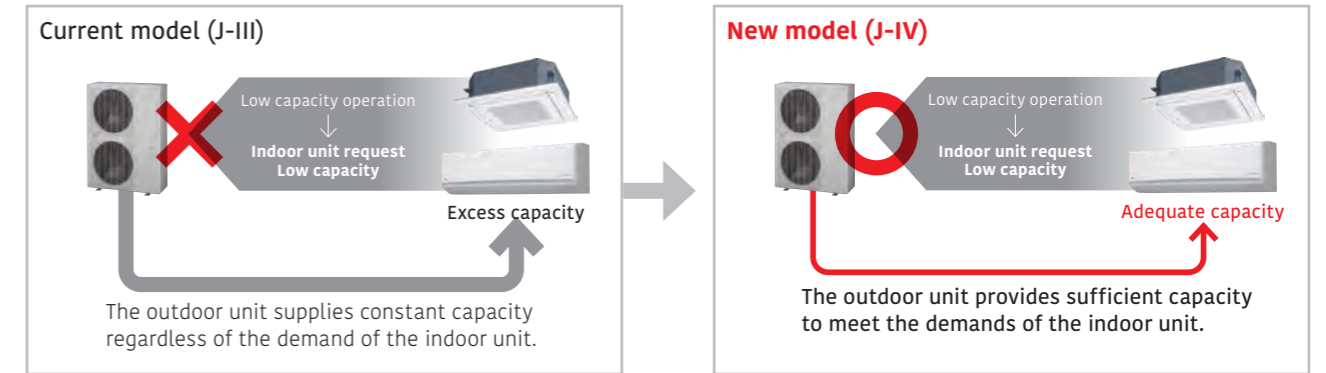

* The improvements due to the control and the actual sine wave vary depending on the combination of the indoor unit and system operating conditions.

External static pressure

External static pressure measures up to 30 Pa for 4/5/6 HP.



Advanced high-efficiency technology

Large propeller fan
A large propeller fan with an optimized blade angle achieves both high performance and low noise operation.

DC fan motor
A small, multi-stage DC fan motor contributes to high-efficiency and low noise operation.

Large heat exchanger
The large 3-row heat exchanger substantially improves heat-exchanging performance.

DC twin-rotary compressor
High-efficiency is achieved across compressor loads. Especially good performance is achieved in the low-to medium-load range.

Subcooling heat exchanger
The dual-tube heat exchanger improves cooling performance.

DC inverter control
The active filter module improves efficiency.

High-efficiency compressor motor
Optimized refrigerant flow design
Highly accurate parts

Pressure-Enthalpy graph: Shows 'effect' and 'Cooling performance improved'.

Compressor efficiency graph: Shows 'DC Twin-Rotary Compressor' with high efficiency across capacity.

Efficiency in actual operating conditions

The use of a large heat exchanger and a high-efficiency Scroll compressor achieves class-leading EER/COP (Max. Heating) in all models.

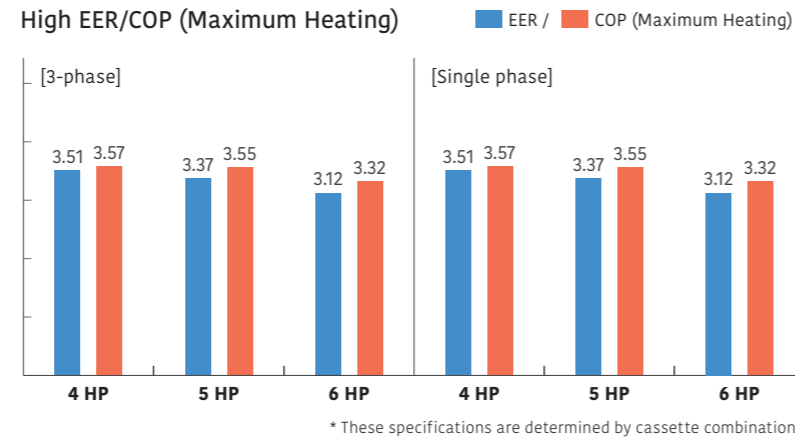

Long pipe length

Our advanced refrigerant control technology allows us to achieve a total refrigerant pipe length of 180 m. This provides high flexibility in system design.

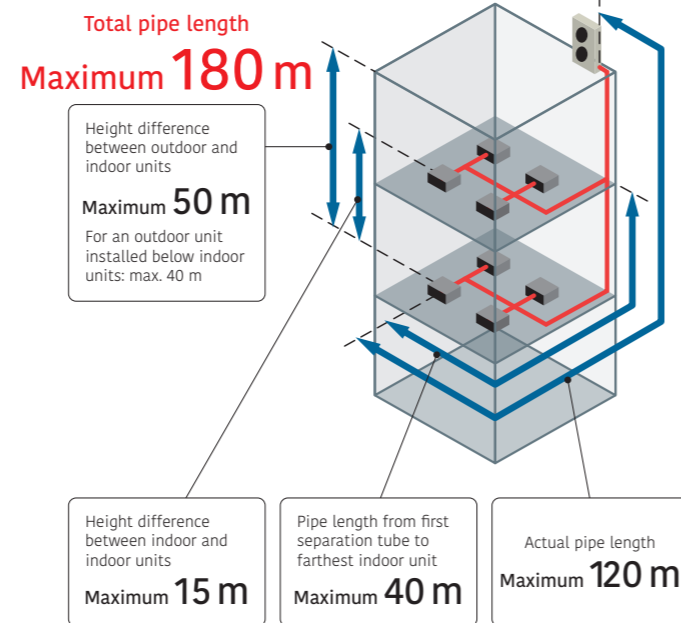

Up to 14 indoor units* can be connected

The combination of smaller but sufficiently powerful indoor units and outdoor units with an optimized heat exchanging structure makes it possible to connect up to 14 indoor units, which is the best in its class.

*: 6 HP model

Model	Current model (J-III)			New model (J-IV)		
	4	5	6	4	5	6
Rating Capacity range (HP)						
Max. Connectable indoor unit	1-9	1-10	1-13	1-11	1-12	1-14

4,5,6HP: AJY040LBDH / AJY045LBDH / AJY054LBDH AJY040LELDH [3-phase] / AJY045LELDH [3-phase] / AJY054LELDH [3-phase]

Specifications

Rated capacity range		HP	4	5	6	4	5	6
Model name			AJY040LBDH	AJY045LBDH	AJY054LBDH	AJY040LELDH	AJY045LELDH	AJY054LELDH
Maximum connectable indoor units			1-11	1-12	1-14	1-11	1-12	1-14
Power source			Single phase, ~230 V, 50 Hz			3-phase, ~400 V, 50 Hz		
Capacity	Cooling	kW	12.1	14.0	15.5	12.1	14.0	15.5
	Nominal Heating		12.1	14.0	15.5	12.1	14.0	15.5
	Max. Heating		13.6	16.0	18.0	13.6	16.0	18.0
Input power	Cooling	kW	3.44	4.15	4.96	3.44	4.15	4.96
	Nominal Heating		3.14	3.60	4.17	3.14	3.60	4.17
	Max. Heating		3.80	4.50	5.41	3.80	4.50	5.41
EER	Cooling		3.51	3.37	3.12	3.51	3.37	3.12
COP	Nominal Heating	W/W	3.85	3.88	3.71	3.85	3.88	3.71
	Max. Heating		3.57	3.55	3.32	3.57	3.55	3.32
	SEER		Cooling	6.50	6.30	6.08	6.50	6.30
SCOP	Heating		3.83	3.93	3.94	3.83	3.93	3.94
ηc	Cooling	%	257.0	249.0	240.0	257.0	249.0	240.0
ηh	Heating		150.0	154.0	155.0	150.0	154.0	155.0
Airflow rate		m³/h	6,200	6,600	7,000	6,200	6,600	7,000
Sound pressure level/ Power level	Cooling	dB(A)	50 / 65	52 / 66	53 / 67	50 / 65	52 / 66	53 / 67
	Heating		52 / 67	55 / 69	56 / 69	52 / 67	55 / 69	56 / 69
Heat exchanger fin			Blue fin	Blue fin	Blue fin	Blue fin	Blue fin	Blue fin
Net Dimensions	Height	mm	1,334	1,334	1,334	1,334	1,334	1,334
	Width		970	970	970	970	970	970
	Depth		370	370	370	370	370	370
Weight		kg	117	117	119	118	119	119
	Refrigerant	Type (Global Warming Potential)	R410A (2,088)	R410A (2,088)	R410A (2,088)	R410A (2,088)	R410A (2,088)	R410A (2,088)
Charge		kg (CO2eq-T)	4.8 (10.0)	5.3 (11.1)	5.3 (11.1)	4.8 (10.0)	5.3 (11.1)	5.3 (11.1)
Connection pipe diameter	Liquid	mm	9.52	9.52	9.52	9.52	9.52	9.52
	Gas		15.88	15.88	19.05	15.88	15.88	19.05
Total pipe length		m	180	180	180	180	180	180
Max. height difference			50/40 (Outdoor unit: Upper/Lower)			50/40 (Outdoor unit: Upper/Lower)		
Operating Range	Cooling	°C	-5 to 46	-5 to 46	-5 to 46	-5 to 46	-5 to 46	-5 to 46
	Heating		-20 to 21	-20 to 21	-20 to 21	-20 to 21	-20 to 21	-20 to 21

Note: Specifications are based on the following conditions.
Cooling: Indoor temperature of 27°CDB/19°CWB, and outdoor temperature of 35°CDB/24°CWB.
Heating: Indoor temperature of 20°CDB/(15°CWB), and outdoor temperature of 7°CDB/6°CWB.
Pipe length: 7.5 m; Height difference between outdoor unit and indoor unit: 0 m.
The protective function may work when using it outside the operation range.

Dimensions

(Unit: mm)

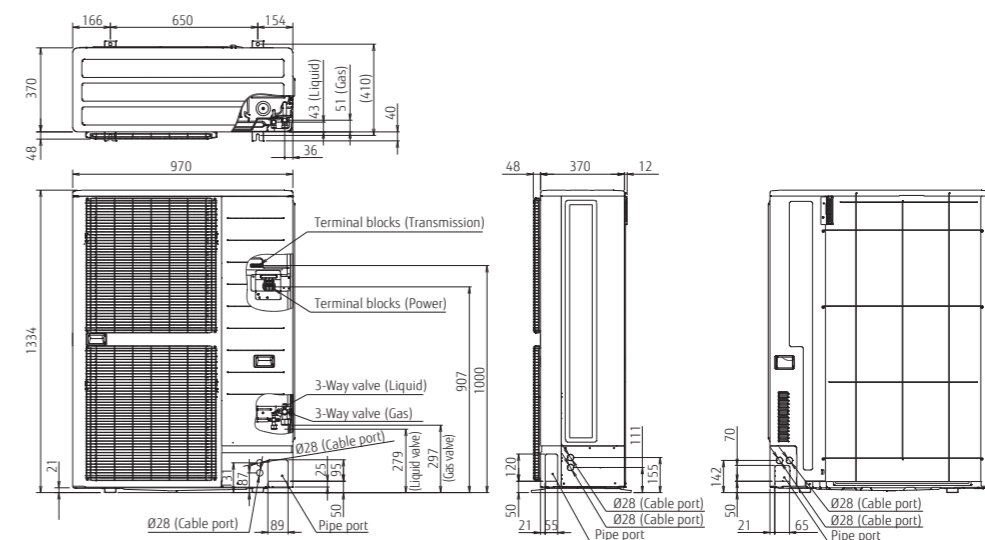

Non-stop oil recovery operation

A comfortable room condition is maintained during oil recovery mode because the product continues to operate without stopping the cooling or heating operation.

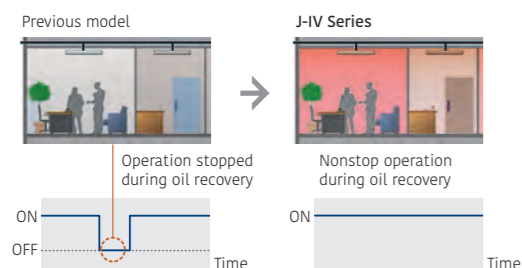

Easier installation

Connection check function: Wiring connections and address settings can be checked thanks to the quick check run function.

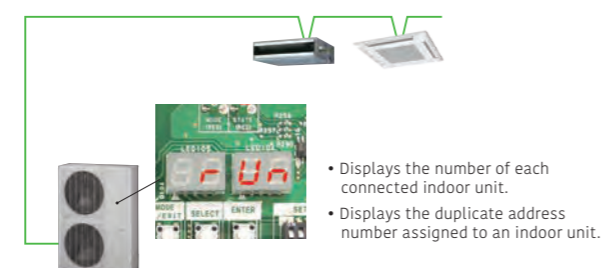



Heat Pump for Small-capacity type

VRF J-IVL

System configuration example

- Suitable for air conditioning small and medium-size buildings. One refrigerant system is used for each outdoor unit.
- Multiple indoor units are connected with separation tubes and headers.

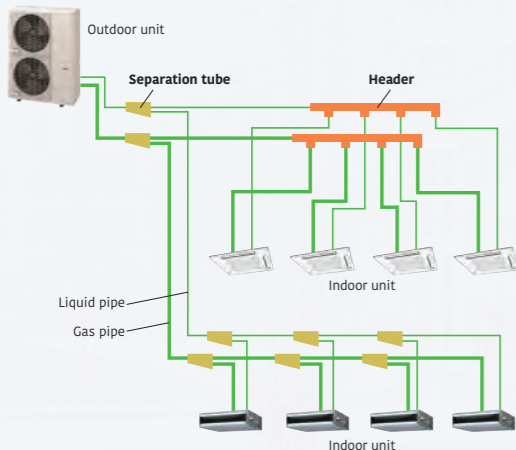

New intelligent refrigerant control

Fujitsu General is proposing outdoor units equipped with refrigerant control function. The refrigerant control operates with suitable control corresponding to the heat load of the room and offers a more comfortable environment. The refrigerant control can also provide increased energy savings.

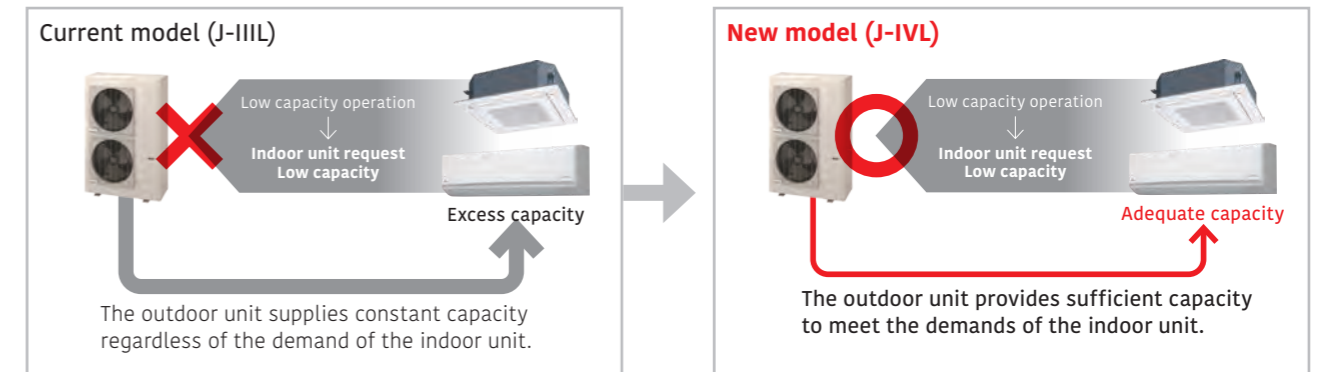

* The improvements due to the control and the actual sine wave vary depending on the combination of the indoor unit and system operating conditions.

External static pressure

External static pressure is available up to 60 Pa for 14/16/18 HP. (30 Pa for 8/10 HP, 40 Pa for 12 HP)
Capacities are slightly decreased relative to the rated values during high static pressure operations.



Advanced high-efficiency technology

Ø570 mm Large propeller fan
A large-diameter propeller fan with our proprietary blade design reduces draft loss, which results in high-efficiency and low noise operation.

DC inverter control
The active filter module improves efficiency.

DC fan motor
A small, multi-stage DC fan motor provides high-efficiency and low noise operation.

Subcooling heat exchanger
The dual-tube heat exchanger improves cooling performance.

Large heat exchanger
The large 2.6-row heat exchanger substantially improves heat-exchanging performance.

Scroll compressor
The combination of a scroll compressor with a wide rotational frequency range from 15 to 130 rps and our proprietary sensorless sine-wave control that smoothly controls the input power into the motor achieves more energy-efficient and quieter operation.



Fujitsu General offers a perfect total air conditioning system for small office buildings with multiple small rooms, taking into consideration energy savings, low noise, comfortable air volume, usage and purpose, and centralized control.

VRF **J-IVL**

Image: 8/10/12 HP models

Slim & Compact design

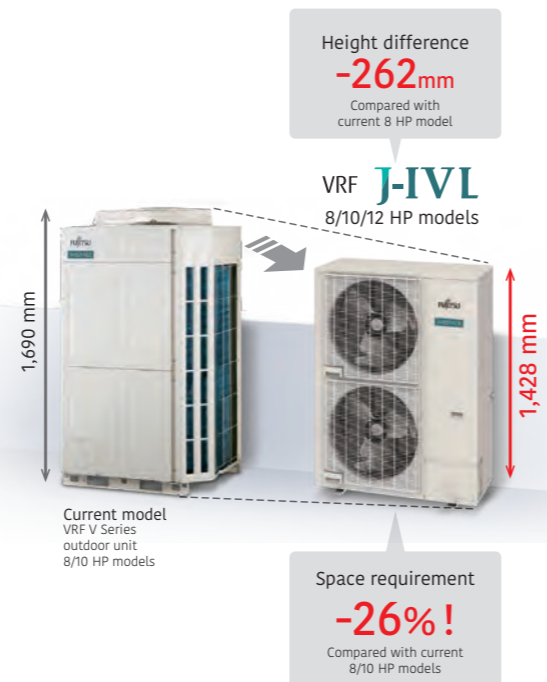
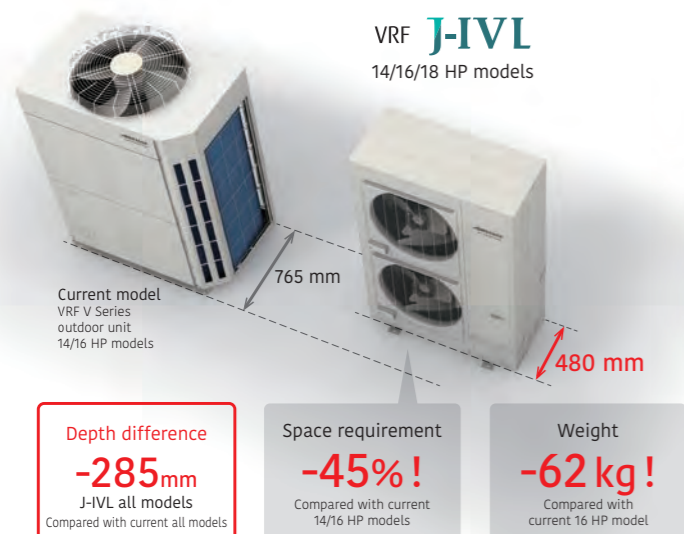

Various installation methods

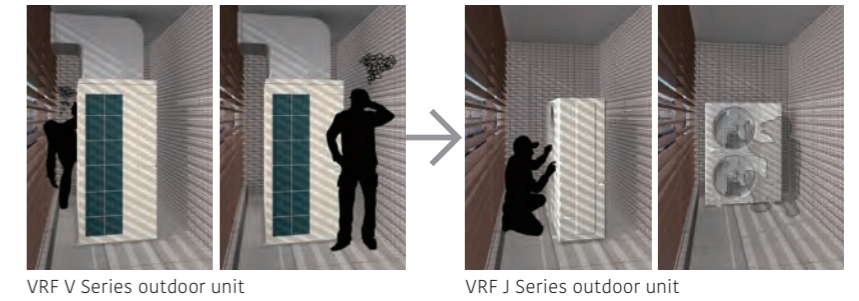

Installation
Low noise level in consideration of nearby residents
Front air discharge type with a width of about 1,000 mm, allowing for flexible installation even in narrow spaces.



Narrow space behind building
Space saving
Small and thin, allowing for direct ground or wall mounting installations even in narrow alleys.



Installation on the back street of a building
Flexible installation
Slim, low-body front air discharge meets the requirements for installation even in tight spaces. Installation flexibility without blocking the windows of buildings contributes to substantial space savings, even when multiple units are installed.

Efficiency in actual operating conditions

The use of a large heat exchanger and a high-efficiency Scroll compressor achieves class-leading EER/COP (Max. Heating) in all models.

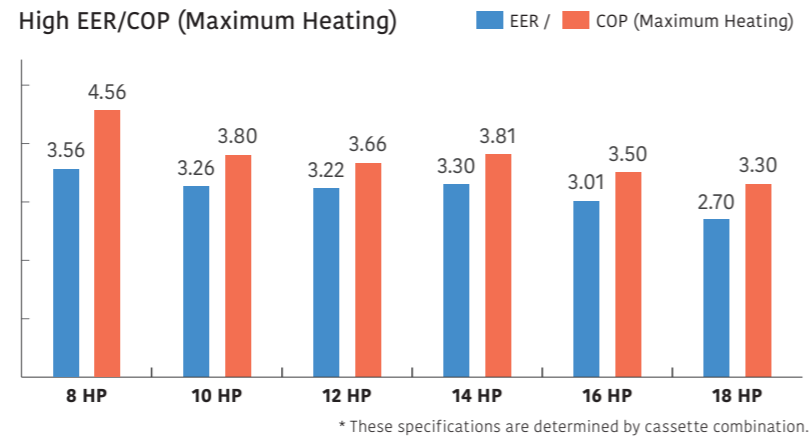

Long pipe length

Our advanced refrigerant control technology extends the maximum allowable length of refrigerant piping to 400 m. This provides high flexibility in system design.

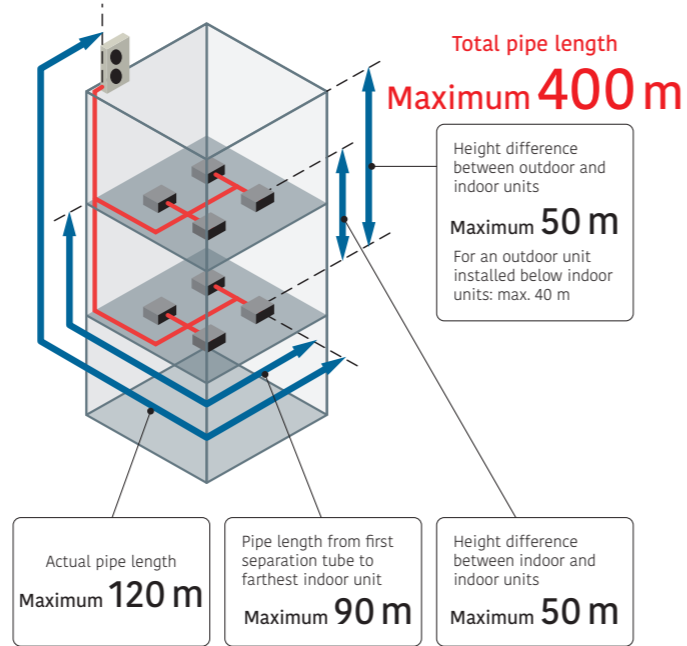

Up to 42 indoor units* can be connected.

The combination of smaller but sufficiently powerful indoor units and a new outdoor unit with an optimized heat exchanging structure makes it possible to connect up to 42 indoor units, which is the best in its class.

*: 18 HP model



Class-leading low operating sound

The top-class low operating noise makes it ideal for use in densely populated areas. These low operating sound models are ideal for installation in densely populated areas.

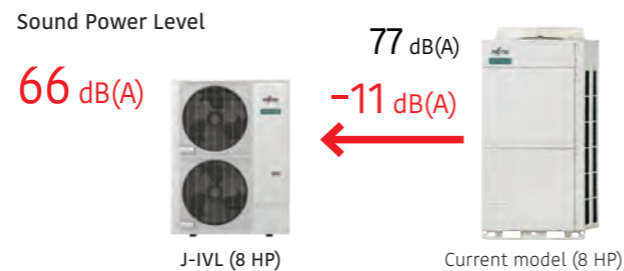

8,10,12 HP: AJY072LELDH / AJY090LELDH / AJY108LELDH 14,16,18 HP: AJY126LELDH / AJY144LELDH / AJY162LELDH



Specifications

Rated capacity range		HP	8	10	12	14	16	18
Model name			AJY072LELDH	AJY090LELDH	AJY108LELDH	AJY126LELDH	AJY144LELDH	AJY162LELDH
Maximum connectable indoor units			1-20	1-25	1-30	1-36	1-40	1-42
Power source			3-phase, ~400V, 50Hz					
Capacity	Cooling	kW	22.4	28.0	33.5	40.0	45.0	50.0
	Nominal Heating	kW	22.4	28.0	33.5	40.0	45.0	50.0
	Max. Heating	kW	25.0	31.5	37.5	45.0	50.0	55.0
Input power	Cooling	kW	6.30	8.59	10.42	12.12	14.96	18.52
	Nominal Heating	kW	4.65	6.61	8.18	9.71	11.81	13.66
	Max. Heating	kW	5.45	8.29	10.25	11.81	14.29	16.66
EER	Cooling		3.56	3.26	3.22	3.30	3.01	2.70
	Nominal Heating	W/W	4.82	4.24	4.10	4.12	3.81	3.66
COP	Max. Heating	W/W	4.56	3.80	3.66	3.81	3.50	3.30
	SEER	Cooling	7.62	7.50	7.27	7.27	7.00	6.29
SCOP	Heating		3.89	3.61	3.63	3.53	3.51	3.54
	ηc	Cooling	301.8	297.0	287.8	287.8	277.0	248.6
ηh	Heating	%	152.6	141.4	142.2	138.2	137.4	138.6
	Airflow rate	m³/h	8,400	9,000	11,000/12,100	13,000	14,000	14,800/15,300
Sound pressure level/Power level	Cooling	dB(A)	52/66	54/69	59/73	62/75	64/77	65/79
	Heating	dB(A)	54/66	57/70	62/75	63/76	65/78	68/82
Net Dimensions	Height	mm	1,428	1,428	1,428	1,638	1,638	1,638
	Width	mm	1,080	1,080	1,080	1,080	1,080	1,080
	Depth	mm	480	480	480	480	480	480
Weight		kg	170	177	178	213	213	217
	Refrigerant	Type (Global Warming Potential)	R410A (2,088)	R410A (2,088)	R410A (2,088)	R410A (2,088)	R410A (2,088)	R410A (2,088)
Connection pipe diameter	Charge	kg (CO2eq-T)	7.0 (14.6)	7.5 (15.7)	7.5 (15.7)	11.0 (23.0)	11.0 (23.0)	11.8 (24.6)
	Liquid	mm	9.52	9.52	12.70	12.70	12.70	12.70
Total pipe length	Gas	mm	19.05	22.20	28.58	28.58	28.58	28.58
	Max. height difference	m	400	400	400	400	400	400
Operating Range	Cooling	°C	-15 to 46	-15 to 46	-15 to 46	-5 to 46*	-5 to 46*	-5 to 46*
	Heating	°C	-20 to 21	-20 to 21	-20 to 21	-20 to 21	-20 to 21	-20 to 21

Note: Specifications are based on the following conditions.
Cooling: Indoor temperature of 27°CDB / 19°CWB, and outdoor temperature of 35°CDB / 24°CWB.
Heating: Indoor temperature of 20°CDB / (15°CWB), and outdoor temperature of 7°CDB / 6°CWB.
Pipe length: 7.5 m; Height difference between outdoor unit and indoor unit: 0 m.
* The cooling operation range of -15 to 46°C is allowed only when all of the indoor units connected to the system are higher than capacity of 5.6kW.

Dimensions

(Unit: mm)

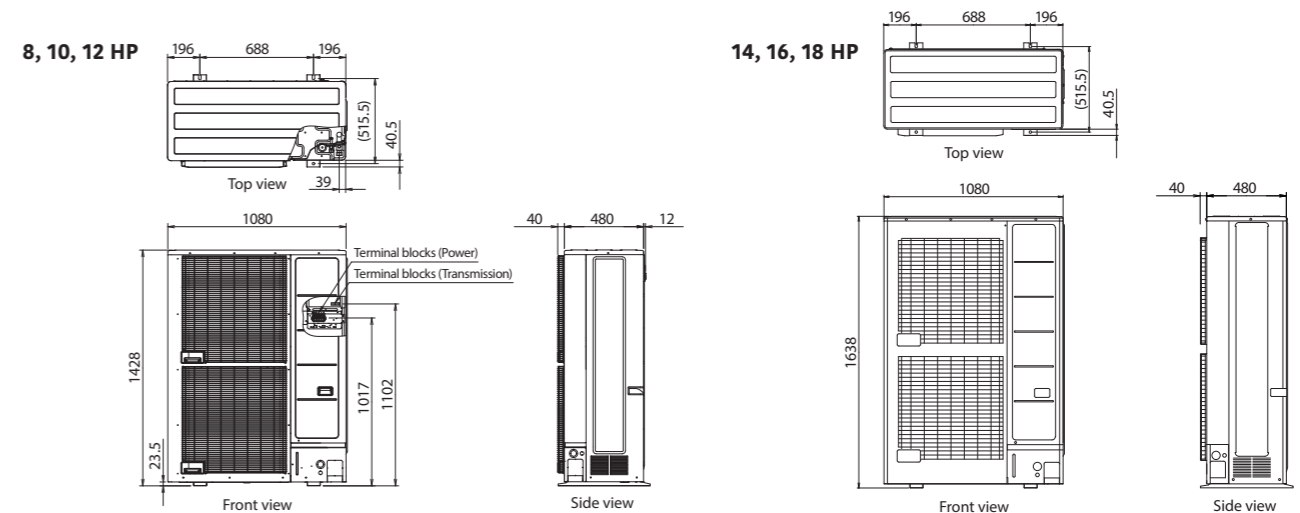



Heat Recovery
Modular type

VRF **VR-IV**

Highly energy-efficient operation

Our heat recovery systems achieve high operating energy efficiency by drawing heat from the room to be cooled and transferring it as energy for rooms that are to be heated.

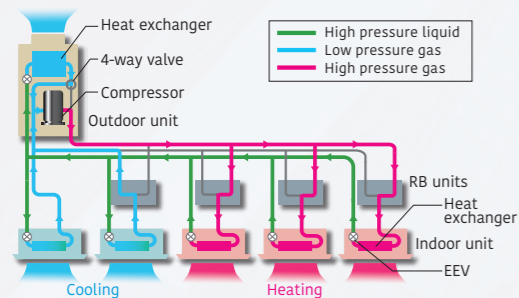

Our heat recovery systems achieve high operating energy efficiency by drawing heat from the room to be cooled and transferring it as energy for rooms that are to be heated.

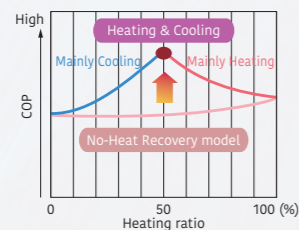

New intelligent refrigerant control

Fujitsu General is proposing outdoor units equipped with refrigerant control function. The refrigerant control operates with suitable control corresponding to the heat load of the room and offers a more comfortable environment. The refrigerant control can also provide increased energy savings.

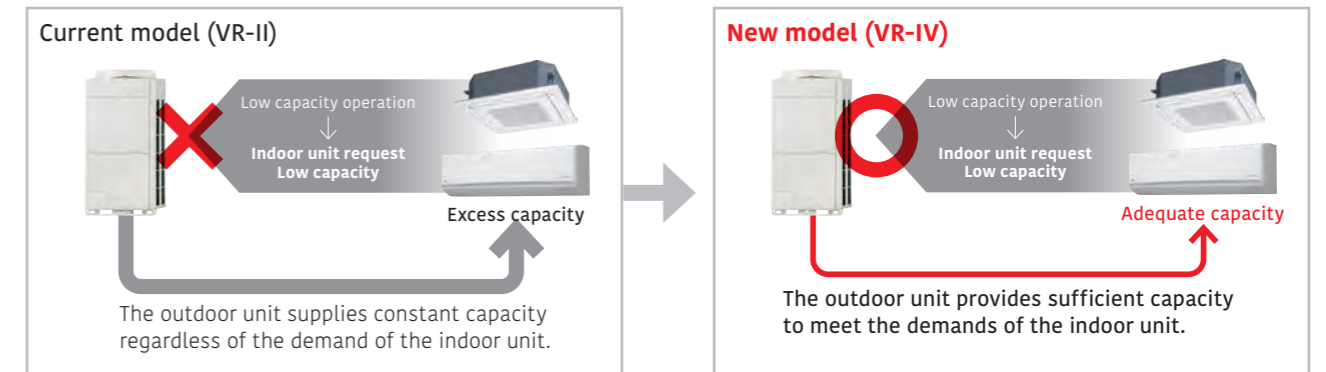

* The improvements due to the control and the actual sine wave vary depending on the combination of the indoor unit and system operating conditions.

Increase in the number of connectable indoor units

Capacity range of connectable indoor units

New model (VR-IV)	25%* to 150%
Current model (VR-II)	50% to 150%

*: For modular type, 25% to 49.9% operation in the entire system is available. (by one unit operation)

Increased number of connectable indoor units and space saving combinations (Unit)

HP	10	12	14	16	...	28	30	32	...	48	
New model (VR-IV)	21	26	30	34	...	60	64	64	...	64	
Current model (VR-II)	15	16	17	21	24	...	42	45	48	...	64

The energy-saving technology that boosted operation efficiency

- Powerful large propeller fan**
The fan uses CFD* technology to achieve both high performance and low noise operation.
*CFD: Computational Fluid Dynamics
- 3-phase DC fan motor**
The use of a DC fan motor with sophisticated driver control improves energy efficiency substantially. In addition, this motor operates quietly.
- Subcooling heat exchanger**
High heat exchange efficiency is achieved by using an internal projection-shape double-pipe construction.
- High-efficient, large-capacity DC twin-rotary compressor**
Large-capacity high-efficient DC twin-rotary compressor with excellent intermediate capability.
- Sine-wave DC inverter control**
High-efficiency is realized by the adoption of reduced switching loss IPM.
- 4-face heat exchanger**
The 4-face heat exchanger increases the effective surface area and significantly improves heat-exchanging efficiency.
- Front intake port (Corner cut air inlet structure)**
In multiple outdoor unit installations, the unique front intake design improves airflow into the heat exchanger.

Extended connection ratio (applicable to multiple tenants)

Especially useful when starting partial air conditioning in a building under construction. Installation can be added flexibly for each tenant.



Stand-alone

Current model (VR-II)

Example 50% of 12HP minimum connected indoor unit capacity is required

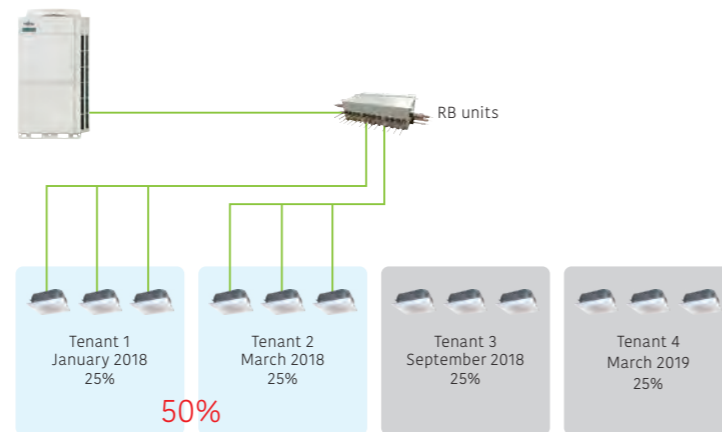

Installation is possible even for tenants who have not yet started operations.

New model (VR-IV)

Example 25% of 12HP minimum connected indoor unit capacity is required

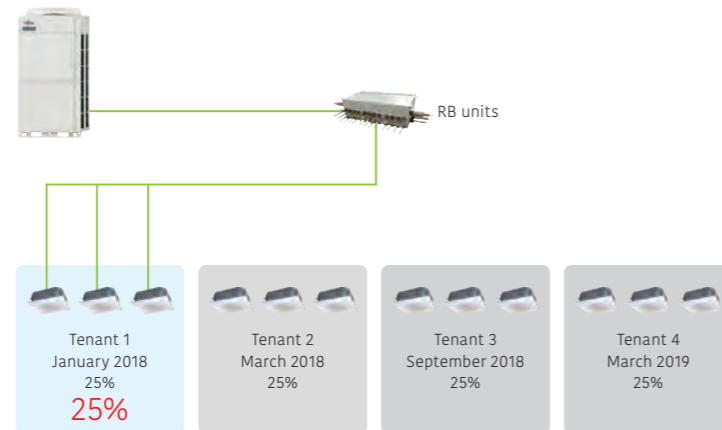

Installation and commissioning can be added flexibly to meet the opening dates of other tenants.

Modular type

One outdoor unit operates effectively for the capacities of connectable indoor units in the entire system. (Each of the multiple outdoor units does not dare to operate at 25% capacity: any one of the outdoor units will operate at 50% and the remaining units will each output 0%, i.e., stop operating.)

Example: One 10HP outdoor unit performs 25% of the total 20HP outdoor units system.
One 10HP outdoor unit performs 50% of its capacity
→ Two outdoor units do not perform 25% of the operation.



Additional installation is possible without changing the main pipe.

A main pipe of a diameter that can be used for the final system is installed at the beginning of the installation. Duplication of the work will be avoided as there is no need to change the main pipe as in the previous model.

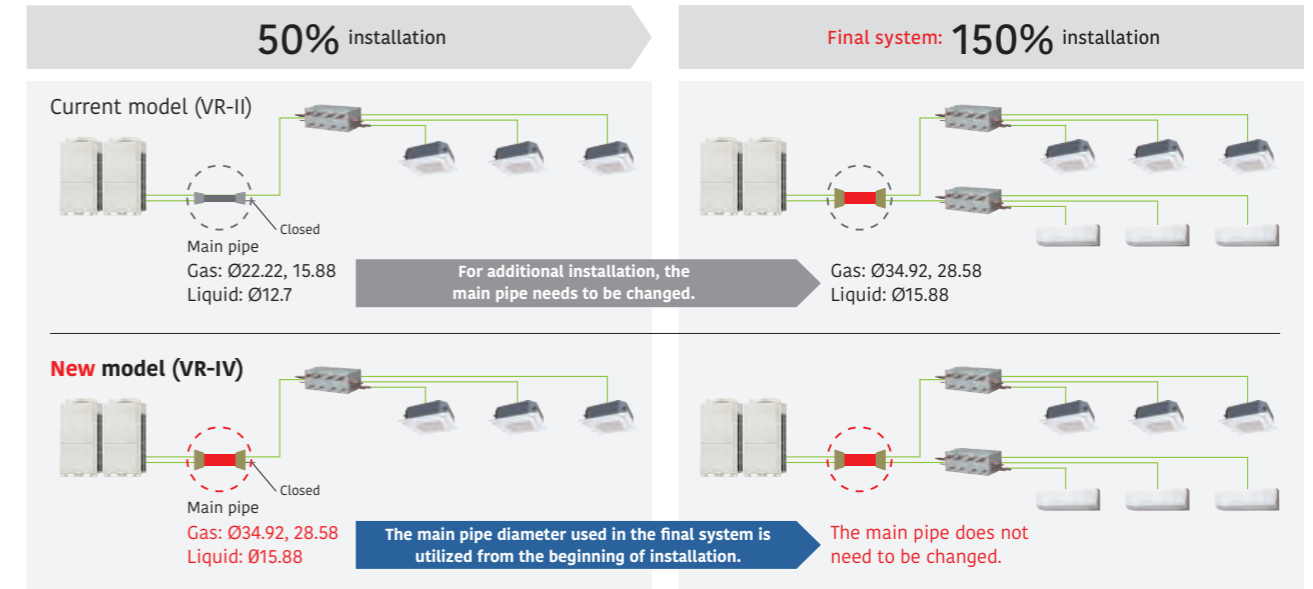

All-inverter compressor

Large-capacity DC inverter compressor

Large-capacity high-efficient DC twin-rotary compressor with excellent intermediate capability.



High-efficiency compressor speed control

The compressor speed control in 0.1 Hz increments ensures a comfortable space with less change in room temperature and less energy loss.

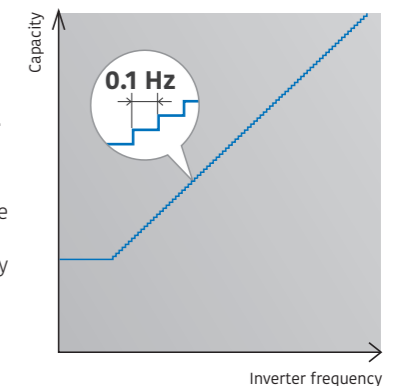

Efficiency in actual operating conditions

Class-leading high COP (Maximum) The use of our proprietary heat exchanger structure and high-efficiency DC twin-rotary compressors achieves the class-leading coefficient of performance (COP) in every combination.

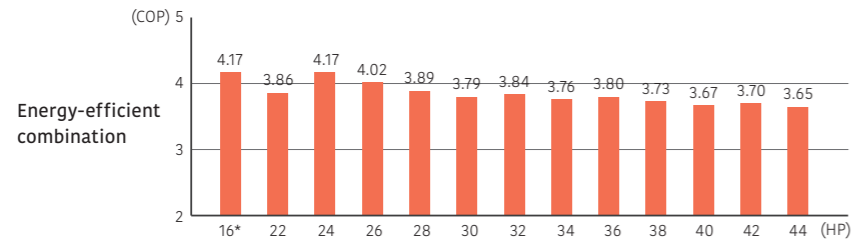
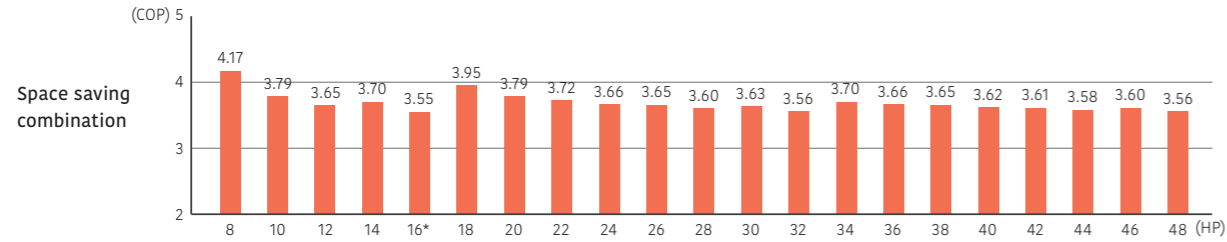

* These specifications are determined by Cassette combination.
* Multiple outdoor units are not certified by Eurovent.

Multiple outdoor operation control

When multiple outdoor units are connected, each compressor carries out sophisticated operation. Instead of operating one compressor at full load to distribute the refrigerant to one heat exchanger, all compressors operate at partial load to distribute the refrigerant to all heat exchangers, thereby improving the efficiency of the entire system.

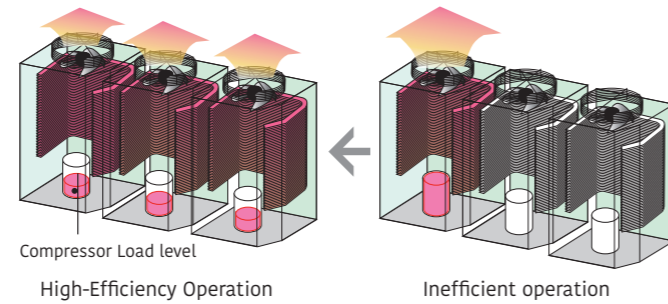

Heat exchanger refrigerant control

The heat exchanger in the outdoor unit is divided into two parts, upper and lower. The efficiency of the heat exchanger has been improved by adopting an optimum refrigerant path control where the refrigerant is distributed more into the top heat exchanger as this is where there is a greater air flow intake.

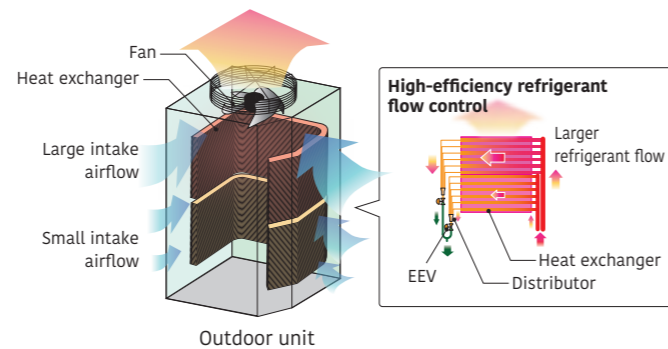

Flexible pipe connection

More flexible refrigerant pipe work is possible due to the use of various piping and RB unit connections, for adjustments to the floor layout and building structure.

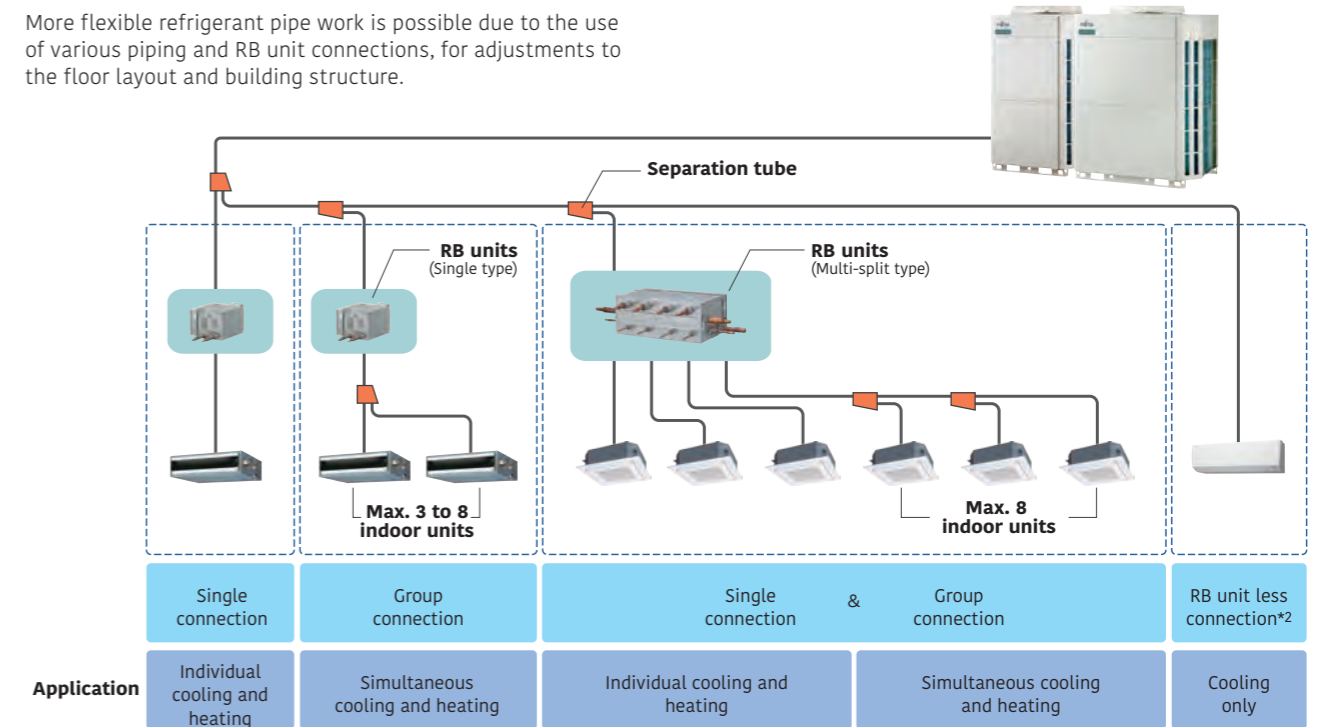

• An RB unit can be placed between the first branch and an indoor unit.
• The maximum height difference between RB units is 15 m.
No RB Unit is required for cooling only use.

Flexible installation of RB unit

Small and slim design with a height of 198 mm makes it easy to install in tight spaces with height constraints.

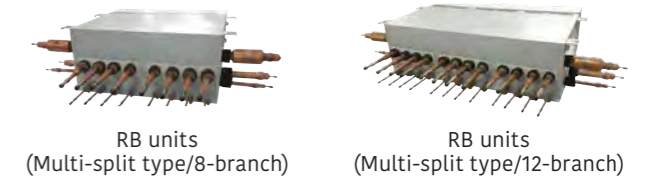

- A drain pipe is not required.
- Different positions of a control box can be chosen to accommodate installation conditions.
- Series connection for simplified installation

*: RB unit (single type)



Easy maintenance in tight spaces

Maintenance can be performed from the side.

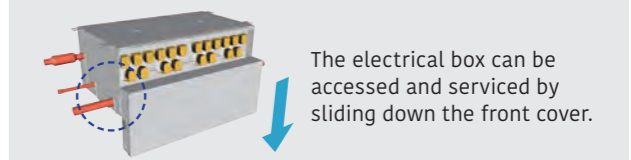

Parts can be accessed and replaced easily even in tight spaces inside the ceiling.

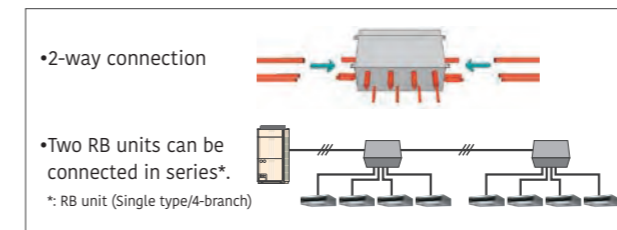
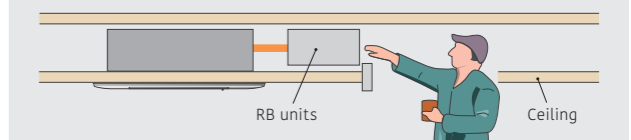

Outdoor units lineup • Combinations other than those listed below are not recommended.

Space saving combination

22.4kW (8HP) AJY072GALDH UNIT : AJY072GALDH	28.0kW (10HP) AJY090GALDH UNIT : AJY090GALDH	33.5kW (12HP) AJY108GALDH UNIT : AJY108GALDH	40.0kW (14HP) AJY126GALDH UNIT : AJY126GALDH	45.0kW (16HP) AJY144GALDH UNIT : AJY144GALDH
50.4kW (18HP) AJY162GALDH UNIT : AJY090/072GALDH	56.0kW (20HP) AJY180GALDH UNIT : AJY090/090GALDH	61.5kW (22HP) AJY198GALDH UNIT : AJY108/090GALDH	67.0kW (24HP) AJY216GALDH UNIT : AJY108/108GALDH	73.0kW (26HP) AJY234GALDH UNIT : AJY144/090GALDH
78.5kW (28HP) AJY252GALDH UNIT : AJY144/108GALDH	85.0kW (30HP) AJY270GALDH UNIT : AJY144/126GALDH	90.0kW (32HP) AJY288GALDH UNIT : AJY144/144GALDH	95.0kW (34HP) AJY306GALDH UNIT : AJY108/108/090GALDH	100.5kW (36HP) AJY324GALDH UNIT : AJY108/108/108GALDH
106.5kW (38HP) AJY342GALDH UNIT : AJY144/108/090GALDH	112.0kW (40HP) AJY360GALDH UNIT : AJY144/108/108GALDH	118.0kW (42HP) AJY378GALDH UNIT : AJY144/144/090GALDH	123.5kW (44HP) AJY396GALDH UNIT : AJY144/144/108GALDH	130.0kW (46HP) AJY414GALDH UNIT : AJY144/144/126GALDH
135.0kW (48HP) AJY432GALDH UNIT : AJY144/144/144GALDH				

Energy efficiency combination

44.8kW (16HP) AJY144GALDHH UNIT : AJY072/072GALDH	62.4kW (22HP) AJY198GALDHH UNIT : AJY126/072GALDH	67.2kW (24HP) AJY216GALDHH UNIT : AJY072/072/072GALDH	72.8kW (26HP) AJY234GALDHH UNIT : AJY090/072/072GALDH	78.4kW (28HP) AJY252GALDHH UNIT : AJY090/090/072GALDH
84.0kW (30HP) AJY270GALDHH UNIT : AJY090/090/090GALDH	90.4kW (32HP) AJY288GALDHH UNIT : AJY126/090/072GALDH	96.0kW (34HP) AJY306GALDHH UNIT : AJY126/090/090GALDH	102.4kW (36HP) AJY324GALDHH UNIT : AJY126/126/072GALDH	108.0kW (38HP) AJY342GALDHH UNIT : AJY126/126/090GALDH
113.0kW (40HP) AJY360GALDHH UNIT : AJY144/126/090GALDH	120.0kW (42HP) AJY378GALDHH UNIT : AJY126/126/126GALDH	125.0kW (44HP) AJY396GALDHH UNIT : AJY144/126/126GALDH		

8,10,12HP : AJY072GALDH / AJY090GALDH / AJY108GALDH
14,16HP : AJY126GALDH / AJY144GALDH



8, 10, 12 HP

14, 16 HP

Dimensions

(Unit: mm)

8, 10, 12 HP

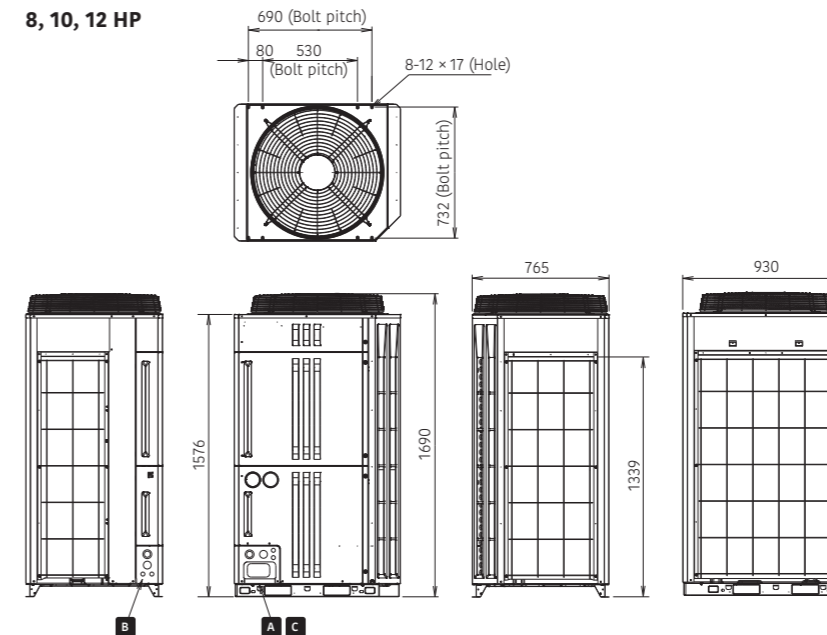

14, 16 HP

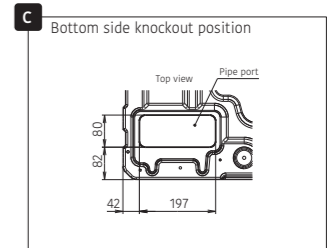
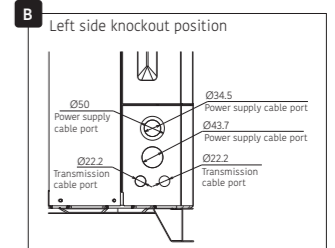
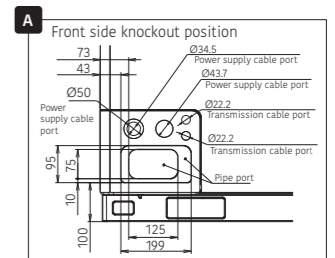
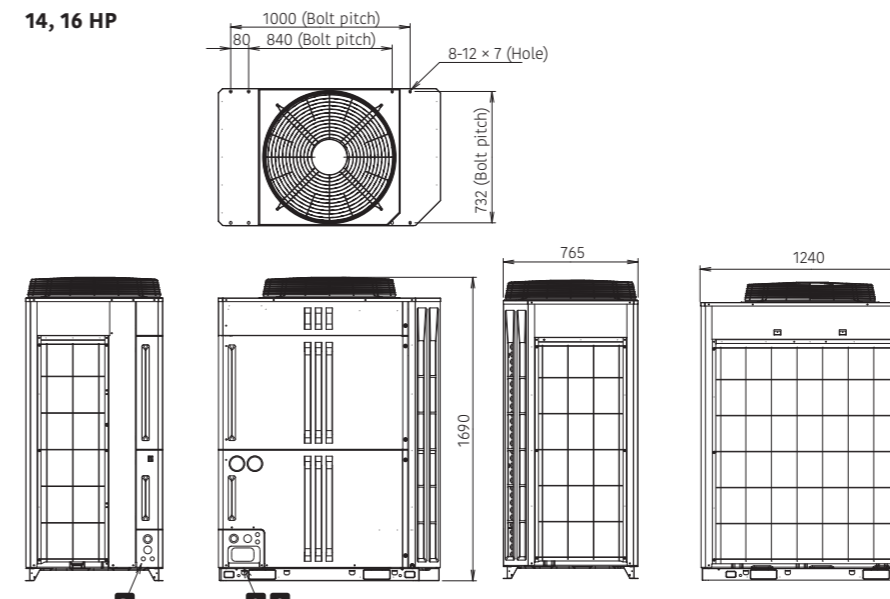

Outdoor units specifications

Space saving combination

Table with 22 columns (HP 8 to 48) and multiple rows (Model name, Unit 1, Unit 2, Unit 3, Maximum connectable indoor units*1, Capacity, Input power, EER, COP, SEER, SCOP, ηc, ηh, Air flow rate, Sound pressure level*2/ Power level, Max. External static pressure, Compressor motor output, Heat exchanger fin, Net Dimensions, Weight, Refrigerant, Connection pipe diameter, Operating Range).

Energy Efficiency Combination

Table with 14 columns (HP 16 to 44) and multiple rows (Model name, Unit 1, Unit 2, Unit 3, Maximum connectable indoor units*1, Capacity, Input power, EER, COP, SEER, SCOP, ηc, ηh, Air flow rate, Sound pressure level*2/ Power level, Max. External static pressure, Compressor motor output, Heat exchanger fin, Net Dimensions, Weight, Refrigerant, Connection pipe diameter, Operating Range).

Note: Specifications are based on the following conditions. Cooling: Indoor temperature of 27°CDB/19°CWB, and outdoor temperature of 35°CDB/24°CWB. Heating: Indoor temperature of 20°CDB/15°CWB, and outdoor temperature of 7°CDB/6°CWB. Pipe length: 7.5 m; Height difference between outdoor unit and indoor unit: 0 m.

When cooling operation is conducted at an outdoor air temperature below -5°C, the outdoor unit must be installed in a position that is higher than or equal to that of the indoor units. * These specifications are determined by ducted combination. * Multiple outdoor units are not certified by Eurovent.

*1: Minimum connectable indoor unit number is 2. *2: The noise level is the value measured in an anechoic room. When measured in an actual installation, the measured value is typically larger than the indicated value due to ambient noise and reflections.

*3: If the capacity range of the connectable indoor units is between 25% and 49.9%, do not open the three-way valve except for the unit to be operated. In addition, do not connect the power line.



Heat Pump
Modular type

VRF **V-IV**

System configuration example

- Suitable for air conditioning midsize and large buildings. Connecting each outdoor unit makes it possible to create a high-capacity system.
- Multiple indoor units are connected with separation tubes and headers.

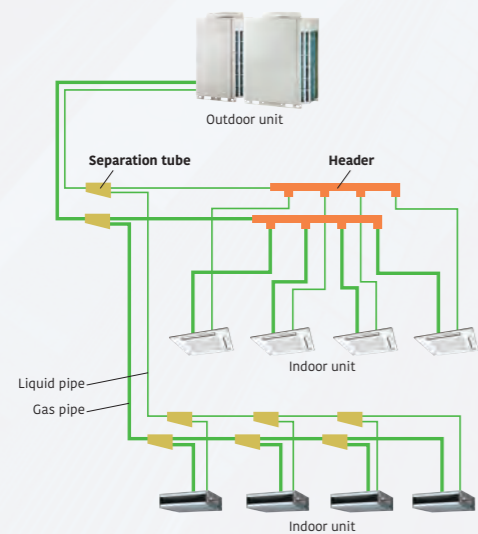

New intelligent refrigerant control

Fujitsu General is proposing outdoor units equipped with refrigerant control function. The refrigerant control operates with subtle control corresponding to the heat load of the room and offers a more comfortable environment. The refrigerant control can also provide increased energy savings.

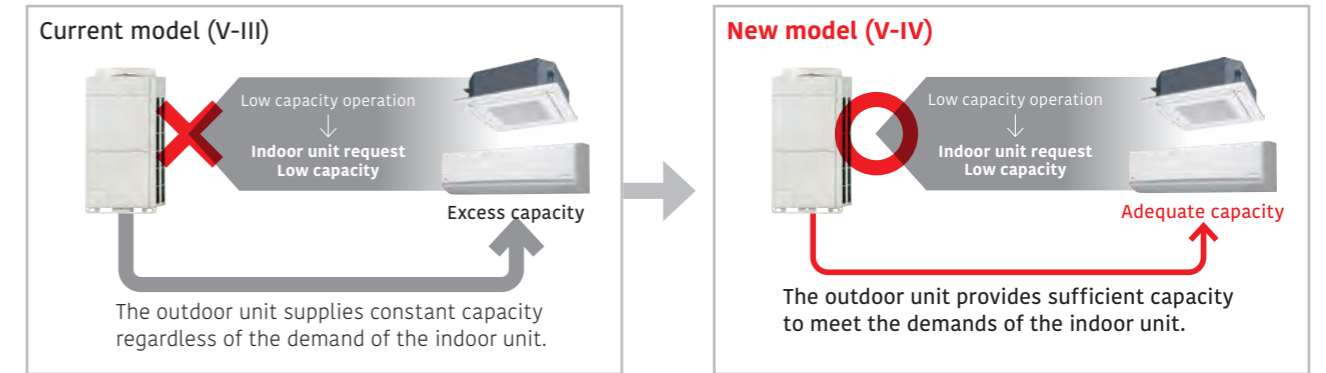

* The improvements due to the control and the actual sine wave vary depending on the combination of the indoor unit and system operating conditions.

Efficiency in actual operating conditions

The use of our proprietary heat exchanger structure and high-efficiency DC twin-rotary compressors achieves the class-leading coefficient of performance (COP) in every combination.

Space saving combination

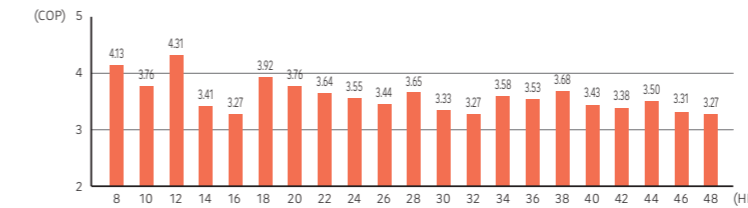

* These specifications are determined by Cassette combination.

Energy efficiency combination

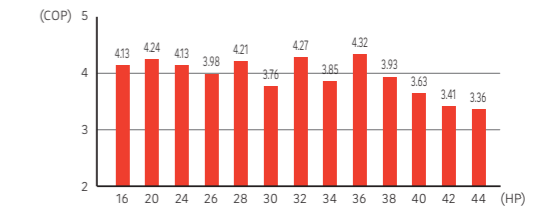

* Multiple outdoor units are not certified by Eurovent.

The energy-saving technology that boosted operation efficiency

- Powerful large propeller fan**
The fan uses CFD* technology to achieve both high performance and low noise operation. *CFD: Computational Fluid Dynamics
- 3-phase DC fan motor**
The use of a DC fan motor with sophisticated driver control improves energy efficiency substantially. In addition, low noise is realized by the DC fan motor.
- Sine-wave DC inverter control**
High-efficiency is realized by the adoption of reduced switching loss IPM.
- 4-face heat exchanger**
The 4-face heat exchanger increases the effective surface area and significantly improves heat-exchanging efficiency.
- Subcooling heat exchanger**
High heat exchange efficiency is achieved by using an internal projection-shape double-pipe construction.
- High-efficient, large-capacity DC twin-rotary compressor**
Large-capacity high-efficient DC twin-rotary compressor with excellent intermediate capability.
- Front intake port (Corner cut air inlet structure)**
In multiple outdoor unit installations, the unique front intake design improves airflow into the heat exchanger.

Outdoor units lineup - Combinations other than those listed below are not recommended.

Space saving combination

22.4 kW (8 HP) AJY072LALDH UNIT: AJY072LALDH	28.0 kW (10 HP) AJY090LALDH UNIT: AJY090LALDH	33.5 kW (12 HP) AJY108LALDH UNIT: AJY108LALDH	40.0 kW (14 HP) AJY126LALDH UNIT: AJY126LALDH	45.0 kW (16 HP) AJY144LALDH UNIT: AJY144LALDH
50.4 kW (18 HP) AJY162LALDH UNIT: AJY090/072LALDH	56.0 kW (20 HP) AJY180LALDH UNIT: AJY090/090LALDH	62.4 kW (22 HP) AJY198LALDH UNIT: AJY126/072LALDH	68.0 kW (24 HP) AJY216LALDH UNIT: AJY126/090LALDH	73.0 kW (26 HP) AJY234LALDH UNIT: AJY144/090LALDH
78.5 kW (28 HP) AJY252LALDH UNIT: AJY144/108LALDH	85.0 kW (30 HP) AJY270LALDH UNIT: AJY144/126LALDH	90.0 kW (32 HP) AJY288LALDH UNIT: AJY144/144LALDH	95.4 kW (34 HP) AJY306LALDH UNIT: AJY144/090/072LALDH	101.0 kW (36 HP) AJY324LALDH UNIT: AJY144/090/090LALDH
106.5 kW (38 HP) AJY342LALDH UNIT: AJY144/108/090LALDH	113.0 kW (40 HP) AJY360LALDH UNIT: AJY144/126/090LALDH	118.0 kW (42 HP) AJY378LALDH UNIT: AJY144/144/090LALDH	123.5 kW (44 HP) AJY396LALDH UNIT: AJY144/144/108LALDH	130.0 kW (46 HP) AJY414LALDH UNIT: AJY144/144/126LALDH
135.0 kW (48 HP) AJY432LALDH UNIT: AJY144/144/144LALDH				

Energy efficiency combination

44.8 kW (16 HP) AJY144LALDHH UNIT: AJY072/072LALDH	55.9 kW (20 HP) AJY180LALDHH UNIT: AJY108/072LALDH	67.2 kW (24 HP) AJY216LALDHH UNIT: AJY072/072/072LALDH	72.8 kW (26 HP) AJY234LALDHH UNIT: AJY090/072/072LALDH	78.3 kW (28 HP) AJY252LALDHH UNIT: AJY108/072/072LALDH
84.8 kW (30 HP) AJY270LALDHH UNIT: AJY126/072/072LALDH	89.4 kW (32 HP) AJY288LALDHH UNIT: AJY108/108/072LALDH	95.9 kW (34 HP) AJY306LALDHH UNIT: AJY126/108/072LALDH	100.5 kW (36 HP) AJY324LALDHH UNIT: AJY108/108/108LALDH	107.0 kW (38 HP) AJY342LALDHH UNIT: AJY126/108/108LALDH
113.5 kW (40 HP) AJY360LALDHH UNIT: AJY126/126/108LALDH	120.0 kW (42 HP) AJY378LALDHH UNIT: AJY126/126/126LALDH	125.0 kW (44 HP) AJY396LALDHH UNIT: AJY144/126/126LALDH		

8, 10 HP: AJY072LALDH / AJY090LALDH
12, 14, 16 HP: AJY108LALDH / AJY126LALDH / AJY144LALDH



8, 10 HP

12, 14, 16 HP

Dimensions

(Unit: mm)

8, 10 HP

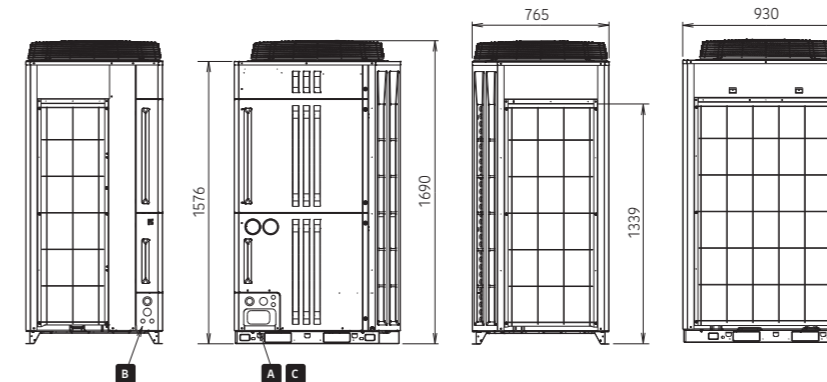
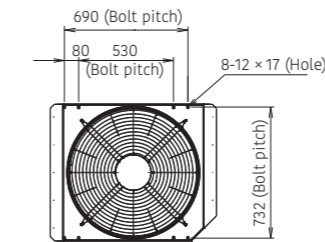

12, 14, 16 HP

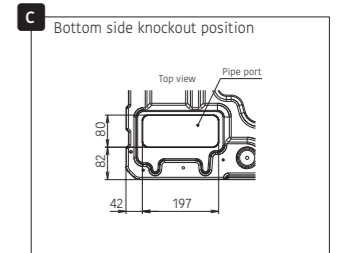
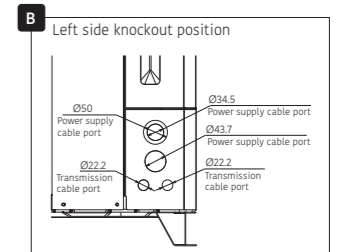
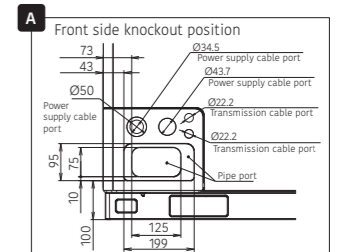
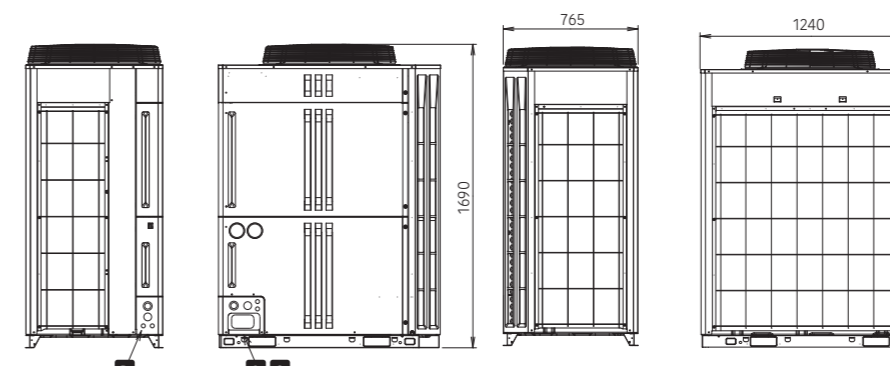
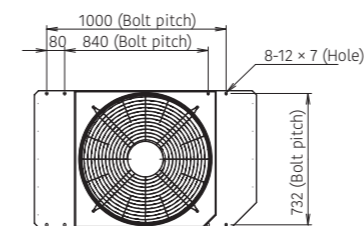

Outdoor unit specifications

Space saving combination

Table with 22 columns for capacity range (8-48 HP) and rows for Model name, Unit 1-3, Maximum connectable indoor units*1, Connectable capacity range of indoor units, Power source, Capacity, Input power, EER, COP, SEER, SCOP, ηc, ηh, Air flow rate, Sound pressure level*2/Power level, Max. External static pressure, Compressor motor output, Heat exchanger fin, Net Dimensions, Weight, Refrigerant, Connection pipe diameter, and Operating Range.

Energy Efficiency Combination

Table with 12 columns for capacity range (16-44 HP) and rows for Model name, Unit 1-3, Maximum connectable indoor units*1, Connectable capacity range of indoor units, Power source, Capacity, Input power, EER, COP, SEER, SCOP, ηc, ηh, Air flow rate, Sound pressure level*2/Power level, Max. External static pressure, Compressor motor output, Heat exchanger fin, Net Dimensions, Weight, Refrigerant, Connection pipe diameter, and Operating Range.

Note: Specifications are subject to the following conditions: Cooling: indoor temperature of 27°CDB/19°CWB, and outdoor temperature of 35°CDB/24°CWB. Heating: indoor temperature of 20°CDB/(15°CWB), and outdoor temperature of 7°CDB/6°CWB. Pipe length: 7.5 m; Height difference between outdoor unit and indoor unit: 0 m.

When cooling operation is conducted at an outdoor air temperature below -5°C, the outdoor unit must be installed in a position that is higher than or equal to that of the indoor units. *These specifications are determined by ducted combination. *Multiple outdoor units are not certified by Eurovent.

*1 Minimum connectable indoor unit number is 2. However, the ARXC72 and ARXC90 can be used with a signal connection. *2 The noise level is the value measured in an anechoic room.

When measured in an actual installation, the measured value is typically larger than the indicated value due to ambient noise and reflections. * These specifications are determined by ducted combination.

VRF INDOOR UNITS

17 types and 95 models available to meet the requirements of any building design.







Indoor units for the VRF Systems are compact, highly efficient, quiet, and user-friendly. Fujitsu General offers a variety of types and capacities for its indoor units that are easy to install and maintain. In addition, a variety of optional parts are available to provide an even more desirable air conditioning experience to users.

- V-058 VRF Indoor Unit Lineup for J-VS
- V-060 Compact Cassette Grid type
- V-062 Low Static Pressure Duct Slim Duct
- V-064 Wall-mounted type

- V-066 VRF Indoor Unit Lineup for J-IVS, J-IV, J-IVL, VR-IV, V-IV
- V-068 Compact Cassette Grid type
- V-070 Cassette Slim type Circular Flow
- V-072 Cassette Large type Circular Flow
- V-074 Cassette One-way Flow type
- V-076 3D Flow Cassette
- V-078 Low Static Pressure Duct Mini Duct
- V-080 Low Static Pressure Duct Slim Duct/Slim Concealed Floor
- V-082 Low Static Pressure Duct
- V-084 Medium Static Pressure Duct
- V-086 High Static Pressure Duct
- V-088 Compact Floor
- V-090 Floor/Ceiling
- V-092 Ceiling
- V-094 Wall-mounted (EEV Internal/external)



VRF Indoor Unit Lineup for J-VS

Capacity range (kW)				1.1	1.7	2.2	2.8	3.6	4.0	4.5	5.6	7.1
Class				4	5	7	9	12	14	14	18	24
Cassette	Compact type	Compact Grid type/Standard type		AUXB004HLAH	AUXB005HLAH	AUXB007HLAH	AUXB009HLAH	AUXB012HLAH		AUXB014HLAH	AUXB018HLAH	
		High Efficiency*1					AUXN009HLAH	AUXN012HLAH		AUXN014HLAH		
Duct	Low Static Pressure Duct	Slim Duct (With drain pump)	 004 - 014 018 024	ARXD004HLAH	ARXD005HLAH	ARXD007HLAH	ARXD009HLAH	ARXD012HLAH		ARXD014HLAH	ARXD018HLAH	ARXD024HLAH
		High Efficiency*1	 009 - 014				ARXP009HLAH	ARXP012HLAH		ARXP014HLAH		
Wall-mounted type	Wall-mounted type	Wall-mounted type	 004 - 014	ASYA004HCAH	ASYA005HCAH	ASYA007HCAH	ASYA009HCAH	ASYA012HCAH	ASYA014HCAH			
		Wall-mounted type (EEV external)	 004 - 014	ASYE004HCAH	ASYE005HCAH	ASYE007HCAH	ASYE009HCAH	ASYE012HCAH	ASYE014HCAH			
				This model requires the EV kit to be connected.				This model requires the EV kit to be connected.				

*1: Production by order
 Specifications and design are subject to change without notice.
 *Products other than ducts can be connected to J-IV, J-IVS, J-IVL, V-IV, VR-IV

Compact Cassette

Grid type



Compact and stylish panel

The compact and stylish panel fits nicely into a grid type ceiling. The linear design is a perfect fit into a grid of 620 mm x 620 mm in the ceiling.

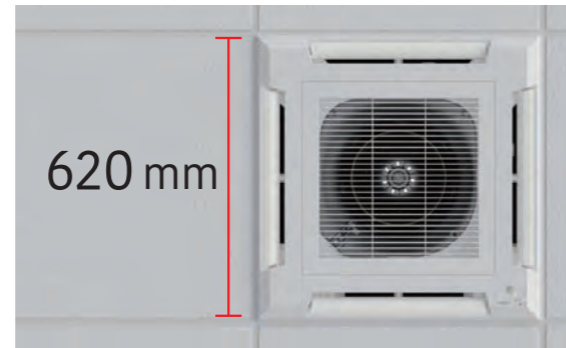

Easy maintenance

You can access the unit for maintenance just by removing a ceiling panel right next to the grille. As no inspection hole needs to be cut through the ceiling, no additional construction cost is incurred.



The air inlet grille can be installed to open in any direction for easy maintenance.



Flexible installation

The unit fits nicely into the decor of a grid type ceiling and can be installed near a lighting or a ventilation opening.



High ceiling mode

The cassette can be installed up to a height of 3.0 m. (012/014/018).

Model code	Maximum height from floor to ceiling (m)	
	Standard mode	High ceiling mode
004	2.7	-
005	2.7	-
007	2.7	-
009	2.7	-
012	2.7	3.0
014	2.7	3.0
018	2.7	3.0

Model: AUXB004HLAH / AUXB005HLAH / AUXB007HLAH / AUXB009HLAH / AUXB012HLAH / AUXB014HLAH / AUXB018HLAH / AUXN009HLAH / AUXN012HLAH / AUXN014HLAH * Production by order



Specifications

Model name		AUXB004HLAH	AUXB005HLAH	AUXB007HLAH	AUXB009HLAH	AUXB012HLAH	AUXB014HLAH	AUXB018HLAH	AUXN009HLAH	AUXN012HLAH	AUXN014HLAH
Power source		Single phase, 220-240V, 50Hz						Single phase, 220-240V, 50Hz			
Capacity	Cooling	1.1	1.7	2.2	2.8	3.6	4.5	5.6	2.8	3.6	4.5
	Heating	1.3	1.9	2.8	3.2	4.1	5.0	6.3	3.2	4.1	5.0
Input power		21	21	23	24	27	33	50	41	71	81
Airflow rate (Cooling / Heating)*	High	530	530	540	550	600	680	820	750	970	1,030
	Med-High	490 / 480	490 / 480	500	520	560	620	660	550	600	680
	Med	450 / 430	450 / 430	460	480	520	560	590	480	520	560
	Med-Low	420 / 380	420 / 380	420	440	480	500	520	440	480	500
	Low	390 / 340	390 / 340	390	400	430	440	460	400	430	440
	Quiet	350 / 300	350 / 300	350	350	390	390	400	350	390	390
Sound pressure level (Cooling / Heating)*	High	34	34	34	35	37	39	45	42	49	50
	Med-High	32 / 31	32 / 31	32	33	34	37	39	35	37	39
	Med	30 / 29	30 / 29	30	31	33	34	36	31	33	34
	Med-Low	28 / 26	28 / 26	28	29	31	32	33	29	31	32
	Low	27 / 24	27 / 24	27	27	29	30	30	27	29	30
	Quiet	25 / 21	25 / 21	25	25	27	27	27	25	27	27
Net Dimensions (H x W x D)		mm 245 x 570 x 570						mm 245 x 570 x 570			
Weight		14.5	14.5	15	15	15.5	15.5	17	15	15.5	15.5
Connection pipe diameter	Liquid (Flare)	6.35	6.35	6.35	6.35	6.35	6.35	6.35	6.35	6.35	6.35
	Gas (Flare)	9.52	9.52	9.52	9.52	12.70	12.70	12.70	9.52	12.70	12.70
Drain Hose Diameter (I.D./O.D.)		25 / 32	25 / 32	25 / 32	25 / 32	25 / 32	25 / 32	25 / 32	25 / 32	25 / 32	25 / 32
Cassette Grille	Model name	UTG-UFYH-W						UTG-UFYH-W			
	Net Dimensions (H x W x D)	mm 49 x 620 x 620						mm 49 x 620 x 620			
	Weight	2.3	2.3	2.3	2.3	2.3	2.3	2.3	2.3	2.3	2.3

Note: Specifications are subject to the following conditions:
 Cooling: Indoor temperature of 27°CDB/19°CWB, and outdoor temperature of 35°CDB/24°CWB.
 Heating: Indoor temperature of 20°CDB/(15°CWB), and outdoor temperature of 7°CDB/6°CWB.
 Pipe length: 7.5 m; Height difference between outdoor unit and indoor unit: 0 m. Voltage: 230 [V]
 *The value is the same for cooling and heating if there is one value.

Optional parts

*For more details, please refer to the chapter "Optional parts".

Wireless remote controller:	UTY-LNVY	WLAN adapter:	UTY-TFSXZ1, UTY-TFSXJ3,
Fresh Air Intake Kit:	UTZ-VXAA		FG-AC-WIF1Z1
Insulation kit for high humidity:	UTZ-KXGC	Gas sensor kit:	UTY-SGZY
Silver Ion Filter:	UTD-HFAA	Expansion kit:	UTZ-JXXA
Remote sensor kit:	UTY-XSZXZ1	Air Outlet Shutter Plate:	UTR-YDZB
Cassette Grille:	UTG-UFYH-W		

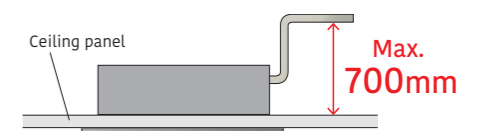

Dimensions

(Unit: mm)

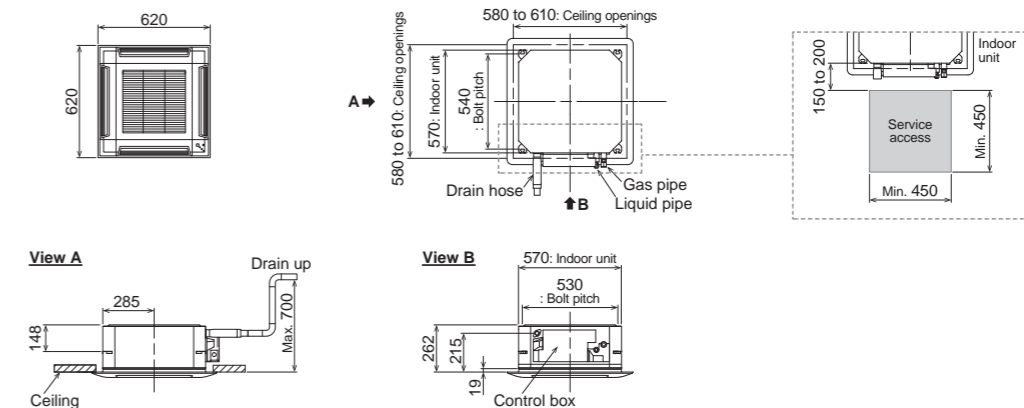

Low Static Pressure Duct Slim Duct



Slim design

Slim design allows for installation in a tight ceiling space.

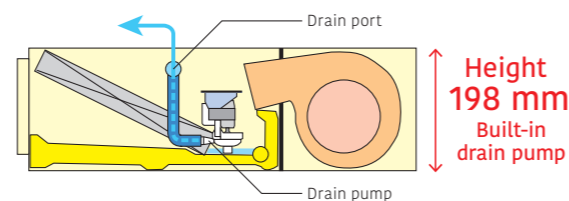

Air intake

Air intake direction can be selected to match the installation site.

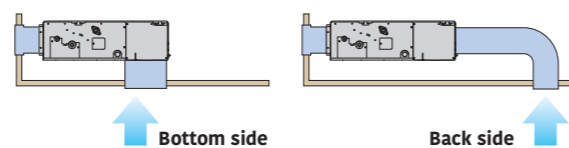

Wide range of static pressures

The use of a DC fan motor makes it possible to adjust the static pressure between 0 and 90 Pa. The static pressure range can be changed by a remote controller.



Static pressure range
0 to 90 Pa

* 024 model static pressure range is 0 to 50 Pa.

Auto louver grille kit (option)

The optional clean-looking flat Auto louver blends into any interior and provides a comfortable airflow.



Filter (Accessory)

ARXD004-018

ARXD024

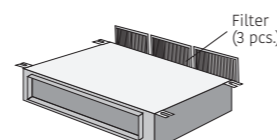
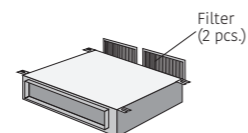

Model: ARXD004HLAH / ARXD005HLAH / ARXD007HLAH / ARXD009HLAH
ARXD012HLAH / ARXD014HLAH / ARXD018HLAH / ARXD024HLAH
ARXP009HLAH / ARXP012HLAH / ARXP014HLAH * Production by order



ARXD004/005/007/009/012/014HLAH
ARXP009/012/014HLAH



ARXK018HLAH

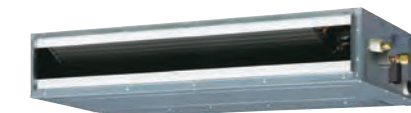

ARXK024HLAH

Specifications

Model name	ARXD004HLAH	ARXD005HLAH	ARXD007HLAH	ARXD009HLAH	ARXD012HLAH	ARXD014HLAH	ARXD018HLAH	ARXD024HLAH	ARXP009HLAH	ARXP012HLAH	ARXP014HLAH
Power source	Single phase, 220-240V, 50Hz						Single phase, 220-240V, 50Hz				
Capacity	Cooling	1.1	1.7	2.2	2.8	3.6	4.5	5.6	7.1	2.8	3.6
	Heating	1.3	1.9	2.8	3.2	4.0	5.0	6.3	8.0	3.2	4.0
Input power	W	38	38	41	47	48	84	76	107	77	128
Airflow rate	High	530	530	550	600	580	790	930	1,250	770	940
	Med-High	480	480	520	550	550	720	880	1,180	630	810
	Med	440	440	480	500	520	640	780	1,060	530	660
	Med-Low	410	410	450	460	480	560	670	930	480	580
	Low	370	370	400	400	430	470	580	810	430	490
Quiet	320	320	360	360	350	370	510	640	380	390	
Static pressure range	Pa	0 to 90	0 to 90	0 to 90	0 to 90	0 to 90	0 to 90	0 to 50	0 to 25	0 to 25	0 to 25
Standard static pressure		25	25	25	25	25	25	25	25	25	25
Sound pressure level	High	26	26	28	29	30	34	34	35	36	40
	Med-High	26	26	26	27	28	32	31	32	32	38
	Med	25	25	25	25	27	30	29	30	28	33
	Med-Low	24	24	24	24	26	28	27	27	27	31
	Low	22	22	22	22	24	25	25	24	25	27
Quiet	21	21	21	21	22	22	23	21	23	24	
Net Dimensions (H × W × D)	mm	198 × 700 × 620						198 × 900 × 620	198 × 1,100 × 620	198 × 700 × 620	
Weight	kg	16	16	16.5	16.5	17	17	21	25	16.5	17
Connection pipe diameter	Liquid (Flare)	6.35	6.35	6.35	6.35	6.35	6.35	6.35	9.52	6.35	6.35
	Gas (Flare)	9.52	9.52	9.52	9.52	12.70	12.70	12.70	15.88	9.52	12.70
Drain Hose Diameter (I.D./O.D.)		25 / 32	25 / 32	25 / 32	25 / 32	25 / 32	25 / 32	25 / 32	25 / 32	25 / 32	25 / 32

Note: Specifications are subject to the following conditions:
Cooling: Indoor temperature of 27°CDB/19°CWB, and outdoor temperature of 35°CDB/24°CWB.
Heating: Indoor temperature of 20°CDB/(15°CWB), and outdoor temperature of 7°CDB/6°CWB.
Pipe length: 7.5 m; Height difference between outdoor unit and indoor unit: 0 m. Voltage: 230 [V]
*1: This value is under cooling operation.

Optional parts

*For more details, please refer to the chapter "Optional parts".

Wireless remote controller: UTY-LNVY*	Auto Louver Grille Kit: UTD-GXTA-W (004-014)
Remote sensor unit: UTY-XSZXZ1	UTD-GXTB-W (018)
IR receiver unit: UTY-TRHX	UTD-GXTC-W (024)
WLAN adapter: UTY-TFSXJ3	Silver Ion Filter: UTD-HFTA (004-014)
UTY-TFSXZ1	UTD-HFTB (018)
FG-AC-WIF1Z1	UTD-HFTC (024)
UTZ-JXXA	Gas sensor kit: UTY-SGZY

*IR receiver unit (UTY-TRHX) is required.

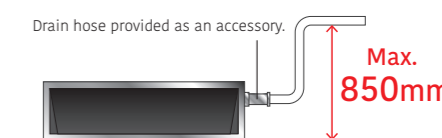

Dimensions

(Unit: mm)

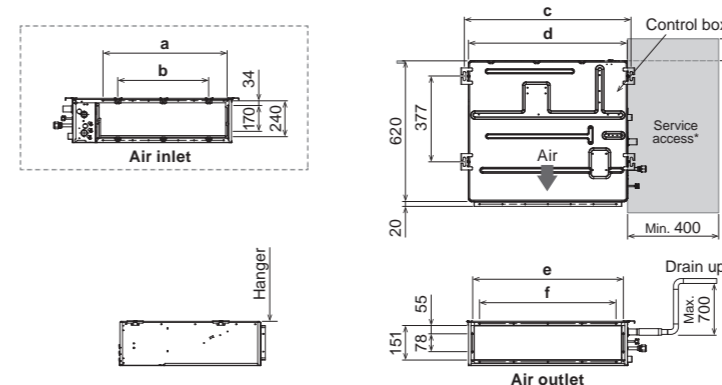

	ARXD 004-014HLAH	ARXD018HLAH	ARXD024HLAH
a	574	774	974
b	P200x2=400	P200x3=600	P200x4=800
c	734	934	1,134
d	700	900	1,100
e	650	850	1,050
f	P100x6=600	P100x8=800	P100x10=1,000

*The design of the service access depends on the installation method. Refer to the installation manual for more information.

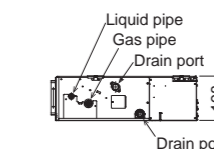

Wall-mounted type



Highly-efficiency, compact design

The 004-014 models share the same design. The high-density and large heat exchanger achieves a highly-efficiency and compact design. The compact body blends in well with conference rooms and offices, providing comfortable air conditioning.

High-density heat exchanger



Slim tube design: 5 mm
Greater heat-exchanging capacity is achieved through the use of a high-density heat exchanger and a sub-heat exchanger.

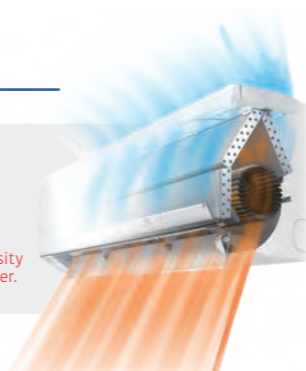

More comfortable airflow

The unique power diffuser provides comfortable air conditioning.

Heating

The vertical airflow provides powerful floor-level heating.



Cooling

The left/right airflow avoids blowing cool air directly at the occupants in a room.



Quiet operation & 6-Step fan speed control

The airflow pattern achieves significant noise reduction. Multistep airflow adjustment to suit the environment

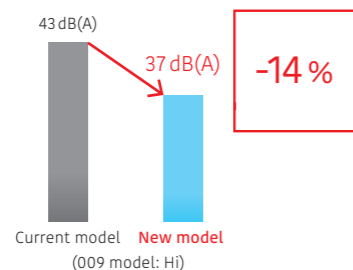

- 6-Step Speed
- High
- Med-High
- Med
- Med-Low
- Low
- Quiet

* Remote controller is compatible with the following:
UTY-RVRY / UTY-LNVY / UTY-RNRYZ5 / UTY-RLRY / UTY-RSRY / UTY-RHRY / UTY-DCGYZ2 / UTY-ALGXZ1 / UTY-APGXZ1

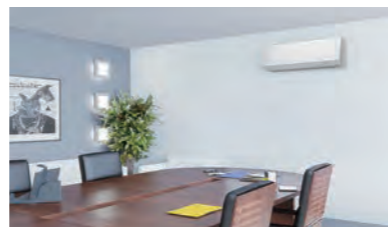

The Occupancy sensor contributes to further energy savings.

Energy saving operation starts automatically by detecting the motion of a person. Two modes of save operation mode and stop mode can be selected.

* If you want to use the Occupancy sensor control function, you need an setting device that can set the Occupancy sensor control function. For example: Wired RC (Touch panel).

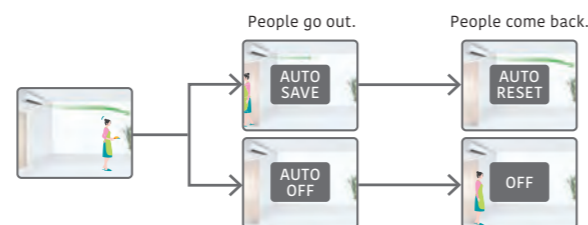

Model: ASYA004HCAH / ASYA005HCAH / ASYA007HCAH / ASYA009HCAH / ASYA012HCAH / ASYA014HCAH
[external EEV]
ASYE004HCAH / ASYE005HCAH / ASYE007HCAH / ASYE009HCAH / ASYE012HCAH / ASYE014HCAH



Specifications

Model name	AS YA004HCAH	AS YA005HCAH	AS YA007HCAH	AS YA009HCAH	AS YA012HCAH	AS YA014HCAH	AS YE004HCAH	AS YE005HCAH	AS YE007HCAH	AS YE009HCAH	AS YE012HCAH	AS YE014HCAH	
Power source	Single phase, 220-240V, 50Hz						Single phase, 220-240V, 50Hz						
Capacity	Cooling	1.1	1.7	2.2	2.8	3.6	4.0	1.1	1.7	2.2	2.8	3.6	4.0
	Heating	1.3	1.9	2.8	3.2	4.0	4.5	1.3	1.9	2.8	3.2	4.0	4.5
Input power	W	12	12	16	19	25	35	12	12	16	19	25	35
Airflow rate	High	450	450	550	590	660	770	450	450	550	590	660	770
	Med-High	430	430	490	550	590	710	430	430	490	550	590	710
	Med	400	400	450	490	550	650	400	400	450	490	550	650
	Med-Low	380	380	390	420	510	590	380	380	390	420	510	590
	Low	360	360	360	360	450	530	360	360	360	360	450	530
Sound pressure level	Quiet	310	310	320	320	320	320	310	310	320	320	320	320
	High	31	31	34	37	40	44	31	31	34	37	40	44
	Med-High	30	30	32	34	37	42	30	30	32	34	37	42
	Med	28	28	30	32	34	40	28	28	30	32	34	40
	Med-Low	27	27	28	29	33	37	27	27	28	29	33	37
Low	26	26	26	26	30	34	26	26	26	26	30	34	
Quiet	22	22	22	22	22	22	22	22	22	22	22	22	
Net Dimensions (H x W x D)	mm	268 x 840 x 203						268 x 840 x 203					
Weight	kg	8	8	8.5	8.5	8.5	8.5	8	8	8.5	8.5	8.5	8.5
Connection pipe diameter	Liquid (Flare)	6.35	6.35	6.35	6.35	6.35	6.35	6.35	6.35	6.35	6.35	6.35	6.35
	Gas (Flare)	9.52	9.52	9.52	9.52	12.70	12.70	9.52	9.52	9.52	9.52	12.70	12.70
Drain Hose Diameter (I.D./O.D.)		13.8/15.8 to16.7						13.8/15.8 to16.7					
EV kit (optional)		-	-	-	-	-	-	UTR-EV09XC			UTR-EV14XC		

Note: Specifications are subject to the following conditions:
Cooling: Indoor temperature of 27°CDB/19°CWB, and outdoor temperature of 35°CDB/24°CWB.
Heating: Indoor temperature of 20°CDB/(15°CWB), and outdoor temperature of 7°CDB/6°CWB.
Pipe length: 7.5 m; Height difference between outdoor unit and indoor unit: 0 m. Voltage: 230 [V]
When connecting ASY*004G**H, ASY*007G**H, ASY*009G**H to an outdoor unit other than the outdoor unit of the J-IVL Series, the gas pipe diameter should be Ø12.70 mm.

Optional parts

Wireless remote controller: UTY-LNVY
Silver Ion Filter: UTR-FA16-5

Expansion kit: UTY-JXXA
Remote sensor kit: UTY-XSZXZ1

WLAN adapter: UTY-TFSXZ1, UTY-TFSXJ3, FG-AC-WIF1Z1
Gas sensor kit: UTY-SGZY







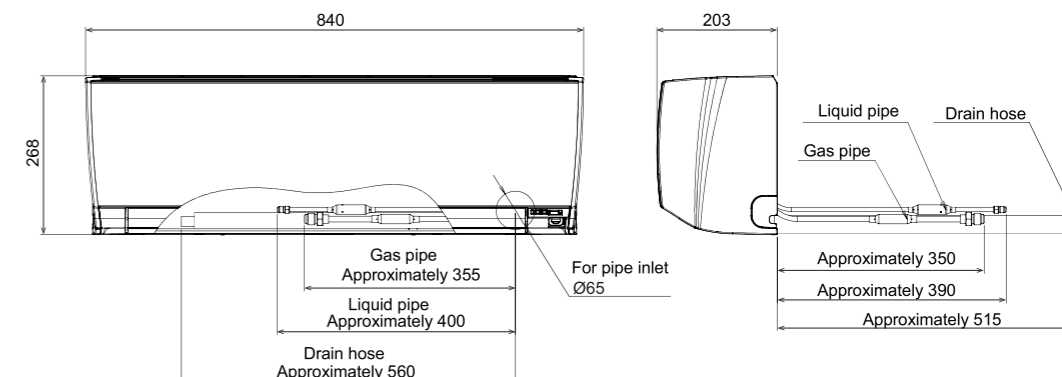









*For more details, please refer to the chapter "Optional parts".

Dimensions

(Unit: mm)



VRF Indoor Unit Lineup for J-IVS J-IV J-IVL VR-IV V-IV

Capacity range (kW)			1.1	2.2	2.8	3.6	4.0	4.5	5.6	7.1	9.0	10.0	11.2	12.5	14.0	18.0	22.4	25.0	28.0		
Class			4	7	9	12	14	14	18	24	30	34	36	45	54	60	72	90	96		
Cassette	Compact type	Compact Grid type/Standard type		AUXB 004 GLEH	AUXB 007 GLEH	AUXB 009 GLEH	AUXB 012 GLEH		AUXB 014 GLEH	AUXB 018 GLEH	AUXB 024 GLEH										
	Slim type	Circular Flow								AUXM 018 GLEH	AUXM 024 GLEH	AUXM 030 GLEH									
	Large type	Circular Flow								AUXK 018 GLEH	AUXK 024 GLEH	AUXK 030 GLEH	AUXK 034 GLEH	AUXK 036 GLEH	AUXK 045 GLEH	AUXK 054 GLEH					
	One-way Flow type	One-way Flow	 004 - 012 014 - 024	AUXV 004 GLEH	AUXV 007 GLEH	AUXV 009 GLEH	AUXV 012 GLEH		AUXV 014 GLEH	AUXV 018 GLEH	AUXV 024 GLEH										
	3D Flow type	3D Flow								AUXS 018 GLEH	AUXS 024 GLEH										
Duct	Low Static Pressure Duct	Mini Duct (With drain pump)	 004 - 014 018 024	ARXK 004 GLGH	ARXK 007 GLGH	ARXK 009 GLGH	ARXK 012 GLGH		ARXK 014 GLGH	ARXK 018 GLGH	ARXK 024 GLGH										
		Slim Duct (With drain pump)	 04/007 - 014 018 024	ARXD 04 GALH*2	ARXD 007 GLEH	ARXD 009 GLEH	ARXD 012 GLEH		ARXD 014 GLEH	ARXD 018 GLEH	ARXD 024 GLEH										
		High Efficiency*3								ARXP 018 GLFH		ARXP 030 GLFH									
	Medium static pressure duct	Normal									ARXA 024 GLEH	ARXA 030 GLEH		ARXA 036 GLEH	ARXA 045 GLEH						
	High Static Pressure Duct	Normal	 036/45 - 60 072 - 090 096												ARXC 036 GTEH	ARXC 045 GTEH		ARXC 060 GTEH*1	ARXC 072 GTEH*1	ARXC 090 GTEH*1	ARXC 096 GTEH*1
Floor	Floor (*Same as Ceiling models)					ABYA 012 GTEH		ABYA 014 GTEH	ABYA 018 GTEH	ABYA 024 GTEH											
	Slim Concealed Floor (*Same as Slim Duct models)	 04/007 - 014 018 024	ARXD 04 GALH*2	ARXD 007 GLEH	ARXD 009 GLEH	ARXD 012 GLEH		ARXD 014 GLEH	ARXD 018 GLEH	ARXD 024 GLEH											
	Compact Floor		AGYA 004 GCGH	AGYA 007 GCGH	AGYA 009 GCGH	AGYA 012 GCGH		AGYA 014 GCGH													
	Compact Floor (EEV external)		AGYE 004 GCEH	AGYE 007 GCEH	AGYE 009 GCEH	AGYE 012 GCEH		AGYE 014 GCEH													
			This model requires the EV kit to be connected.																		
Ceiling		 012 - 024 030 - 054				ABYA 012 GTEH		ABYA 014 GTEH	ABYA 018 GTEH	ABYA 024 GTEH	ABYA 030 GTEH		ABYA 036 GTEH	ABYA 045 GTEH	ABYA 054 GTEH						
Wall-mounted type	Wall-mounted type	 004 - 014 18 - 24 030 - 034	ASYA 004 GCGH	ASYA 007 GCGH	ASYA 009 GCGH	ASYA 012 GCGH		ASYA 014 GCGH		ASYA 018 GBCH	ASYA 024 GBCH	ASYA 030 GTEH	ASYA 034 GTEH								
	Wall-mounted type (EEV external)	 004 - 014	ASYE 004 GCEH	ASYE 007 GCEH	ASYE 009 GCEH	ASYE 012 GCEH		ASYE 014 GCEH													
			This model requires the EV kit to be connected.																		

*1: ARXC060/072/090/096G cannot be connected to J-IVS/J-IV Series.
 *2: ARXD04GALH cannot be connected to J-IVS/J-IV/J-IVL/VR-IV Series.
 *3: Production by order
 Specifications and design are subject to change without notice.

Compact Cassette

Grid type



Compact and stylish panel

The compact and stylish panel fits nicely into a grid type ceiling. The linear design is a perfect fit into a grid of 620 mm x 620 mm in the ceiling.

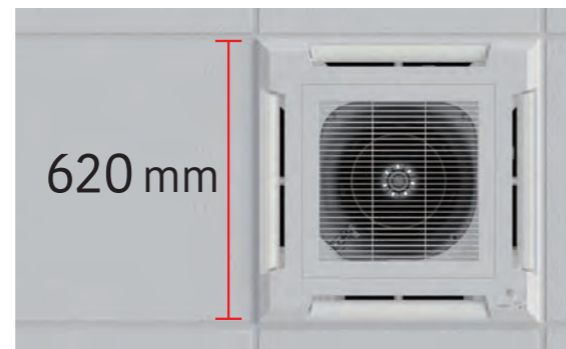

Easy maintenance

You can access the unit for maintenance just by removing a ceiling panel right next to the grille. As no inspection hole needs to be cut through the ceiling, no additional construction cost is incurred.



The air inlet grille can be installed to open in any direction for easy maintenance.



Flexible installation

The unit fits nicely into the decor of a grid type ceiling and can be installed near a lighting or a ventilation opening.



High ceiling mode

The cassette can be installed up to a height of 3.0 m. (012/014/018/024).

Model code	Maximum height from floor to ceiling (m)	
	Standard mode	High ceiling mode
004	2.7	-
007	2.7	-
009	2.7	-
012	2.7	3.0
014	2.7	3.0
018	2.7	3.0
024	2.7	3.0

**Model: AUXB004GLEH / AUXB007GLEH / AUXB009GLEH
AUXB012GLEH / AUXB014GLEH / AUXB018GLEH
AUXB024GLEH**



Specifications

Model name		AUXB004GLEH	AUXB007GLEH	AUXB009GLEH	AUXB012GLEH	AUXB014GLEH	AUXB018GLEH	AUXB024GLEH
Power source		Single phase, ~230 V, 50 Hz						
Capacity	Cooling	1.1	2.2	2.8	3.6	4.5	5.6	7.1
	Heating	1.3	2.8	3.2	4.1	5.0	6.3	8.0
Input power		23	25	25	29	35	36	84
Airflow rate	High	530/530	540	550	600	680	710	1,030
	Med-High	490/480	500	520	560	620	660	910
	Med	450/430	460	480	520	560	590	790
	Med-Low	420/380	420	440	480	500	520	680
	Low	390/340	390	400	430	440	460	560
	Quiet	350/300	350	350	390	390	400	450
Sound pressure level	High	34/34	34	35	37	38	41	50
	Med-High	32/31	32	33	34	37	39	46
	Med	30/29	30	31	33	34	36	43
	Med-Low	28/26	28	29	31	32	33	39
	Low	27/24	27	27	29	30	30	35
	Quiet	25/21	25	25	27	27	27	30
Net Dimensions (H x W x D)		mm 245 x 570 x 570	245 x 570 x 570	245 x 570 x 570	245 x 570 x 570	245 x 570 x 570	245 x 570 x 570	245 x 570 x 570
Weight		kg 14.5	15	15	15	15	17	17
Connection pipe diameter	Liquid (Flare)	6.35	6.35	6.35	6.35	6.35	6.35	9.52
	Gas (Flare)	9.52	9.52	9.52	12.70	12.70	12.70	15.88
Drain Hose Diameter (I.D./O.D.)		25/32						
Cassette Grille	Model name	UTG-UFYE-W/UTG-UFYC-W						
	Net Dimensions (H x W x D)	mm 49 x 620 x 620/50 x 700 x 700						
	Weight	kg 2.3/2.6						

Note: Specifications are subject to the following conditions:
Cooling: Indoor temperature of 27°CDB/19°CWB, and outdoor temperature of 35°CDB/24°CWB.
Heating: Indoor temperature of 20°CDB/(15°CWB), and outdoor temperature of 7°CDB/6°CWB.
Pipe length: 7.5 m; Height difference between outdoor unit and indoor unit: 0 m. Voltage: 230 [V]
*1: This value is under cooling operation.

Optional parts

*For more details, please refer to the chapter "Optional parts".

Air Outlet Shutter Plate:	UTR-YDZB	Cassette Grille:	UTG-UFYC-W, UTG-UFYE-W
Fresh Air Intake Kit:	UTZ-VXAA	External power supply unit:	UTZ-GXXA, UTZ-GXXC*
Insulation kit for high humidity:	UTZ-KXGC	WLAN adapter:	UTY-TFSXZ1, UTY-TFSXJ3,
Silver Ion Filter:	UTD-HFAA		FG-AC-WIF1Z1
Remote sensor kit:	UTY-XSZXZ1		

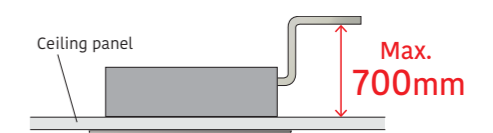

Dimensions

(Unit: mm)

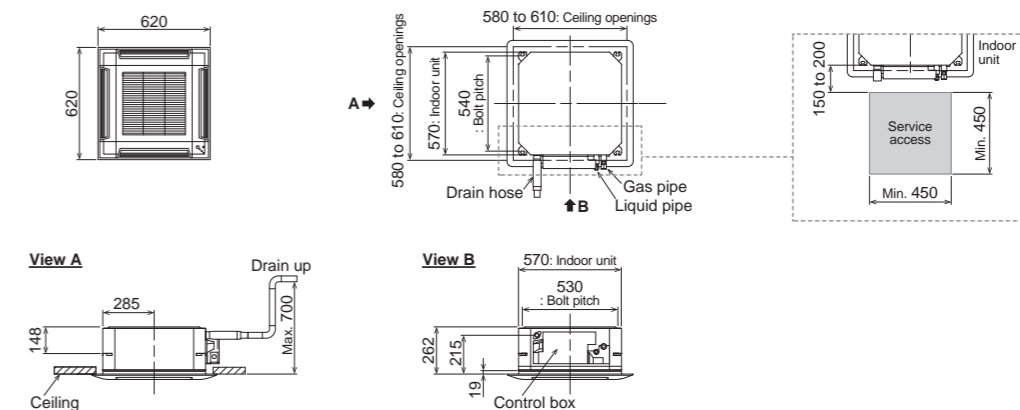

Cassette Slim type

Circular Flow



Unique circular flow design

This Cassette type air conditioner is equipped with a high performance DC fan motor, a turbo fan, and a louver to propel powerful airflows in all directions.

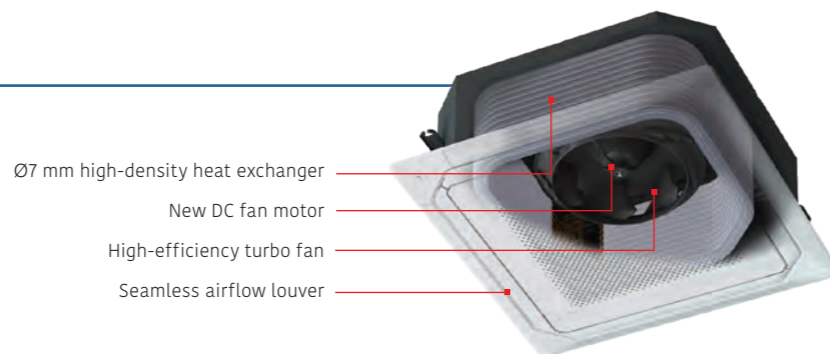

Uniform temperature air conditioning

Achieve a comfortable air conditioning spread to every corner of the room thanks to the circular flow and wide vertical airflow.

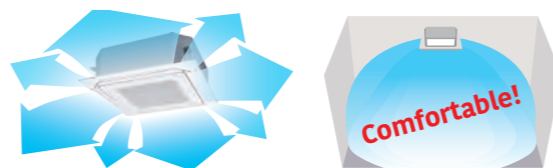

Individual louver control

Each louver can be set individually by the Touch panel wired remote controller so the user can enjoy the comfort of different directional airflows according to the room layout.

* UTY-RNRZY5 Wired remote controller with touch panel and UTY-DCGYZ3 Central remote controller only



Comfortable air conditioning by preventing direct blowing of cold air and by providing swinging air flow simultaneously.

Provides efficient air conditioning based on the room layout

The Human sensor contributes to further energy savings.

Energy saving operation starts automatically by detecting the motion of a person. Two modes of save operation mode and stop mode can be selected.

* UTY-RNRZY5 Wired remote controller with touch panel and UTY-DCGYZ3 Central remote controller only



Human sensor (Optional)

2 modes are available to choose from:

- Auto economy mode** The air conditioner switches to operate on reduced power when it detects that the room is unoccupied.
- Auto-off mode** The air conditioner stops operating when it detects that the room is unoccupied.

Model: AUXM018GLEH / AUXM024GLEH / AUXM030GLEH



Specifications

Model name		AUXM018GLEH	AUXM024GLEH	AUXM030GLEH
Power source		Single phase, ~230 V, 50 Hz		
Capacity	Cooling	5.6	7.1	9.0
	Heating	6.3	8.0	10.0
Input power		20	25	49
Airflow rate	High	1,050	1,120	1,470
	Med-High	930	1,050	1,160
	Med	900	930	1,070
	Med-Low	870	900	930
	Low	810	870	900
	Quiet	780	780	780
Sound pressure level	High	33	35	40
	Med-High	32	33	36
	Med	31	32	34
	Med-Low	30	31	32
	Low	29	30	31
	Quiet	28	28	28
Dimensions (H × W × D)		246 × 840 × 840		
Weight		24.0	24.5	24.5
Connection pipe diameter	Liquid (Flare)	6.35	9.52	9.52
	Gas (Flare)	12.70	15.88	15.88
Drain Hose Diameter (I.D./O.D.)		25/32		
Cassette Grille	Model name	UTG-UKYC-W/UTG-UKYA-B		
	Dimensions (H × W × D)	53 × 950 × 950		
	Weight	6.0		

Note: Specifications are subject to the following conditions:
 Cooling: Indoor temperature of 27°CDB/19°CWB, and outdoor temperature of 35°CDB/24°CWB.
 Heating: Indoor temperature of 20°CDB/(15°CWB), and outdoor temperature of 7°CDB/6°CWB.
 Pipe length: 7.5 m; Height difference between outdoor unit and indoor unit: 0 m. Voltage: 230 [V].
 When AUX*018GLEH is connected to an outdoor unit other than one of the J-IVL Series, the pipe diameter should be Ø9.52/Ø15.88 mm (Liquid/Gas).
 When connecting AUXK036GLEH, AUXK045GLEH, and AUXK054GLEH to an outdoor unit other than the outdoor unit of the J-IVL Series, the gas pipe diameter should be Ø19.05 mm.

Optional parts

*For more details, please refer to the chapter "Optional parts".

Human sensor Kit: UTY-SHZXC	Air Outlet Shutter Plate: UTR-YDZK	IR Receiver Unit: UTY-LBHXD
Wide Panel: UTG-AKXA-W	Insulation kit for high humidity: UTZ-KXRA	WLAN adapter: UTY-TFSXZ1, UTY-TFSXJ3, FG-AC-WIF1Z1
Panel Spacer: UTG-BKXA-W	Cassette Grille: UTG-UKYC-W, UTG-UKYA-B	Silver Ion Filter: UTD-HFRA
Fresh air intake kit: UTZ-VXRA	External power supply unit: UTZ-GXXA, UTZ-GXXC*	Remote sensor kit: UTY-XSZXZ1

Dimensions

(Unit: mm)

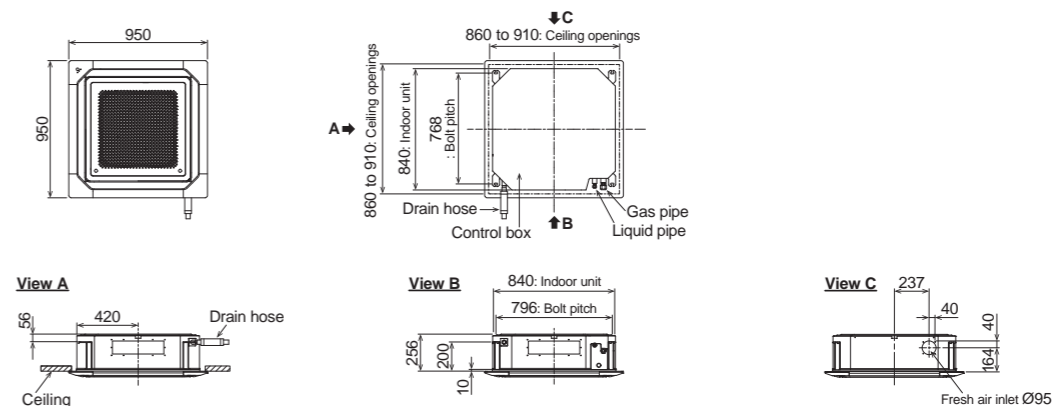

Cassette Large type

Circular Flow



Unique circular flow design

This Cassette type air conditioner is equipped with a high performance DC fan motor, a turbo fan, and a louver to propel powerful airflows in all directions.

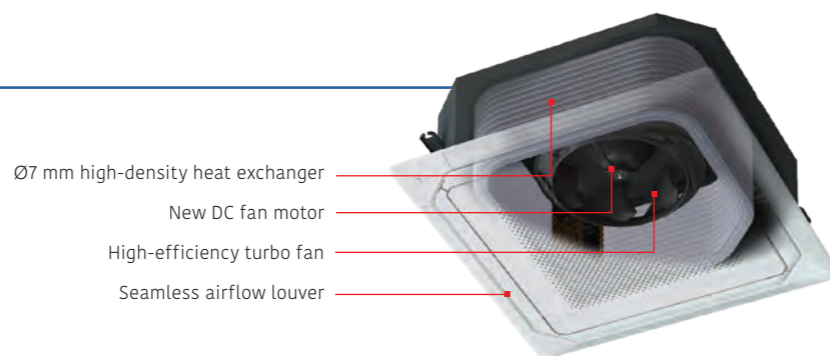

Uniform temperature air conditioning

Achieve a comfortable air conditioning spread to every corner of the room thanks to the circular flow and wide vertical airflow.

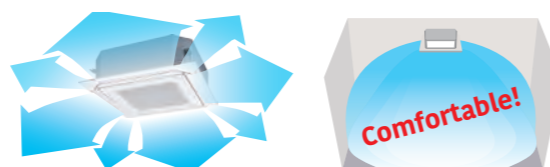

Individual louver control

Each louver can be set individually by the Touch panel wired remote controller so the user can enjoy the comfort of different directional airflows according to the room layout.

* UTY-RNRYZ5 Wired remote controller with touch panel and UTY-DCGYZ3 Central remote controller only



Comfortable air conditioning by preventing direct blowing of cold air and by providing swinging air flow simultaneously.

Provides efficient air conditioning based on the room layout

The Human sensor contributes to further energy savings.

Energy saving operation starts automatically by detecting the motion of a person. Two modes of save operation mode and stop mode can be selected.

* UTY-RNRYZ5 Wired remote controller with touch panel and UTY-DCGYZ3 Central remote controller only



Human sensor (Optional)

2 modes are available to choose from:

- Auto economy mode** The air conditioner switches to operate on reduced power when it detects that the room is unoccupied.
- Auto-off mode** The air conditioner stops operating when it detects that the room is unoccupied.

**Model: AUXK018GLEH / AUXK024GLEH / AUXK030GLEH
AUXK034GLEH / AUXK036GLEH / AUXK045GLEH
AUXK054GLEH**



Specifications

Model name	AUXK018GLEH	AUXK024GLEH	AUXK030GLEH	AUXK034GLEH	AUXK036GLEH	AUXK045GLEH	AUXK054GLEH
Power source	Single phase, ~230 V, 50 Hz						
Capacity	Cooling	5.6	7.1	9.0	10.0	11.2	14.0
	Heating	6.3	8.0	10.0	11.2	12.5	16.0
Input power	W	40	40	47	47	61	116
Airflow rate	High	1,420	1,420	1,440	1,440	1,620	2,040
	Med-High	1,360	1,360	1,400	1,400	1,500	1,800
	Med	1,300	1,300	1,340	1,340	1,400	1,590
	Med-Low	1,270	1,270	1,300	1,300	1,340	1,440
	Low	1,200	1,200	1,280	1,280	1,280	1,300
Sound pressure level	Quiet	1,150	1,150	1,150	1,150	1,150	1,150
	High	38	38	39	39	41	44
	Med-High	37	37	38	38	40	42
	Med	36	36	37	37	38	40
	Med-Low	35	35	36	36	37	38
Low	34	34	35	35	36	36	
Quiet	33	33	33	33	33	33	
Dimensions (H × W × D)	mm 288 × 840 × 840						
Weight	kg	26.5	26.5	29.5	29.5	29.5	29.5
Connection pipe diameter	Liquid (Flare)	6.35	9.52	9.52	9.52	9.52	9.52
	Gas (Flare)	12.70	15.88	15.88	15.88	15.88	15.88
Drain Hose Diameter (I.D./O.D.)	25/32						
Cassette Grille	Model name	UTG-UKYC-W/UTG-UKYA-B					
	Dimensions (H × W × D)	mm 53 × 950 × 950					
	Weight	kg 6.0					

Note: Specifications are subject to the following conditions:
Cooling: Indoor temperature of 27°CDB/19°CWB, and outdoor temperature of 35°CDB/24°CWB.
Heating: Indoor temperature of 20°CDB/(15°CWB), and outdoor temperature of 7°CDB/6°CWB.
Pipe length: 7.5 m; Height difference between outdoor unit and indoor unit: 0 m. Voltage: 230 [V].
When AUX*018GLEH is connected to an outdoor unit other than one of the J-IVL Series, the pipe diameter should be Ø9.52/Ø15.88 mm (Liquid/Gas).
When connecting AUXK036GLEH, AUXK045GLEH, and AUXK054GLEH to an outdoor unit other than the outdoor unit of the J-IVL Series, the gas pipe diameter should be Ø19.05 mm.

Optional parts

*For more details, please refer to the chapter "Optional parts".

Human sensor kit: UTY-SHZXC	Air Outlet Shutter Plate: UTR-YDZK	IR Receiver Unit: UTY-LBHXD
Wide Panel: UTG-AKXA-W	Insulation kit for high humidity: UTZ-KXRA	WLAN adapter: UTY-TFSXZ1, UTY-TFSXJ3, FG-AC-WIF1Z1
Panel Spacer: UTG-BKXA-W	Cassette Grille: UTG-UKYC-W, UTG-UKYA-B	Silver Ion Filter: UTD-HFRA
Fresh air intake kit: UTZ-VXRA	External power supply unit: UTZ-GXXA, UTZ-GXXC*	Remote sensor kit: UTY-XSZXZ1

Dimensions

(Unit: mm)

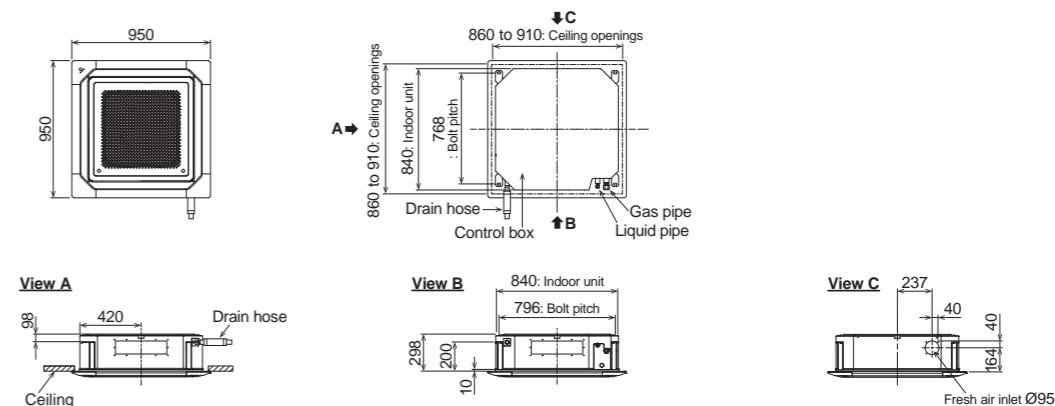

Cassette

One-way Flow type



Compact chassis size

The compact size allows easy installation in a variety of commercial facilities and environments.

- The height of the chassis is less than 200 mm for all models.
- All 4 to 12 kBTu models are less than 1,000 mm wide.
- The depth of the chassis is 570 mm, which fits nicely into a grid type ceiling.

Dimensions (Panel size) (Unit: mm)

	4	7	9	12	14	18	24
H		198 (43)				198 (43)	
W		785 (950)				1,190 (1,360)	
D		570 (620)				570 (620)	

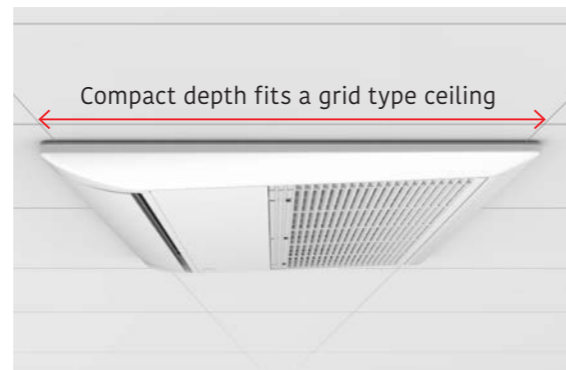

Wide airflow range

A large flap with a wide range of movements, equipped with louvers arranged triangularly, sends air into every corner of the room.

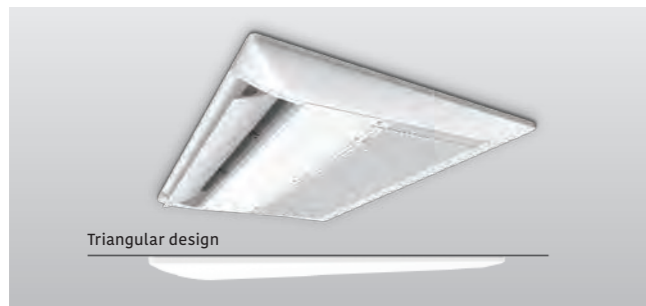

In cooling mode, the left/right airflow reaches every corner of the room without directly touching the human body to provide comfortable air conditioning.



In heating mode, warm air is directed downward toward the floor to warm the feet and lower body, while the head is kept relatively cool.

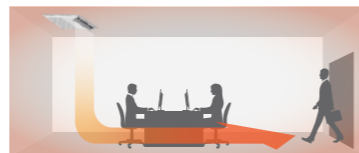

Note: This is a conceptual drawing. The performance of an air conditioner may vary depending on where it is installed, the size of the room, and its distance from the wall.

Quiet mode

The low operating noise makes the model ideal for use in hotel rooms.



Model: AUXV004GLEH / AUXV007GLEH / AUXV009GLEH
 AUXV012GLEH / AUXV014GLEH / AUXV018GLEH
 AUXV024GLEH



AUXV004/007/009/012GLEH



AUXV014/018/024GLEH

Specifications

Model name		AUXV004GLEH	AUXV007GLEH	AUXV009GLEH	AUXV012GLEH	AUXV014GLEH	AUXV018GLEH	AUXV024GLEH
Power source		Single phase, ~230 V, 50 Hz						
Capacity	Cooling	1.1	2.2	2.8	3.6	4.5	5.6	7.1
	Heating	1.3	2.8	3.2	4.0	5.0	6.3	8.0
Input power		30/30	42/42	42/42	60/60	38/38	56/56	99/99
Airflow rate*	High	460	550	550	670	720	890	1,150
	Med-High	440	440	440	520	660	840	1,020
	Med	420	420	420	480	630	770	940
	Med-Low	400	400	400	450	600	710	790
	Low	380	380	380	410	580	660	700
	Quiet	360	360	360	360	550	580	610
Sound pressure level*	High	38	42	42	45	37	44	49
	Med-High	37	37	37	41	36	43	47
	Med	36	36	36	39	35	40	45
	Med-Low	35	35	35	38	34	38	42
	Low	33	33	33	36	33	36	39
	Quiet	32	32	32	32	32	34	36
Net Dimensions (H × W × D)		mm 198 × 785 × 570	198 × 785 × 570	198 × 785 × 570	198 × 785 × 570	198 × 1,190 × 570	198 × 1,190 × 570	198 × 1,190 × 570
Weight		kg 18	19	19	19	26	26	27
Connection pipe diameter	Liquid (Flare)	6.35	6.35	6.35	6.35	6.35	6.35	9.52
	Gas (Flare)	9.52	9.52	9.52	12.70	12.70	12.70	15.88
Drain Hose Diameter (I.D./O.D.)					25/32			
Cassette Grille	Model name	UTG-UNYA-W			UTG-UNYB-W			
	Net Dimensions (H × W × D)	mm 43 × 950 × 620			43 × 1,360 × 620			
	Weight	kg 6.5			8.5			

Note: Specifications are subject to the following conditions:
 Cooling: Indoor temperature of 27°CDB/19°CWB, and outdoor temperature of 35°CDB/24°CWB.
 Heating: Indoor temperature of 20°CDB/(15°CWB), and outdoor temperature of 7°CDB/6°CWB.
 Pipe length: 7.5 m; Height difference between outdoor unit and indoor unit: 0 m. Voltage: 230 [V]

Optional parts

*For more details, please refer to the chapter "Optional parts".

- WLAN adapter: UTY-TFSXZ1, UTY-TFSXJ3, FG-AC-WIFI21
 IR Receiver Unit: UTY-TRHX
 Cassette Grille: UTG-UNYA-W (004-012), UTG-UNYB-W (014-024)
 External power supply unit: UTZ-GXXA, UTZ-GXXC*
 Remote sensor kit: UTY-XSZX21

Flexible Installation

The L-shaped pipe kit allows for more flexible installation. Equipped with a built-in drain pump as standard, which enables a maximum pipe height difference of 700 m from the ceiling.

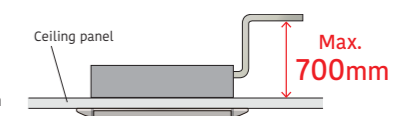

Dimensions

(Unit: mm)

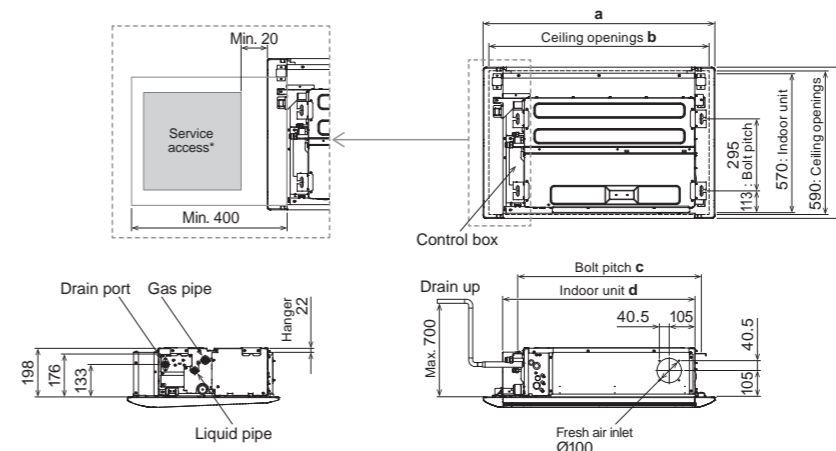

	AUXV 004 / 007 / 009 / 012 GLEH	AUXV 014 / 018 / 024 GLEH
a	950	1,360
b	920	1,330
c	752	1,152
d	785	1,190

*The design of the service access depends on the installation method. Refer to the installation manual for more information.

3D Flow Cassette



Model: AUXS018GLEH / AUXS024GLEH



3 individually controlled air outlet ports

The Comfortable airflow setting enables the left and right air outlet ports as well as the wide center port to work together to provide a comfortable room environment.

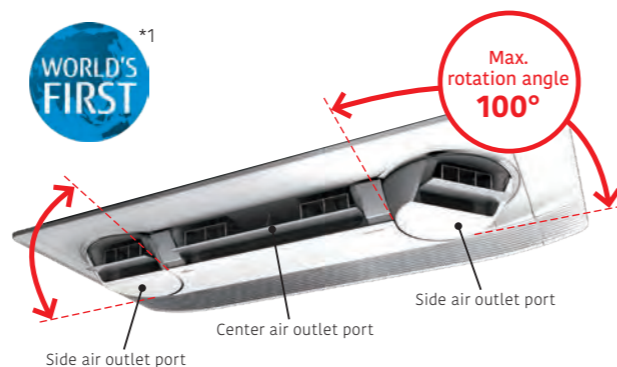

*1: Announced 2018. In the category of room air conditioners for the home (source: Fujitsu General Limited).

Temperature distribution during cooling and heating (when set to Comfortable airflow)



Testing conditions: Model AUXS024GLEH running cooling operation with the air volume set to "Hi" to maintain the room temperature at 18°C with the outdoor temperature at 35°C, tested in our 40m² environmental test room

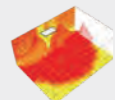

Testing conditions: Model AUXS024GLEH running heating operation with the air volume set to "Hi" to maintain the room temperature at 30°C with the outdoor temperature at 7°C, tested in our 40m² environmental test room

Individual airflow setting

The individual airflow setting function optimizes the airflow direction to match the room layout.

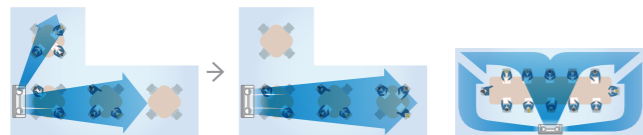

Adjusts airflows from the side air outlet ports to match the layout and usage of the room to minimize the amount of wasted airflow.

The airflow is optimally controlled to provide improved comfort in a narrow room.

Individual control of air outlet ports

Individual airflow can be set using a Wired remote controller with touch panel, Design type and Central remote controller*. The airflow from each air outlet port can be set individually.



* Feature available only on UTY-RNRYZ5 Wired remote controller with touch panel and UTY-DCGYZ3 Central remote controller

High energy saving

The structural design to take in a larger volume of air and blow air out more smoothly reduces air blowing loss and achieves class-leading energy-saving performance.

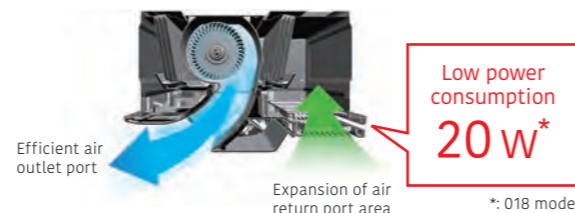

*: 018 model

Specifications

Model name		AUXS018GLEH	AUXS024GLEH
Power source		Single phase, ~230 V, 50 Hz	
Capacity	Cooling	5.60	7.10
	Heating	6.30	8.00
Input power		20/28	34/43
Airflow rate*	High	750/870	950/1,040
	Med-High	710/830	890/990
	Med	690/780	860/930
	Med-Low	660/740	810/880
	Low	630/700	770/840
	Quiet	540/540	540/540
Sound pressure level*	High	38/41	43/46
	Med-High	36/40	42/45
	Med	35/39	41/43
	Med-Low	35/37	40/42
	Low	33/36	38/40
	Quiet	29/29	29/29
Net Dimensions (H × W × D)		mm 200 × 1,240 × 500	200 × 1,240 × 500
Weight		kg 25	25
Connection pipe diameter	Liquid (Flare)	6.35	9.52
	Gas (Flare)	12.70	15.88
Drain Hose Diameter (I.D./O.D.)		25/32	
Cassette Grille	Model name	UTG-USYA-W	
	Net Dimensions (H × W × D)	mm 85 × 1,350 × 580	
	Weight	kg 11.5	

Note: Specifications are subject to the following conditions:
 Cooling: Indoor temperature of 27°CDB/19°CWB, and outdoor temperature of 35°CDB/24°CWB.
 Heating: Indoor temperature of 20°CDB/(15°CWB), and outdoor temperature of 7°CDB/6°CWB.
 Pipe length: 7.5 m; Height difference between outdoor unit and indoor unit: 0 m. Voltage: 230 [V]
 *: Applicable to cooling and heating operation

Optional parts

WLAN adapter: UTY-TFSXZ1, UTY-TFSXJ3, FG-AC-WIF1Z1
 IR Receiver Unit: UTY-TRHX

Cassette Grille: UTG-USYA-W
 Remote sensor kit: UTY-XSZXZ1

*For more details, please refer to the chapter "Optional parts".

Dimensions

(Unit: mm)

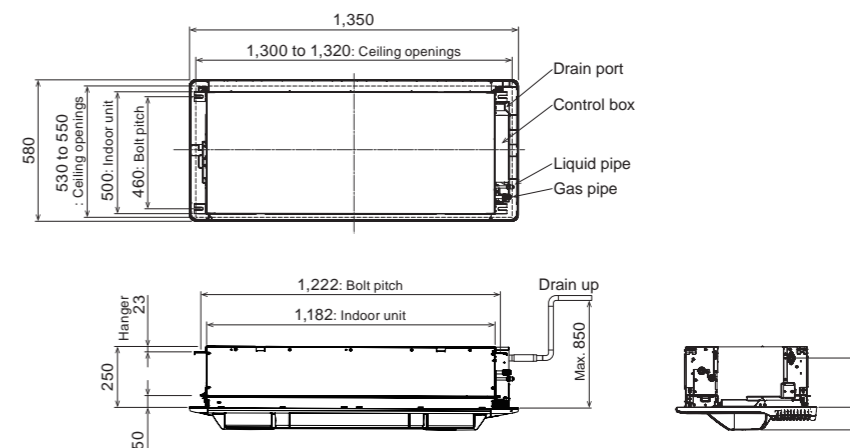

Low Static Pressure Duct Mini Duct (With drain pump)



Space saving design

- Fits into a space 198 mm high and 450 mm deep
- 30% smaller than previous-generation models
- Weighs 16 kg, 10% lighter

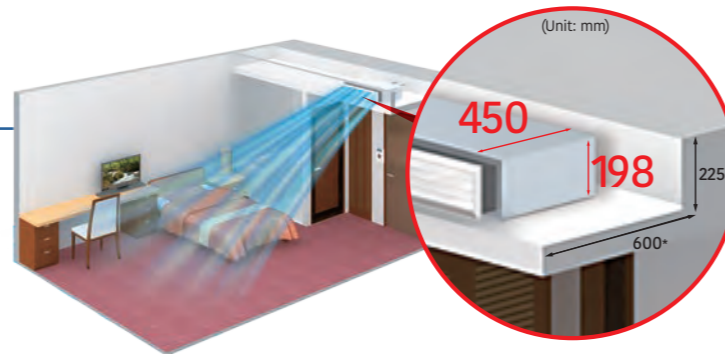

Optimum airflow path and low noise operation

The stabilized airflow reduces the noise level significantly.

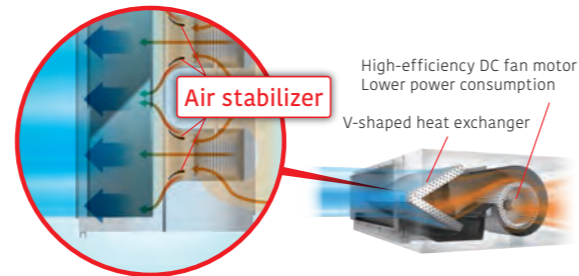

6-speed control*

Multistep airflow adjustment allows installation in a quiet location.

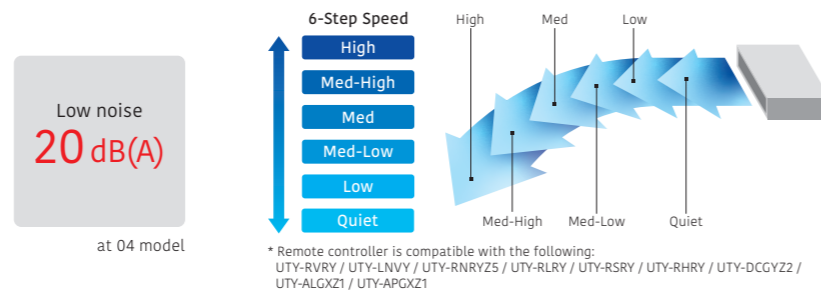

Easy to design and maintain for drain

Indoor unit design for easy maintenance. Parts can be replaced from the side of the unit where maintenance is easier.

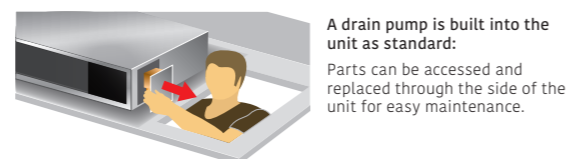

Model: ARXK004GLGH / ARXK007GLGH / ARXK009GLGH
ARXK012GLGH / ARXK014GLGH / ARXK018GLGH
ARXK024GLGH

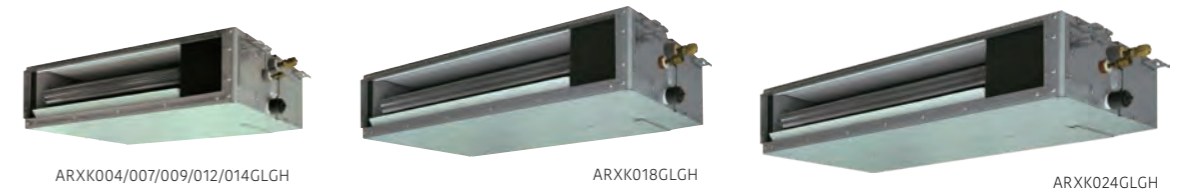

Specifications

Model name	ARXK004GLGH	ARXK007GLGH	ARXK009GLGH	ARXK012GLGH	ARXK014GLGH	ARXK018GLGH	ARXK024GLGH	
Power source	Single phase, ~230 V, 50 Hz							
Capacity	Cooling	1.1	2.2	2.8	3.6	4.5	7.1	
	Heating	1.3	2.8	3.2	4.0	5.0	8.0	
Input power	W	26	28	28	35	66	80	
Airflow rate	High	460	460	460	550	760	1,160	
	Med-High	440	440	440	520	660	1,060	
	Med	420	420	420	480	560	960	
	Med-Low	400	400	400	450	490	860	
	Low	370	370	370	410	410	750	
Quiet	340	340	340	340	340	470	610	
Static pressure range	Pa	0 to 30	0 to 30	0 to 30	0 to 30	0 to 50	0 to 50	
Standard static pressure		10	10	10	10	15	15	
Sound pressure level	High	25	26	26	29	34	32	
	Med-High	24	25	25	27	31	30	
	Med	23	24	24	26	28	28	
	Med-Low	22	23	23	25	26	27	
	Low	21	22	22	24	24	25	
Quiet	20	21	21	22	22	22		
Net Dimensions (H × W × D)	mm	198 × 700 × 450	198 × 700 × 450	198 × 700 × 450	198 × 700 × 450	198 × 700 × 450	198 × 900 × 450	
Weight	kg	14.5	15.5	15.5	16	16	22.5	
Connection pipe diameter	Liquid (Flare)	6.35	6.35	6.35	6.35	6.35	9.52	
	Gas (Flare)	9.52	9.52	9.52	12.70	12.70	15.88	
Drain Hose Diameter (I.D./O.D.)		25/32						

Note: Specifications are subject to the following conditions:
Cooling: Indoor temperature of 27°CDB/19°CWB, and outdoor temperature of 35°CDB/24°CWB.
Heating: Indoor temperature of 20°CDB/(15°CWB), and outdoor temperature of 7°CDB/6°CWB.
Pipe length: 7.5 m; Height difference between outdoor unit and indoor unit: 0 m. Voltage: 230 [V].

Optional parts

*For more details, please refer to the chapter "Optional parts".

- Remote sensor unit: UTY-XSZXZ1
- IR receiver unit: UTY-TRHX
- Silver Ion Filter: UTD-HFTA (004-014), UTD-HFTB (018), UTD-HFTC (024)
- External power supply unit: UTZ-GXXA, UTZ-GXXC*
- Auto Louver Grille Kit: UTD-GXTA-W (004-014), UTD-GXTB-W (018), UTD-GXTC-W (024)
- WLAN adapter: FG-AC-WIFI21, UTY-TFSXJ3, UTY-TFSXZ1 (007-024)

Auto Louver Grille Kit (Optional)

The slim design of the unit provides comfortable cooling and heating air conditioning over a wide area. The optional automatic louver grille, which fits nicely into any interior decor, provides comfortable air conditioning (Optional).

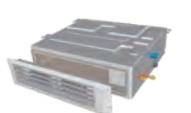

Dimensions

(Unit: mm)

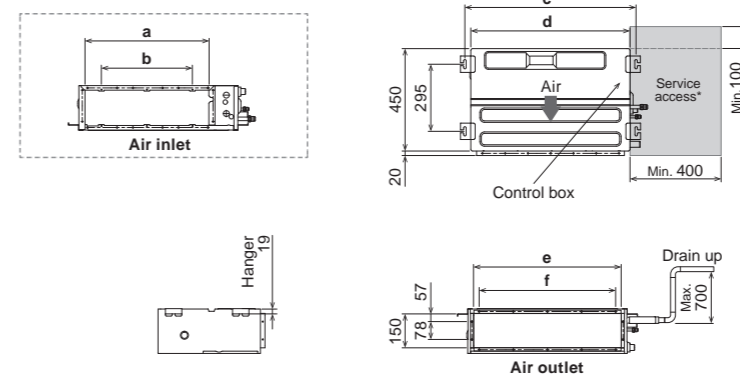

	ARXK 004-014GLGH	ARXK018GLGH	ARXK024GLGH
a	575	775	975
b	P200x2=400	P200x3=600	P200x4=800
c	752	952	1,152
d	700	900	1,100
e	650	850	1,050
f	P100x6=600	P100x8=800	P100x10=1,000

*The design of the service access depends on the installation method. Refer to the installation manual for more information.

Low Static Pressure Duct Slim Duct/ Slim Concealed Floor



Slim design

Slim design allows for installation in a tight ceiling space.

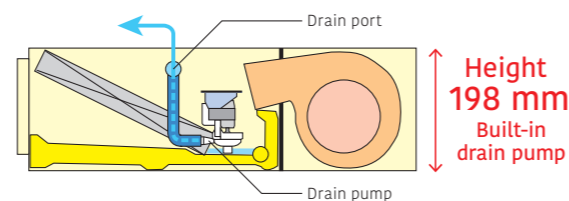

Air intake

Air intake direction can be selected to match the installation site.

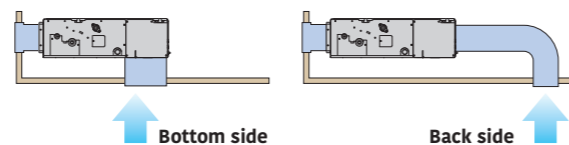

Flexible installation

Ceiling concealed

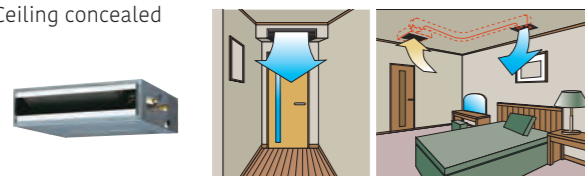

Floor concealed

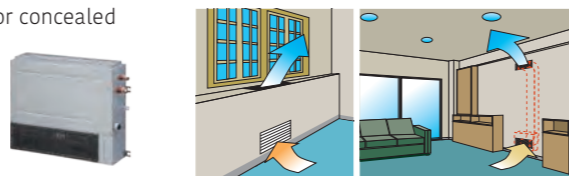

Wide range of static pressures

The use of a DC fan motor makes it possible to adjust the static pressure between 0 and 90 Pa. The static pressure range can be changed by a remote controller.



Static pressure range
0 to 90 Pa

*024 model static pressure range is 0 to 50 Pa.

Filter (Accessory)

ARXD04/007/009/012/014/018 ARXD024

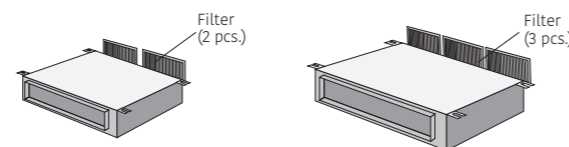

Model: ARXD04GALH / ARXD007GLEH / ARXD009GLEH
ARXD012GLEH / ARXD014GLEH / ARXD018GLEH
ARXD024GLEH



ARXD04GALH
ARXD007/009/012/014GLEH



ARXD018GLEH



ARXD024GLEH



Specifications

Model name		ARXD04GALH*	ARXD007GLEH	ARXD009GLEH	ARXD012GLEH	ARXD014GLEH	ARXD018GLEH	ARXD024GLEH
Power source		Single phase, ~230 V, 50 Hz						
Capacity	Cooling	1.1	2.2	2.8	3.6	4.5	5.6	7.1
	Heating	1.3	2.8	3.2	4.0	5.0	6.3	8.0
Input power		40	44	50	54	92	83	122
Airflow rate	High	510	550	600	600	800	940	1,330
	Med-High	-	480	510	530	680	820	1,140
	Med	400/470*	440	460	490	600	730	1,020
	Med-Low	-	410	420	450	520	630	900
	Low	320/440*	370	370	410	440	540	780
Quiet		-	320	320	340	340	470	610
Static pressure range		0 to 90	0 to 90	0 to 90	0 to 90	0 to 90	0 to 90	0 to 50
Standard static pressure		25	25	25	25	25	25	25
Sound pressure level	High	26	28	29	30	34	34	35
	Med-High	-	26	27	28	32	31	31
	Med	21/25*	25	25	27	30	29	29
	Med-Low	-	24	24	26	28	27	27
	Low	20/22*	22	22	24	25	25	24
Quiet		-	21	21	22	22	23	21
Net Dimensions (H × W × D)		mm 198 × 700 × 620	198 × 700 × 620	198 × 700 × 620	198 × 700 × 620	198 × 700 × 620	198 × 900 × 620	198 × 1,100 × 620
Weight		kg 17	17	17	18	18	22	26
Connection pipe diameter	Liquid (Flare)	6.35	6.35	6.35	6.35	6.35	6.35	9.52
	Gas (Flare)	12.70	9.52	9.52	12.70	12.70	12.70	15.88
Drain Hose Diameter (I.D./O.D.)		25/32						

Note: Specifications are subject to the following conditions:
Cooling: Indoor temperature of 27°CDB/19°CWB, and outdoor temperature of 35°CDB/24°CWB.
Heating: Indoor temperature of 20°CDB/(15°CWB), and outdoor temperature of 7°CDB/6°CWB.
Pipe length: 7.5 m; Height difference between outdoor unit and indoor unit: 0 m. Voltage: 230 [V].
*1: This value is under cooling operation.
*: ARXD04GALH cannot be connected to J-IVS/J-IVJ-IVL/VR-IV Series.

Optional parts

*For more details, please refer to the chapter "Optional parts".

- Remote sensor unit: UTU-XSZXZ1
- IR receiver unit: UTB-YWC (04)
UTY-TRHX (007-024)
UTY-TFSXJ3 (007-024)
UTY-TFSXZ1 (007-024)
FG-RC-WIF1Z2 (04)
FG-AC-WIF1Z1 (007-024)
- External power supply unit: UTZ-GXXA, UTZ-GXXC*
- Auto Louver Grille Kit: UTD-GXTA-W (04, 007-014)
UTD-GXTB-W (018)
UTD-GXTC-W (024)
UTD-HFTA (04, 007-014)
UTD-HFTB (018)
UTD-HFTC (024)
- Silver Ion Filter:

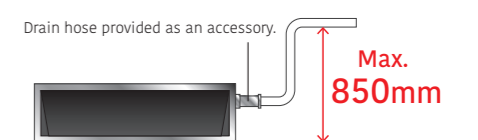

Dimensions

(Unit: mm)

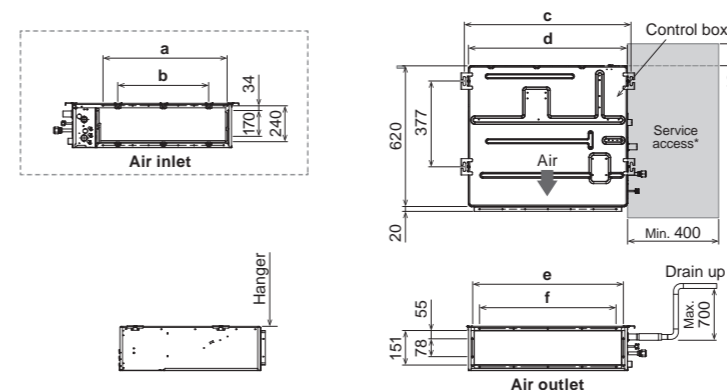

	ARXD04GALH ARXD007-014GLEH	ARXD018GLEH	ARXD024GLEH
a	574	774	974
b	P200x2=400	P200x3=600	P200x4=800
c	734	934	1,134
d	700	900	1,100
e	650	850	1,050
f	P100x6=600	P100x8=800	P100x10=1,000

*The design of the service access depends on the installation method. Refer to the installation manual for more information.

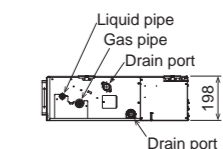

Low Static Pressure Duct

High Efficiency



Slim & Compact design

The slim and compact design of the indoor unit, with the control box mounted on the side, allows installation in narrow spaces.

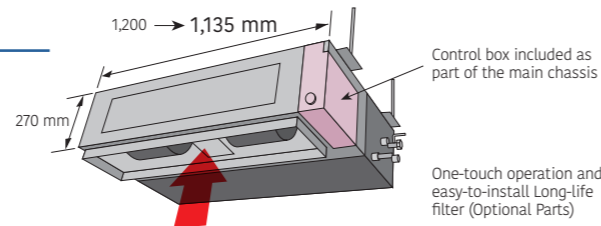

Easy maintenance

Structural improvement has been developed by making the bottom panel in two pieces, front and rear. The internal fan casing is also manufactured in two pieces—upper and lower. The motor and fan can be easily accessed and maintained by removing the rear panel and the lower casing with the main chassis remaining in place.

See below for rear-suction type

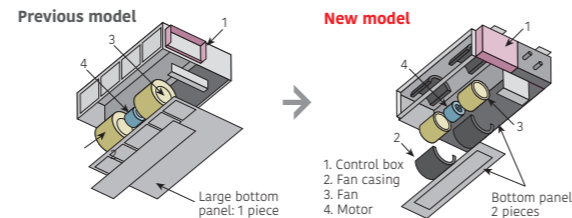

Installation styles

Embedded in Ceiling

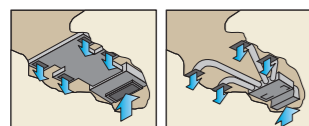

Hanging from Ceiling

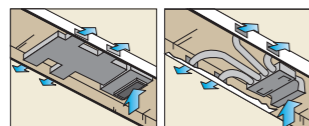

A drain pipe can be installed on either the left or right side of the unit

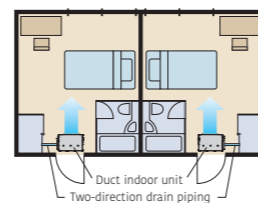

High-efficiency DC fan motor achieves low-energy consumption.

Improved motor efficiency from previous model.

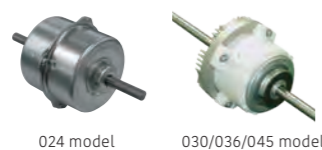

Wide range of static pressures

Static pressures can be changed in the range of 0 to 80 Pa.

Static pressure range
0 to 80 Pa

Model: ARXP018GLFH / ARXP030GLFH * Production by order

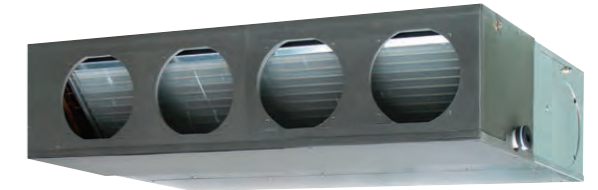

Specifications

Model name		ARXP018GLFH	ARXP030GLFH
Power source		Single-phase, ~220V, 50Hz	
Capacity	Cooling	5.6	9.0
	Heating	6.3	10.0
Input power		128	228
Airflow rate	High	1,540 / 1,440	1,940 / 1,660
	Med-High	1,460 / 1,380	1,810 / 1,580
	Med	1,380 / 1,320	1,680 / 1,510
	Med-Low	1,300 / 1,260	1,550 / 1,440
	Low	1,220 / 1,200	1,420 / 1,370
Static pressure range		0 to 80	0 to 80
Standard static pressure		40	50
Sound pressure level	High	35 / 34	39 / 36
	Med-High	34 / 32	38 / 35
	Med	32 / 31	36 / 34
	Med-Low	31 / 30	34 / 33
	Low	29 / 29	32 / 31
Net Dimensions (H × W × D)		270 × 1,135 × 700	270 × 1,135 × 700
Weight		40	40
Connection pipe diameter	Liquid (Flare)	6.35	9.52
	Gas (Flare)	12.70	15.88
Drain Hose Diameter (I.D./O.D.)		25/32	

Note: Specifications are subject to the following conditions:
Cooling: Indoor temperature of 27°CDB/19°CWB, and outdoor temperature of 35°CDB/24°CWB.
Heating: Indoor temperature of 20°CDB/(15°CWB), and outdoor temperature of 7°CDB/6°CWB.
Pipe length: 7.5 m; Height difference between outdoor unit and indoor unit: 0 m. Voltage: 230 [V].

Optional parts

*For more details, please refer to the chapter "Optional parts".

Long-life filter: UTD-LF25NA
Flange (square): UTD-SF045T
Flange (round): UTD-RF204

External power supply unit: UTZ-GXXA, UTZ-GXXC*
Remote sensor unit: UTY-XSZXZ1
IR receiver unit: UTY-TRHX

Drain pump unit: UTZ-PX1NBA
WLAN adapter: UTY-TFSXZ1, UTY-TFSXJ3, FG-AC-WIF1Z1
Silver Ion Filter: UTD-HFND

Dimensions

(Unit: mm)

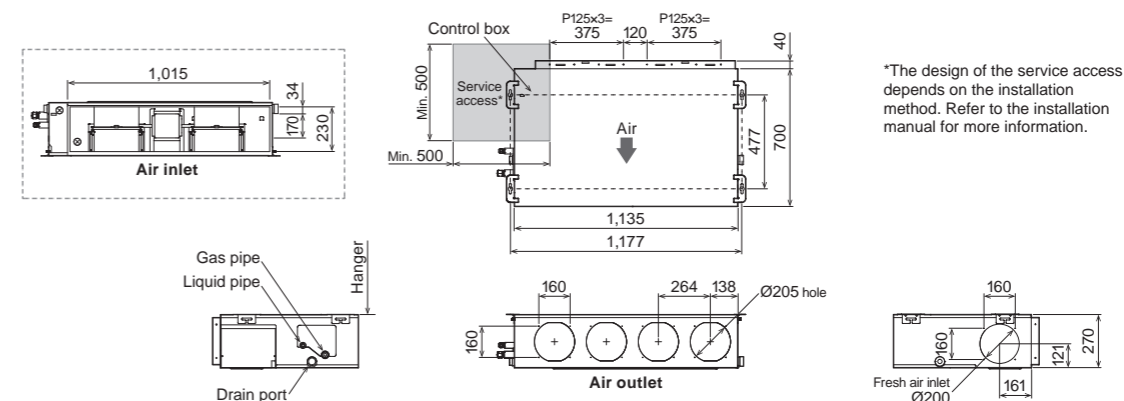

Medium Static Pressure Duct Normal



Slim & Compact design

The slim and compact design of the indoor unit, with the control box mounted on the side, allows installation in narrow spaces.

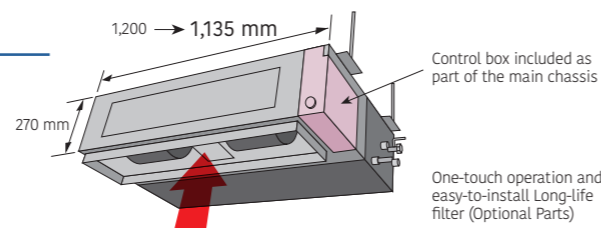

Easy maintenance

Structural improvement has been developed by making the bottom panel in two pieces, front and rear. The internal fan casing is also manufactured in two pieces—upper and lower. The motor and fan can be easily accessed and maintained by removing the rear panel and the lower casing with the main chassis remaining in place.

See below for rear-suction type

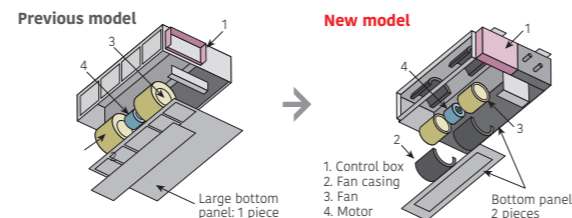

Installation styles

Embedded in Ceiling

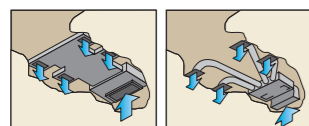

Hanging from Ceiling

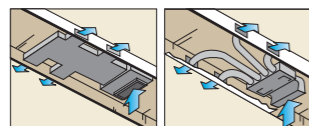

A drain pipe can be installed on either the left or right side of the unit

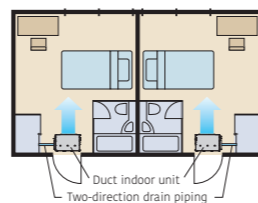

High-efficiency DC fan motor achieves low-energy consumption.

Improved motor efficiency from previous model.

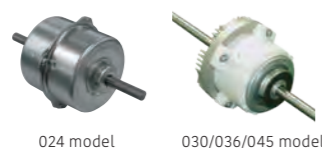

Wide range of static pressures

Static pressures can be changed in the range of 0 to 150 Pa.

Static pressure range
0 to 150 Pa

Model: ARXA024GLEH / ARXA030GLEH / ARXA036GLEH / ARXA045GLEH



Specifications

Model name		ARXA024GLEH	ARXA030GLEH	ARXA036GLEH	ARXA045GLEH
Power source		Single phase, ~230 V, 50 Hz			
Capacity	Cooling	7.1	9.0	11.2	12.5
	Heating	8.0	10.0	12.5	14.0
Input power		94	108	194	240
Airflow rate	High	1,280	1,410	1,840	1,970
	Med-High	1,180	1,350	1,750	1,910
	Med	1,090	1,280	1,660	1,860
	Med-Low	1,000	1,240	1,600	1,780
	Low	920	1,190	1,530	1,710
Quiet		840	1,150	1,470	1,640
Static pressure range		0 to 150	0 to 150	0 to 150	0 to 150
Standard static pressure		40	50	50	60
Sound pressure level	High	31	34	37	41
	Med-High	29	33	36	40
	Med	27	32	35	38
	Med-Low	26	31	35	38
	Low	24	30	34	37
Quiet		23	29	33	36
Net Dimensions (H × W × D)		mm 270 × 1,135 × 700	mm 270 × 1,135 × 700	mm 270 × 1,135 × 700	mm 270 × 1,135 × 700
Weight		kg 36	kg 40	kg 40	kg 40
Connection pipe diameter	Liquid (Flare)	9.52	9.52	9.52	9.52
	Gas (Flare)	15.88	15.88	15.88	15.88
Drain Hose Diameter (I.D./O.D.)		25/32			

Note: Specifications are subject to the following conditions:
Cooling: Indoor temperature of 27°CDB/19°CWB, and outdoor temperature of 35°CDB/24°CWB.
Heating: Indoor temperature of 20°CDB/(15°CWB), and outdoor temperature of 7°CDB/6°CWB.
Pipe length: 7.5 m; Height difference between outdoor unit and indoor unit: 0 m. Voltage: 230 [V].

Optional parts

*For more details, please refer to the chapter "Optional parts".

Long-life filter: UTD-LF25NA
Flange (square): UTD-SF045T
Flange (round): UTD-RF204

External power supply unit: UTZ-GXXA, UTZ-GXXC*
Remote sensor unit: UTY-XSZXZ1
IR receiver unit: UTY-TRHX

Drain pump unit: UTZ-PX1NBA
WLAN adapter: UTY-TFSXZ1, UTY-TFSXJ3, FG-AC-WIF1Z1
Silver Ion Filter: UTD-HFND

Dimensions

(Unit: mm)

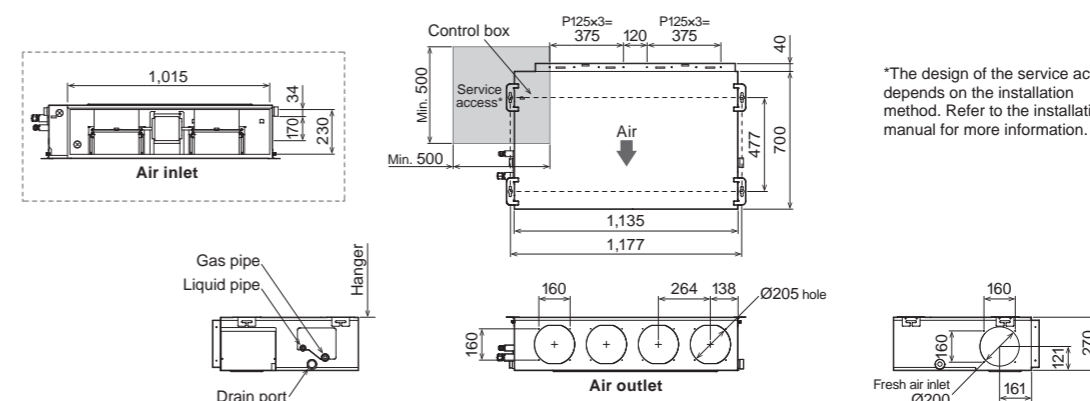

*The design of the service access depends on the installation method. Refer to the installation manual for more information.

High Static Pressure Duct Normal



Model: ARXC036GTEH / ARXC045GTEH / ARXC060GTEH
ARXC072GTEH / ARXC090GTEH / ARXC096GTEH



ARXC036/045/060GTEH



ARXC072/090GTEH



ARXC096GTEH

Static pressure mode selection

The use of a DC fan motor makes it possible to adjust the static pressure between 0 to 200 Pa (ARXC036) / 250 Pa (ARXC045/060) / 300 Pa (ARXC072/090/096)

MAX. 200 Pa (036 type)



(ARXC036/045/060 type)

MAX. 250 Pa (045/060 type)



(ARXC072/090 type)

MAX. 300 Pa



(ARXC096 type)

MAX. 300 Pa

Easy installation (Compact & Lightweight)

The indoor unit is designed to be compact and light by reducing the basic chassis size and the overall material weight.

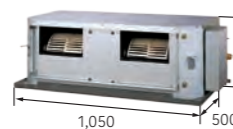

(ARXC036/045/060 type)

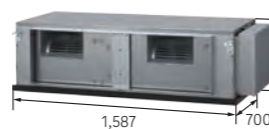

(ARXC072/090 type)



(ARXC096 type)

(Unit: mm)

Low noise

Models: ARXC036/ARXC045/ARXC060

The corners of the front panel and fan casing of the indoor unit are shaved to reduce air turbulence. The use of a plastic case and fan reduces the noise level generated by the unit.

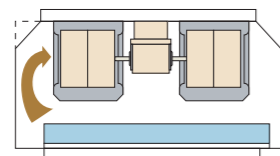

ARXC036GTEH:
Plastic fan [42 dB(A)]
* Model: Material (Actual noise measurement value measured at 100 Pa)

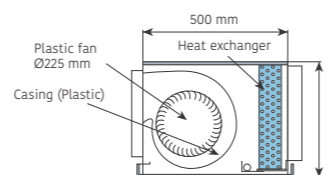

High-efficiency DC fan motor achieves low energy consumption.

Improved motor efficiency compared to the previous model



(ARXC036/045/060 type)



(ARXC072/090/096 type)

Specifications

Model name	ARXC036GTEH	ARXC045GTEH	ARXC060GTEH*	ARXC072GTEH*	ARXC090GTEH*	ARXC096GTEH*	
Power source	Single phase, ~230 V, 50 Hz						
Capacity	Cooling	11.2	12.5	18.0	22.4	28.0	
	Heating	12.5	14.0	20.0	25.0	28.0	31.5
Input power	W	207	715	730	681	819	838
Airflow rate	High	1,990	3,500	3,500	3,900	4,300	4,850
	Med	1,680	3,000	3,000	3,300	4,000	4,250
	Low	1,330	2,460	2,460	3,000	3,500	3,600
Static pressure range	Pa	0 to 200	100 to 250	100 to 250	0 to 300	0 to 300	0 to 300
Standard static pressure	Pa	100	100	100	150	150	150
Sound pressure level	High	42	49	49	47	48	48
	Med	36	45	45	43	46	45
	Low	32	42	42	40	44	42
Net Dimensions (H × W × D)	mm	400 × 1,050 × 500	400 × 1,050 × 500	400 × 1,050 × 500	450 × 1,587 × 700	450 × 1,587 × 700	550 × 1,587 × 700
Weight	kg	40	46	46	84	84	105
Connection pipe diameter	Liquid	9.52 (Flare)	9.52 (Flare)	9.52 (Flare)	9.52 (Flare)	9.52 (Flare)	9.52 (Brazing)
	Gas	15.88 (Flare)	15.88 (Flare)	15.88 (Flare)	19.05 (Flare)	19.05 (Flare)	22.22 (Brazing)
Drain Hose Diameter (I.D./O.D.)						25/32	

Note: Specifications are based on the following conditions:

Cooling: Indoor temperature of 27°CDB/19°CWB, and outdoor temperature of 35°CDB/24°CWB.

Heating: Indoor temperature of 20°CDB/(15°CWB), and outdoor temperature of 7°CDB/6°CWB.

Pipe length: 7.5 m; Height difference between outdoor unit and indoor unit: 0 m. Voltage: 230 [V]

*: ARXC060/072/090/096G cannot be connected to J-IV/J-IVS Series.

Optional parts

Long-life filter: UTD-LF60KA (036/045/060)
IR receiver unit: UTY-TRHX

External power supply unit: UTZ-GXXA, UTZ-GXXC*
Remote sensor unit: UTY-XSZXZ1

WLAN adapter: UTY-TFSXZ1, UTY-TFSXJ3, FG-AC-WIF1Z1
Silver Ion Filter: UTD-HFKB (036/045/060)

*For more details, please refer to the chapter "Optional parts".

Dimensions

(Unit: mm)

Models: ARXC036/ARXC045/ARXC060

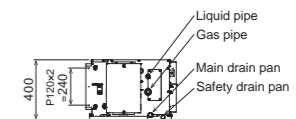
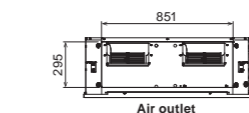
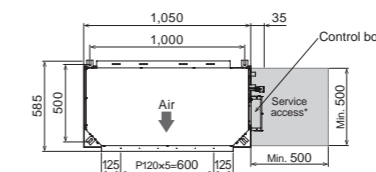
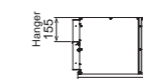
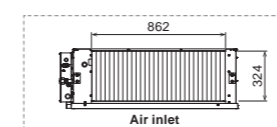

*The design of the service access depends on the installation method. Refer to the installation manual for more information.

Models: ARXC072/ARXC090/ARXC096

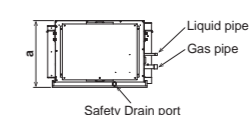
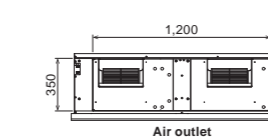
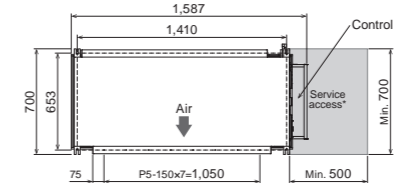
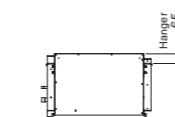
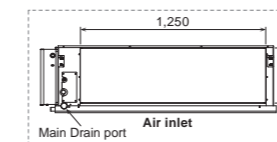

	ARXC072/090 GTEH	ARXC096 GTEH
a	450	550
b	370	470

*The design of the service access depends on the installation method. Refer to the installation manual for more information.

Compact floor



**Model: AGYA004GCGH / AGYA007GCGH / AGYA009GCGH
AGYA012GCGH / AGYA014GCGH**
**[external EEV]
AGYE004GCEH / AGYE007GCEH / AGYE009GCEH
AGYE012GCEH / AGYE014GCEH**



Specifications

Model name		AGYA004GCGH	AGYA007GCGH	AGYA009GCGH	AGYA012GCGH	AGYA014GCGH	AGYE004GCEH	AGYE007GCEH	AGYE009GCEH	AGYE012GCEH	AGYE014GCEH	
Power source		Single phase, ~230 V, 50 Hz						Single phase, ~230 V, 50 Hz				
Capacity	Cooling	1.1	2.2	2.8	3.6	4.0	1.1	2.2	2.8	3.6	4.0	
	Heating	1.3	2.8	3.2	4.0	4.5	1.3	2.8	3.2	4.0	4.5	
Input power		12/14	16	17	22	29	14	16	17	22	29	
Airflow rate	High	380/430	470	500	590	670	380/430	470	500	590	670	
	Med-High	350	420	450	520	590	350	420	450	520	590	
	Med	320	390	400	470	520	320	390	400	470	520	
	Med-Low	310	360	360	420	450	310	360	360	420	450	
	Low	280	330	330	390	390	280	330	330	390	390	
Sound pressure level	High	35/36	37	38	42	46	35/36	37	38	42	46	
	Med-High	33	35	36	39	42	33	35	36	39	42	
	Med	31	33	34	37	39	31	33	34	37	39	
	Med-Low	30	31	31	35	36	30	31	31	35	36	
	Low	28	29	29	33	33	28	29	29	33	33	
Quiet	22	22	22	30	30	22	22	22	30	30		
Net Dimensions (H × W × D)		600 × 740 × 200						600 × 740 × 200				
Weight		15.0	15.0	15.0	15.0	15.0	14.5	14.5	14.5	14.5	14.5	
Connection pipe diameter	Liquid (Flare)	6.35	6.35	6.35	6.35	6.35	6.35	6.35	6.35	6.35	6.35	
	Gas (Flare)	9.52	9.52	9.52	12.70	12.70	9.52	9.52	9.52	12.70	12.70	
Drain Hose Diameter (I.D./O.D.)		13.8/15.8 to16.7						13.8/15.8 to16.7				
EV kit (optional)								UTR-EV09XB		UTR-EV14XB		

2-fan and wide airflow

A 2-fan individual vertical airflow cools or warms the entire room comfortably.

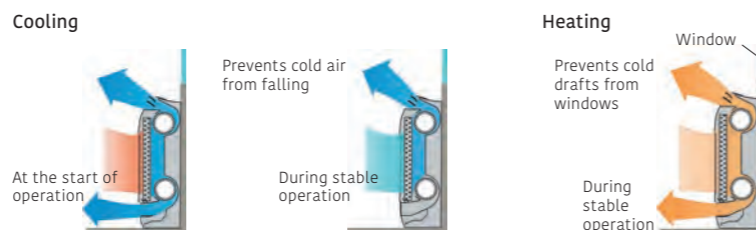

Flexible and easy installation

The compact and whole-surface suction design provides flexible installation options, including floor-standing, embedded, partially embedded, and wall-mounted installation to match the room layout.

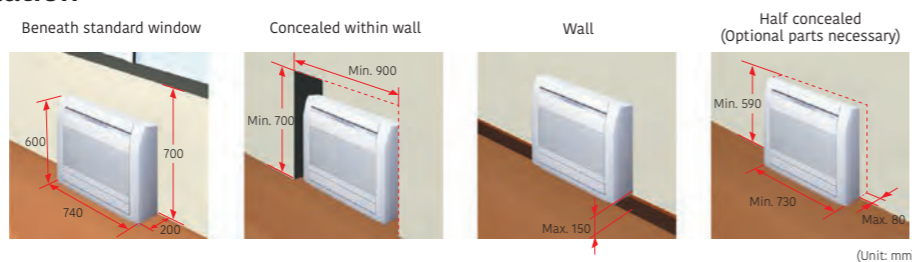

Quiet operation

6-fan speed control for quiet operation (via 2-wire controller)

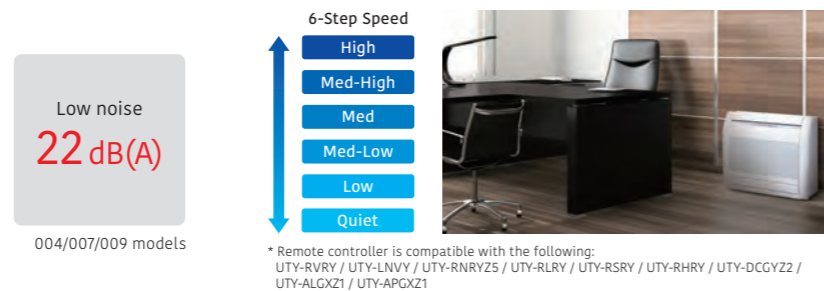

Flexible pipe connection enables draining and piping in 6 directions

The drain hose and pipe can be connected to the unit in the right, left, straight in depth, or downward direction.

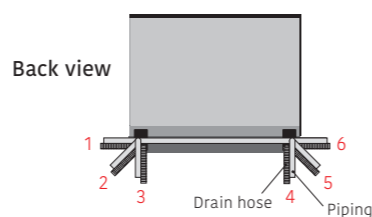

Optional parts

Partially concealing kit: UTR-STA
Silver Ion Filter: UTR-FA03-S
External power supply unit: UTZ-GXXA, UTZ-GXXC*
WLAN adapter: UTY-TFSXZ1, UTY-TFSXJ3, FG-AC-WIF1Z1

*For more details, please refer to the chapter "Optional parts".

Dimensions

(Unit: mm)

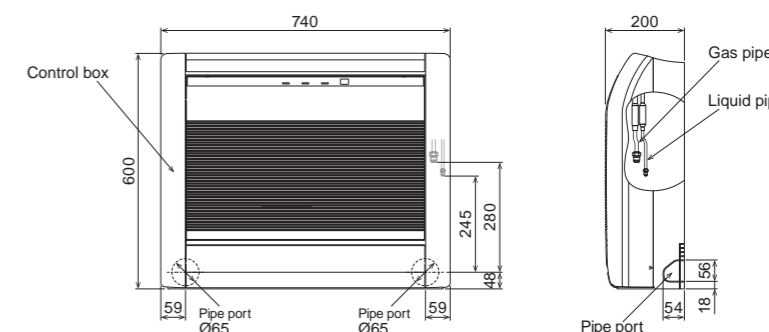

Floor/Ceiling



Flexible installation

Example of floor standing installation

Floor standing console with the back against the wall



Example of ceiling installation

Under ceiling



Double auto swing

The combination of horizontal and vertical swings enables 3-dimensional control of the airflow direction.

RIGHT and LEFT SWING

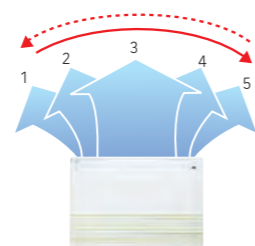

UP and DOWN SWING

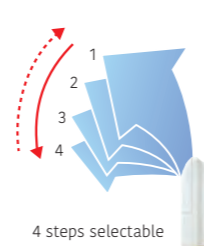

High-power DC fan motor

- High power
- Wide rotation range
- High-efficiency



Compact design

Symmetrical, slim and compact design.



(Unit: mm)

Model: ABYA012GTEH / ABYA014GTEH / ABYA018GTEH / ABYA024GTEH



Floor standing



Specifications

Model name		ABYA012GTEH	ABYA014GTEH	ABYA018GTEH	ABYA024GTEH
Power source		Single phase, ~230 V, 50 Hz			
Capacity	Cooling	3.6	4.5	5.6	7.1
	Heating	4.0	5.0	6.3	8.0
Input power		30	42	74	99
Airflow rate	High	660	780	1,000	1,000
	Med-High	620	740	910	930
	Med	580	690	830	870
	Med-Low	550	640	750	800
	Low	520	600	660	740
	Quiet	490	550	580	680
Sound pressure level	High	36	40	46	47
	Med-High	34	39	44	45
	Med	33	38	42	43
	Med-Low	31	36	40	41
	Low	29	35	37	39
	Quiet	28	34	35	37
Net Dimensions (H × W × D)		mm 199 × 990 × 655	mm 199 × 990 × 655	mm 199 × 990 × 655	mm 199 × 990 × 655
Weight		kg 25	kg 26	kg 26	kg 27
Connection pipe diameter	Liquid (Flare)	6.35	6.35	6.35	9.52
	Gas (Flare)	12.70	12.70	12.70	15.88
Drain Hose Diameter (I.D./O.D.)		25/32			

Note: Specifications are subject to the following conditions:
 Cooling: Indoor temperature of 27°CDB/19°CWB, and outdoor temperature of 35°CDB/24°CWB.
 Heating: Indoor temperature of 20°CDB/(15°CWB), and outdoor temperature of 7°CDB/6°CWB.
 Pipe length: 7.5 m; Height difference between outdoor unit and indoor unit: 0 m. Voltage: 230 [V]

Optional parts

*For more details, please refer to the chapter "Optional parts".

- External power supply unit: UTZ-GXXA, UTZ-GXXC*
- WLAN adapter: UTY-TFSXZ1, UTY-TFSXJ3, FG-AC-WIF1Z1
- Remote sensor unit: UTY-XSZXZ1

Dimensions

(Unit: mm)

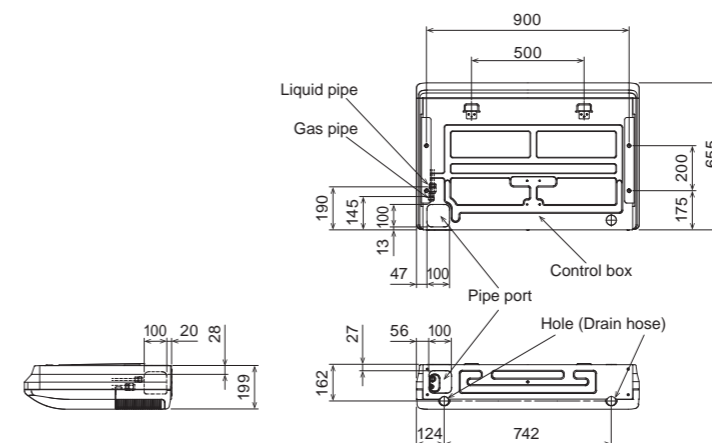

Ceiling



Model: ABYA030GTEH / ABYA036GTEH / ABYA045GTEH / ABYA054GTEH

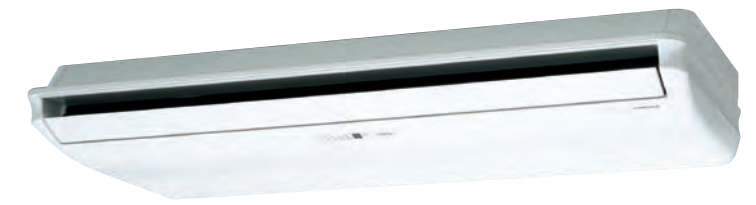

Specifications

Model name		ABYA030GTEH	ABYA036GTEH	ABYA045GTEH	ABYA054GTEH
Power source		Single phase, ~230 V, 50 Hz			
Capacity	Cooling	9.0	11.2	12.5	14.0
	Heating	10.0	12.5	14.0	16.0
Input power		66	85	131	180
Airflow rate	High	1,630	1,690	2,010	2,270
	Med-High	1,520	1,560	1,840	2,070
	Med	1,420	1,450	1,690	1,860
	Med-Low	1,320	1,360	1,530	1,660
	Low	1,220	1,270	1,380	1,470
	Quiet	1,140	1,170	1,230	1,280
Sound pressure level	High	42	45	48	51
	Med-High	40	41	46	49
	Med	39	39	45	46
	Med-Low	37	38	41	43
	Low	35	36	38	40
	Quiet	33	34	35	36
Net Dimensions (H × W × D)		mm 240 × 1,660 × 700	240 × 1,660 × 700	240 × 1,660 × 700	240 × 1,660 × 700
Weight		kg 46	48	48	48
Connection pipe diameter	Liquid (Flare)	9.52	9.52	9.52	9.52
	Gas (Flare)	15.88	15.88	15.88	15.88
Drain Hose Diameter (I.D./O.D.)		25/32			

Note: Specifications are subject to the following conditions:
 Cooling: Indoor temperature of 27°CDB/19°CWB, and outdoor temperature of 35°CDB/24°CWB.
 Heating: Indoor temperature of 20°CDB/(15°CWB), and outdoor temperature of 7°CDB/6°CWB.
 Pipe length: 7.5 m; Height difference between outdoor unit and indoor unit: 0 m. Voltage: 230 [V]

Installation

Open

General installation with indoor unit installed on the ceiling

Concealed

Installation with indoor unit embedded into the ceiling

Wall-mounted type (Locally Available)

Wall-mounting brackets are used to mount the indoor unit on the wall. (Locally available)
This type of installation is used when the ceiling space is insufficient.

Double auto swing and wide airflow

Auto airflow direction and auto swing

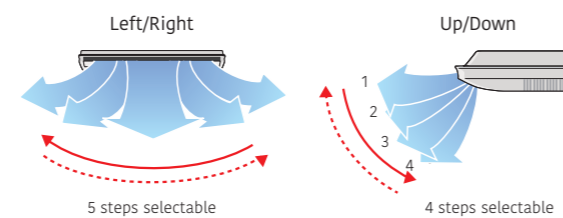

High-power DC fan motor

- High power
- Wide rotation range
- High-efficiency



Long airflow

Long airflow provides comfort in every corner of a large room.

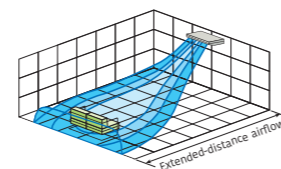

Fresh air intake

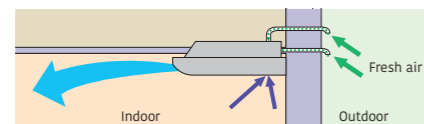

Slim & Compact design



Optional parts

*For more details, please refer to the chapter "Optional parts".

- Drain pump unit: UTR-DPB24T
- Flange: UTD-RF204
- External power supply unit: UTZ-GXXA, UTZ-GXXC*
- WLAN adapter: UTY-TFSXZ1, UTY-TFSXJ3, FG-AC-WIFI21
- Remote sensor unit: UTY-XSZXZ1

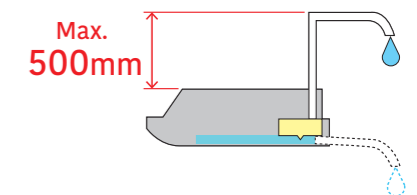

Dimensions

(Unit: mm)

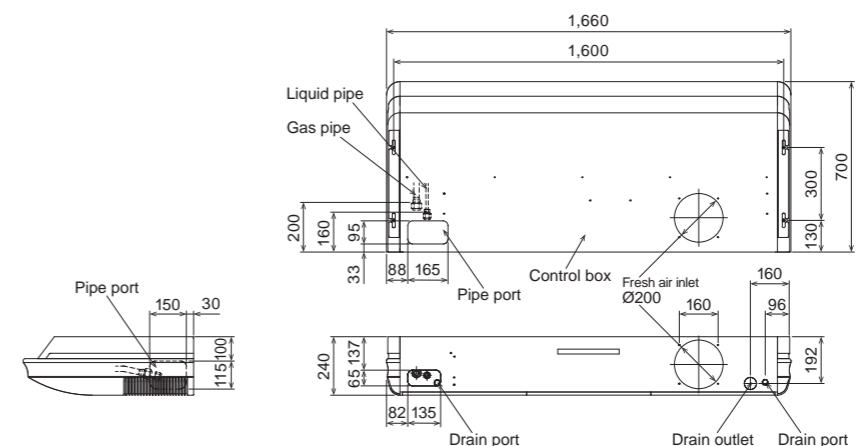

Wall-mounted type



Highly-efficiency, compact design

The 004-014 models share the same design. The high-density and large heat exchanger achieves a highly-efficiency and compact design. The compact body blends in well with conference rooms and offices, providing comfortable air conditioning.

High-density heat exchanger

Slim tube design: 5 mm
Greater heat-exchanging capacity is achieved through the use of a high-density heat exchanger and a sub-heat exchanger.

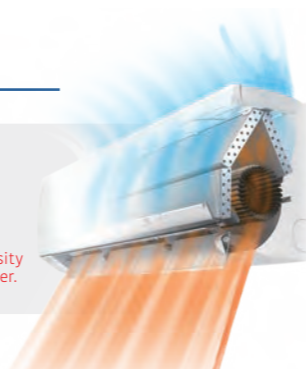

More comfortable airflow

The unique power diffuser provides comfortable air conditioning.

Heating

The vertical airflow provides powerful floor-level heating.



Cooling

The left/right airflow avoids blowing cool air directly at the occupants in a room.



Quiet operation & 6-Step fan speed control

The airflow pattern achieves significant noise reduction. Multistep airflow adjustment to suit the environment

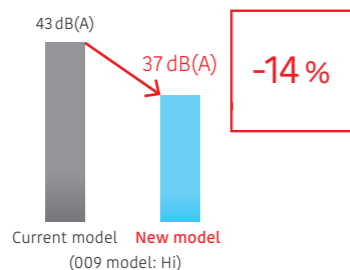

- 6-Step Speed
- High
- Med-High
- Med
- Med-Low
- Low
- Quiet

* Remote controller is compatible with the following:
UTY-RVRY / UTY-LNVY / UTY-RNRYZ5 / UTY-RLRY / UTY-RSRY / UTY-RHRY / UTY-DCGYZ2 / UTY-ALGXZ1 / UTY-APGXZ1

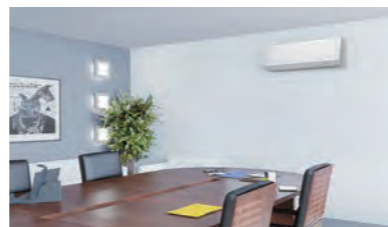

The Human sensor contributes to further energy savings.

Energy saving operation starts automatically by detecting the motion of a person. Two modes of save operation mode and stop mode can be selected.

* If you want to use the 'Occupancy sensor control' function, you need an setting device that can set the 'Occupancy sensor control' function. For example: Wired RC (Touch panel).

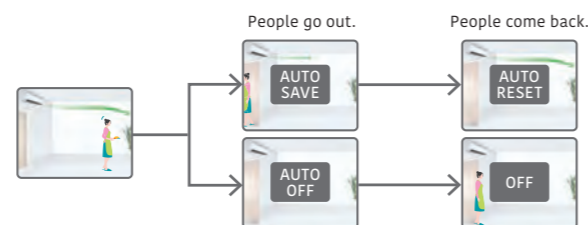

Model: ASYA004GCGH / ASYA007GCGH / ASYA009GCGH
ASYA012GCGH / ASYA014GCGH

[external EEV]
ASYE004GCEH / ASYE007GCEH / ASYE009GCEH
ASYE012GCEH / ASYE014GCEH



Specifications

Model name	ASYA004GCGH	ASYA007GCGH	ASYA009GCGH	ASYA012GCGH	ASYA014GCGH	ASYE004GCEH	ASYE007GCEH	ASYE009GCEH	ASYE012GCEH	ASYE014GCEH	
Power source	Single phase, ~230 V, 50 Hz					Single phase, ~230 V, 50 Hz					
Capacity	Cooling	1.1	2.2	2.8	3.6	4.0	1.1	2.2	2.8	3.6	4.0
	Heating	1.3	2.8	3.2	4.0	4.5	1.3	2.8	3.2	4.0	4.5
Input power		12	19	20	25	36	12	19	34	25	36
		450	550	610	690	800	450	550	610	690	800
Airflow rate	High	430	510	560	610	740	430	510	560	610	740
	Med-High	400	470	510	560	680	400	470	510	560	680
	Med	380	410	440	530	610	380	410	440	530	610
	Med-Low	360	360	360	470	550	360	360	360	470	550
	Low	310	310	310	330	330	310	310	310	330	330
	Quiet	31	34	37	40	44	31	35	43	40	44
Sound pressure level	High	30	32	35	37	42	30	32	38	37	42
	Med-High	28	30	32	35	40	28	30	34	35	40
	Med	27	28	29	33	37	27	27	29	33	37
	Med-Low	26	26	26	30	34	26	24	24	30	34
	Low	22	22	22	24	24	22	22	22	24	24
	Quiet										
Net Dimensions (H x W x D)	mm	268 x 840 x 203					268 x 840 x 203				
Weight	kg	8.0	8.5	8.5	8.5	8.5	8.0	8.5	8.5	8.5	8.5
Connection pipe diameter	Liquid (Flare)	6.35	6.35	6.35	6.35	6.35	6.35	6.35	6.35	6.35	6.35
	Gas (Flare)	9.52	9.52	9.52	12.70	12.70	9.52	9.52	9.52	12.70	12.70
Drain Hose Diameter (I.D./O.D.)		13.8/15.8 to16.7					13.8/15.8 to16.7				
EV kit (optional)		-					UTR-EV09XB		UTR-EV14XB		

Note: Specifications are subject to the following conditions:
Cooling: Indoor temperature of 27°CDB/19°CWB, and outdoor temperature of 35°CDB/24°CWB.
Heating: Indoor temperature of 20°CDB/(15°CWB), and outdoor temperature of 7°CDB/6°CWB.
Pipe length: 7.5 m; Height difference between outdoor unit and indoor unit: 0 m. Voltage: 230 [V]
When connecting ASY*004G**H, ASY*007G**H, ASY*009G**H to an outdoor unit other than the outdoor unit of the J-IVL Series, the gas pipe diameter should be Ø12.70 mm.

Optional parts

External power supply unit: UTZ-GXXA, UTZ-GXXC* Remote sensor kit: UTY-XSZXZ1 WLAN adapter: UTY-TFSXZ1, UTY-TFSXJ3, FG-AC-WIF1Z1
Silver Ion Filter: UTR-FA16-5

*For more details, please refer to the chapter "Optional parts".

Dimensions

(Unit: mm)

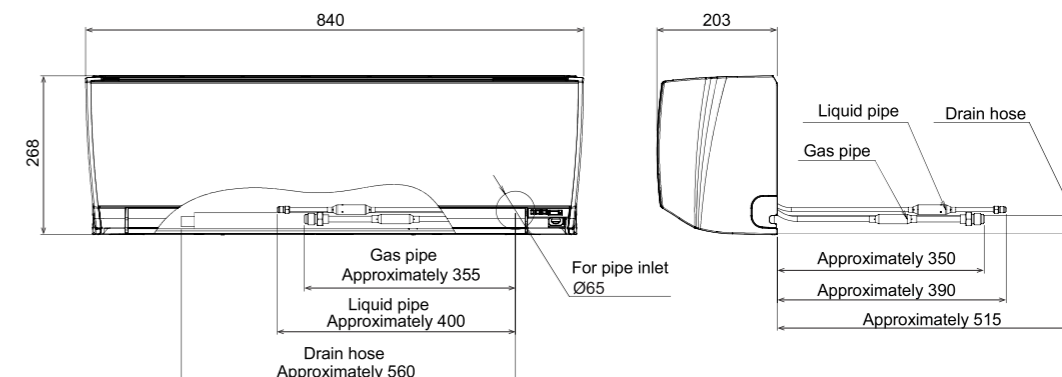

Wall-mounted type



Powerful & Comfort airflow

Powerful Airflow

(ASYA030GTEH)

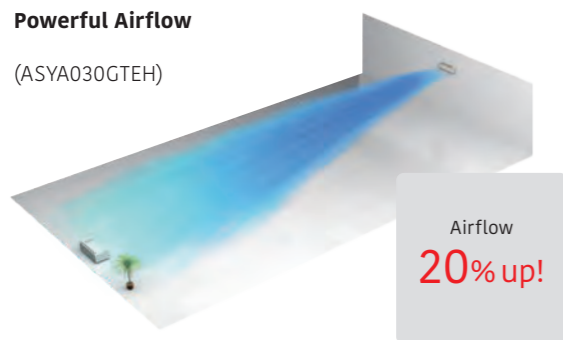

Power diffuser

(ASYA18/24GBCH)

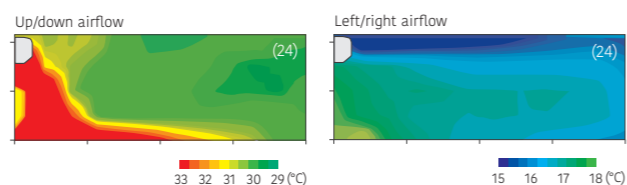

The Human sensor contributes to further energy savings (ASYA030/034GTEH only)

Energy saving operation starts automatically by detecting the motion of a person. Two modes of save operation mode and stop mode can be selected.

* If you want to use the Human sensor control' function, you need an setting device that can set the Human sensor control' function. For example: Wired RC (Touch panel).

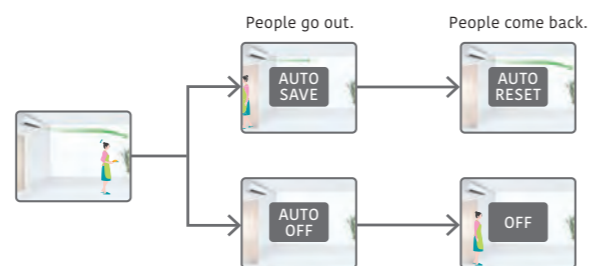

6-step fan speed control for quiet operation

The airflow pattern achieves significant noise reduction. A 6-step sound level setting allows for multiple-step silent operations.

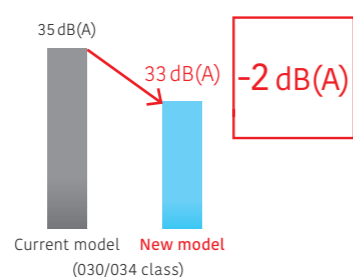

- 6-Step Speed
- High
- Med-High
- Med
- Med-Low
- Low
- Quiet

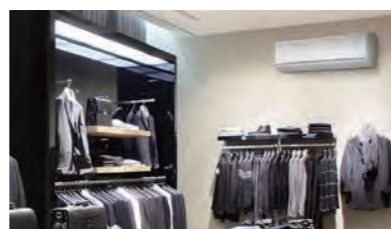

* Remote controller is compatible with the following:
 UTY-RVRY / UTY-LNVY / UTY-RNRZ5 / UTY-RLRY / UTY-RSRY / UTY-RHRY / UTY-DCGYZ2 / UTY-ALGXZ1 / UTY-APGXZ1

Model: ASYA18GBCH / ASYA24GBCH
 ASYA030GTEH / ASYA034GTEH



ASYA18/24GBCH



ASYA030/034GTEH

Specifications

Model name		ASYA18GBCH	ASYA24GBCH	ASYA030GTEH	ASYA034GTEH
Power source		Single phase, ~230 V, 50 Hz			
Capacity	Cooling	5.6	7.1	9.0	10.0
	Heating	6.3	8.0	10.0	11.2
Input power		32	60	74	103
Airflow rate	High	840	1,100	1,440	1,620/1,520
	Med-High	-	-	1,200	1,300
	Med	770	910	1,050	1,120
	Med-Low	-	-	940	980
	Low	690	730	890	890
	Quiet	-	-	700	700
Sound pressure level	High	41	48	53	55/54
	Med-High	-	-	49	51
	Med	39	43	45	47
	Med-Low	-	-	42	43
	Low	35	35	39	39
	Quiet	-	-	33	33
Net Dimensions (H × W × D)		mm 320 × 998 × 238	320 × 998 × 238	340 × 1,150 × 280	340 × 1,150 × 280
Weight		kg 15	15	18	18
Connection pipe diameter	Liquid (Flare)	6.35	9.52	9.52	9.52
	Gas (Flare)	12.70	15.88	15.88	15.88
Drain Hose Diameter (I.D./O.D.)		12/16		13.8/15.8 to16.7	

Note: Specifications are subject to the following conditions:
 Cooling: Indoor temperature of 27°CDB/19°CWB, and outdoor temperature of 35°CDB/24°CWB.
 Heating: Indoor temperature of 20°CDB/(15°CWB), and outdoor temperature of 7°CDB/6°CWB.
 Pipe length: 7.5 m; Height difference between outdoor unit and indoor unit: 0 m. Voltage: 230 [V].
 When connecting ASYA18GBCH to an outdoor unit other than the outdoor unit of the J-IVL Series, the pipe diameter should be Ø9.52/Ø15.88 mm (Liquid/Gas).

Optional parts

*For more details, please refer to the chapter "Optional parts".

External power supply unit: UTY-GXXA (030/034), UTY-GXXC* (030/034) WLAN adapter: UTY-TFSXJ3 (030/034), UTY-TFSXZ1 (030/034) Silver Ion Filter: UTR-FA13-3
 Remote sensor kit: UTY-XSZXZ1 FG-RC-WIF1Z2 (18/24), FG-AC-WIF1Z1 (030/034)

Dimensions

(Unit: mm)

Models: ASYA18/ASYA24

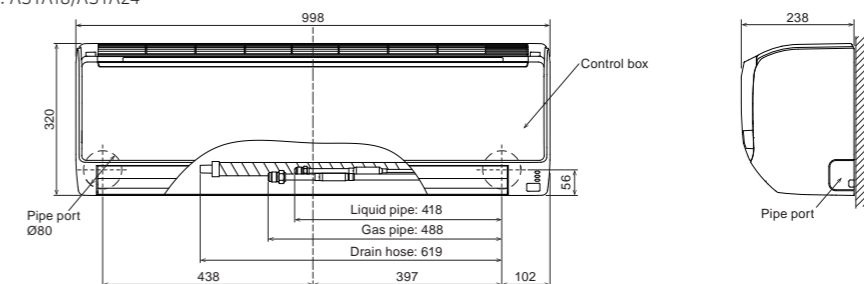

Models: ASYA030/ASYA034

