



Light Commercial & Residential MULTI-SPLIT

- M-002 Multi-split Overview
- M-004 Multi-split Outdoor Units Lineup
- M-006 2-unit to 5-unit Multi-split Connectable Indoor Units
- M-008 6-unit Multi-split Connectable Indoor Units
- M-010 Simultaneous Multi-split Connectable Indoor Units
- M-044 Feature Summary



Refrigerant type R32 models

- M-012 2-unit to 5-unit Multi-split
- M-018 Simultaneous Multi-split Twin/Triple

- M-022 2-unit to 5-unit Multi-split Indoor Units Specifications

- M-028 2-unit to 5-unit Multi-split Combination Table



Refrigerant type R410A models

- M-016 6-unit Multi-split
- M-020 Simultaneous Multi-split Twin/Triple/Double Twin

- M-026 6-unit Multi-split Indoor Units Specifications

- M-038 6-unit Multi-split Combination Table



A single outdoor unit drives multiple indoor units, offering greater flexibility in system configuration.

If you wish to keep an entire floor or two or more rooms comfortable, we recommend you choose a multi-split air conditioning system with a single outdoor unit. Choose one that meets your air conditioning requirements from the variety of models we offer. You can mix and match indoor and outdoor units as you wish to build the system that best suits your needs.

Multi-split Overview

Multi-split's space-saving outdoor unit allows for connections of up to eight indoor units for multiple rooms. Added to the lineup are models compatible with the new R32 refrigerant, offering environmentally friendly comfort in homes, offices, stores, and various other settings.



3-unit, 4-unit, 5-unit Multi-split Types



2-unit Multi-split



2-unit to 6-unit Multi-split

Recommended for residences, offices, and other situations where multiple rooms require air conditioning. Each of the 2 to 6 connected indoor units can also be operated individually. Operation control, time scheduling for each room, and energy-saving options can be set on both individual and central remote controllers. The outdoor unit is designed to save space and is flexible enough to be installed on a balcony or underneath a waist-high window.

6-unit Multi-split



Twin / Triple



Twin / Triple / Double Twin



Simultaneous Multi-split Type

Suitable for a small building, the entrance hall of a small office, meeting rooms, educational facilities, and other roomy areas where multiple indoor units need to be operated simultaneously. Up to 4 indoor units can be operated simultaneously, making the system perfect for air conditioning not only offices with large spaces, but also spaces with atypical layouts.

Multi-split Outdoor Units Lineup



FUJITSU GENERAL (Euro) GmbH participates in the ECP program for AC. Check ongoing validity of certificate: www.eurovent-certification.com
*Models so marked are not ECC certified.

		Class	14	18	18	24	30	36	45		54	72	90
		Cooling rated capacity (kW)	4.0	5.0	5.4	6.8	8.0	10.0	12.5	14.0	14.0	19.0	22.0
2-unit, 3-unit, 4-unit, 5-unit Multi-split	2-unit Multi-split Up to 2 units		AOEG14KBCA2	AOEG18KBCA2									
	3-unit Multi-split Up to 3 units				AOEG18KBCA3	AOEG24KBCA3							
	4-unit Multi-split Up to 4 units						AOEG30KBT4						
	5-unit Multi-split Up to 5 units							AOEG36KBT5*1					
6-unit Multi-split	6-unit Multi-split Up to 6 units								AOYG45LBLA6*				
Simultaneous Multi-split	Twin Single-phase							AOEG36KBTB	AOEG45KBTB				
	Twin 3-phase							AOEG36KRTA	AOEG45KRTA				
	Twin/Triple Single-phase										AOEG54KBTB		
	Twin/Triple 3-phase										AOEG54KRTA		
	Twin/Triple/Double Twin 3-phase											AOYG72LRLA	AOYG90LRLA

Notes: **1. 2-unit Multi-split:** Connectable indoor units are 2 units.
AOEG14KBCA2: Total capacity of indoor units connected must be between 4.0 kW and 6.0 kW.
AOEG18KBCA2: Total capacity of indoor units connected must be between 4.0 kW and 7.5 kW.
2. 3-unit Multi-split: Connectable indoor units are 2 to 3 units.
AOEG18KBCA3: Total capacity of indoor units connected must be between 4.0 kW and 8.5 kW.
AOEG24KBCA3: Total capacity of indoor units connected must be between 4.0 kW and 10.5 kW.

3. 4-unit Multi-split: Connectable indoor units are 2 to 4 units.
AOEG30KBT4: Total capacity of indoor units connected must be between 7.5 kW and 14.0 kW.
4. 5-unit Multi-split: Connectable indoor units are 2 to 5 units.
AOEG36KBT5: Total capacity of indoor units connected must be between 7.5 kW and 15.5 kW.

5. 6-unit Multi-split: Connectable indoor units are 2 to 6 units.
AOYG45LBLA6: Total capacity of indoor units connected must be between 9.5 kW and 18.0 kW.

Cooling rated capacity: *1: 9.5 kW

2-unit to 5-unit Multi-split Connectable Indoor Units



Type	2-unit		3-unit		4-unit	5-unit	
Model name	AOEG14KBCA2	AOEG18KBCA2	AOEG18KBCA3	AOEG24KBCA3	AOEG30KBT44	AOEG36KBT45	
Multi-split Type Outdoor Unit							
Capacity (kW)	Cooling	4.0	5.0	5.4	6.8	8.0	9.5
	Heating	4.4	5.6	6.8	8.0	9.6	10.6

Indoor Unit	BTU	kW Class	2-unit	3-unit	4-unit	5-unit
 ASEH07/09/12/14KGTG ASYG07/09/12/14KGTG	7,000	2.0	●	●	●	●
	9,000	2.5	●	●	●	●
	12,000	3.5	●	●	●	●
	14,000	4.0	—	●	●	●
 ASEG07/09/12/14KETG ASEG07/09/12/14KETG-B ASYG07/09/12/14KETE ASYG07/09/12/14KETE-B	7,000	2.0	●	●	●	●
	9,000	2.5	●	●	●	●
	12,000	3.5	●	●	●	●
	14,000	4.0	—	●	●	●
 ASEH07/09/12/14KMG ASYG07/09/12/14KMG-B	7,000	2.0	●	●	●	●
	9,000	2.5	●	●	●	●
	12,000	3.5	●	●	●	●
	14,000	4.0	—	●	●	●
 ASEH05/07/09/12KNCA	5,000	1.5	●*	●*	●*	●*
	7,000	2.0	●	●	●	●
	9,000	2.5	●	●	●	●
	12,000	3.5	●	●	●	●
 ASEG18/22/24KMTE	18,000	5.0	—	—	●	●
	22,000	6.0	—	—	—	●
	24,000	7.0	—	—	—	●
 ASEG09/12/14KVCA	9,000	2.5	●	●	●	●
	12,000	3.5	●	●	●	●
	14,000	4.0	—	●	●	●
 AUXG07/09/12/14/18/22KVLA	7,000	2.0	●	●	●	●
	9,000	2.5	●	●	●	●
	12,000	3.5	●	●	●	●
	14,000	4.0	—	●	●	●
	18,000	5.0	—	—	●	●
	22,000	6.0	—	—	—	●

*Please consult your dealer for compatible outdoor units with 5kW models.



Type	2-unit		3-unit		4-unit	5-unit	
Model name	AOEG14KBCA2	AOEG18KBCA2	AOEG18KBCA3	AOEG24KBCA3	AOEG30KBT44	AOEG36KBT45	
Multi-split Type Outdoor Unit							
Capacity (kW)	Cooling	4.0	5.0	5.4	6.8	8.0	9.5
	Heating	4.4	5.6	6.8	8.0	9.6	10.6

Indoor Unit	BTU	kW Class	2-unit	3-unit	4-unit	5-unit
 ARXG07/09/12/14/18KSLAP	7,000	2.0	●	●	●	●
	9,000	2.5	●	●	●	●
	12,000	3.5	●	●	●	●
	14,000	4.0	—	●	●	●
 ARXG07/09/12/14/18KLLAP	7,000	2.0	●	●	●	●
	9,000	2.5	●	●	●	●
	12,000	3.5	●	●	●	●
	14,000	4.0	—	●	●	●
 ARXH12/14/18/22KMTAP	12,000	3.5	●	●	●	●
	14,000	4.0	—	●	●	●
	18,000	5.0	—	—	●	●
	22,000	6.0	—	—	—	●
 ARXG22KMLB	22,000	6.0	—	—	—	●
 ABEG18/22KRTA	18,000	5.0	—	—	●	●
	22,000	6.0	—	—	—	●

6-unit Multi-split Connectable Indoor Units



Type	6-unit	
Model name	AOYG45LBLA6	
Multi-split Type Outdoor Unit		
Capacity (kW)	Cooling	12.5
	Heating	13.5

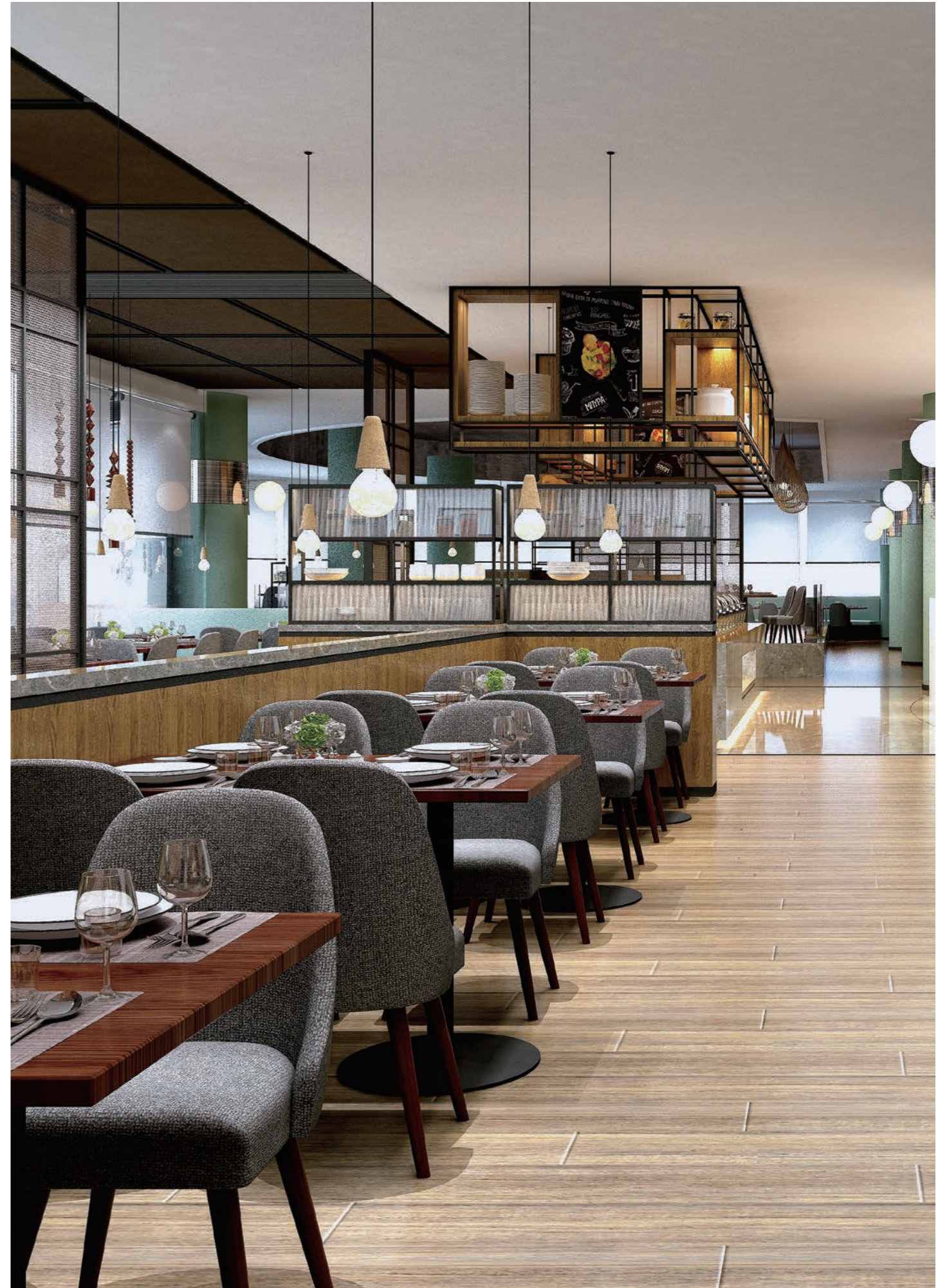

Indoor Unit	BTU	kW Class	
 ASYG07/09/12/14LMCE	7,000	2.0	●
	9,000	2.5	●
 ASYG07/09/12/14LUCA	12,000	3.5	●
	14,000	4.0	●
 ASYG18/24LF	18,000	5.0	●
	24,000	7.0	●
 AGYG09/12/14LV	9,000	2.5	●
	12,000	3.5	●
	14,000	4.0	●
 AUYG07/09/12/14/18LV	7,000	2.0	●
	9,000	2.5	●
	12,000	3.5	●
	14,000	4.0	●
 ABYG14LVTA ABYG18LVTB	14,000	4.0	●
	18,000	5.0	●
 ARYG07/09/12/14/18SLAP	7,000	2.0	●
	9,000	2.5	●
	12,000	3.5	●
	14,000	4.0	●
 ARYG07/09/12/14/18LL	18,000	5.0	●
	7,000	2.0	●
	9,000	2.5	●
	12,000	3.5	●
 ARYG07/09/12/14/18LL	14,000	4.0	●
	18,000	5.0	●



Simultaneous Multi-split Connectable Indoor Units





Type	4HP		5HP		6HP	
Model name	AOEG36KBTB	AOEG36KRTA	AOEG45KBTB	AOEG45KRTA	AOEG54KBTB	AOEG54KRTA
Simultaneous Multi-split Type Outdoor Unit						
Capacity (kW)	Cooling	9.5	12.1	13.4	13.4	13.4
	Heating	10.8	13.5	15.5	15.5	15.5

Indoor Unit	BTU	kW Class	Twin			Triple
			● × 2	● × 2	● × 2	● × 3
 AUXG18/22/24KVL A	18,000	5.0	● × 2	—	—	● × 3
	22,000	6.5	—	● × 2	—	—
	24,000	7.0	—	—	● × 2	—
 ARXG18KLLAP	18,000	5.0	● × 2	—	—	● × 3
	22,000	6.5	—	● × 2	—	—
	24,000	7.0	—	—	● × 2	—
 ARXG22KMLB ARXG24KMLA	22,000	6.5	—	● × 2	—	—
	24,000	7.0	—	—	● × 2	—
	Separation tube			UTP-SX236A (18/22/24)		

Note : Please be aware that 2-wired group control is not possible with Simultaneous Multi-split.



Type	8HP	10HP
Model name	AOYG72LRLA	
Simultaneous Multi-split Outdoor Unit		
Capacity (kW)	Cooling	19.0
	Heating	22.4

Indoor Unit	BTU	kW Class	Twin	Triple	Double Twin	Twin	Triple	Double Twin
			—	● × 3	● × 4	—	● × 3	—
 AUYG18/22/24LV	18,000	5.0	—	—	● × 4	—	—	—
	22,000	6.5	—	—	—	—	—	● × 4
	24,000	7.0	—	● × 3	—	—	—	—
 AUYG30/36/45LR	30,000	8.8	—	—	—	—	● × 3	—
	36,000	10.6	● × 2	—	—	—	—	—
	45,000	12.5	—	—	—	● × 2	—	—
 ARYG18LLTB	18,000	5.0	—	—	● × 4	—	—	—
	22,000	6.5	—	—	—	—	—	● × 4
	24,000	7.0	—	● × 3	—	—	—	—
 ARYG22/24/ 30/36/45LM	30,000	8.8	—	—	—	—	● × 3	—
	36,000	10.6	● × 2	—	—	—	—	—
	45,000	12.5	—	—	—	● × 2	—	—
	Separation tube			UTP-SX272A × 1	UTP-SX372A × 1	UTP-SX272A × 1, UTP-SX236A × 2	UTP-SX272A × 1	UTP-SX372A × 1
 ABYG18/22/24LV	18,000	5.0	—	—	● × 4	—	—	—
	22,000	6.5	—	—	—	—	—	● × 4
	24,000	7.0	—	● × 3	—	—	—	—
 ABYG30/36/45LR	30,000	8.8	—	—	—	—	● × 3	—
	36,000	10.6	● × 2	—	—	—	—	—
	45,000	12.5	—	—	—	● × 2	—	—

2-unit,
3-unit,
4-unit,
5-unit,
Multi-split



High energy saving

With the adoption of a high-efficiency DC twin-rotary compressor, all models achieved an energy efficiency scale of A+++ for cooling and A++ for heating.

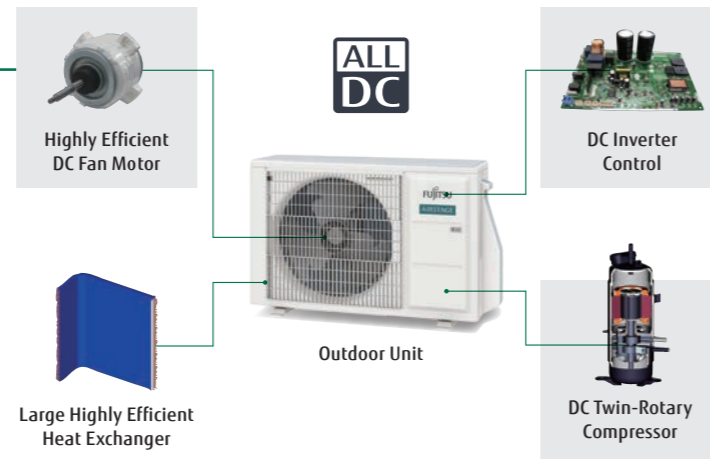

R32 refrigerant model

In addition to its high energy efficiency, the R32 refrigerant has a larger volumetric capacity than the R410A refrigerant, which means the R32 refrigerant models require less refrigerant charge than the R410A models.

	Pre-charge refrigerant amount (kg)	
	R32	R410A
2-unit 14 class	0.9	1.25
2-unit 18 class	1.02	1.30
3-unit 18 class	1.8	2.2
3-unit 24 class	1.8	2.2
4-unit 30 class	2.2	3.3
5-unit 36 class	2.5	4.0

Quiet operation

The sound power level is reduced by up to 7 dB compared to the current R410 models.

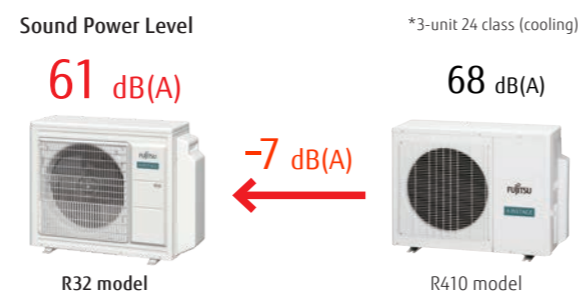

Space-saving installation

Multiple indoor units can be connected to 1 outdoor unit by long piping as well. Unlike a single type, the outdoor unit can be installed in the most space-saving location.



Compact design

Unlike a single type, the outdoor unit can be installed in the most space-saving location.

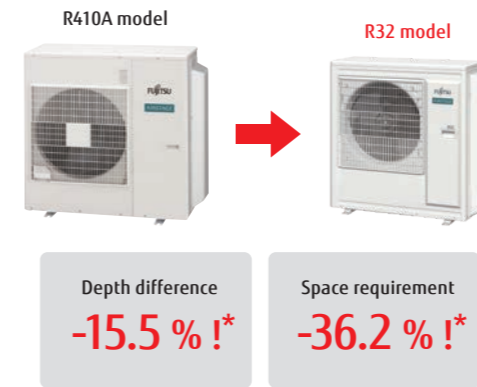

*: Compared with current 5-unit multi models

Easy evacuation

All connected pipes and indoor units can be evacuated quickly via our centralized valve method. Requires evacuation only once.

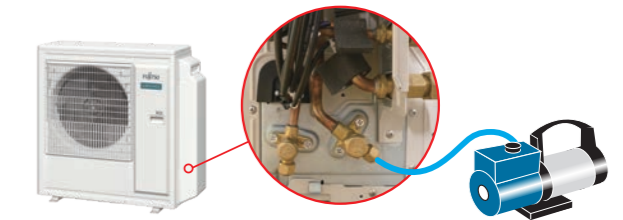

Wide range of indoor units with various models

We offer 41 models in 5 types in a capacity range from 2.0 kW to 6.0 kW. Wide range of requirements can be realized from private homes through to large shops and hotels

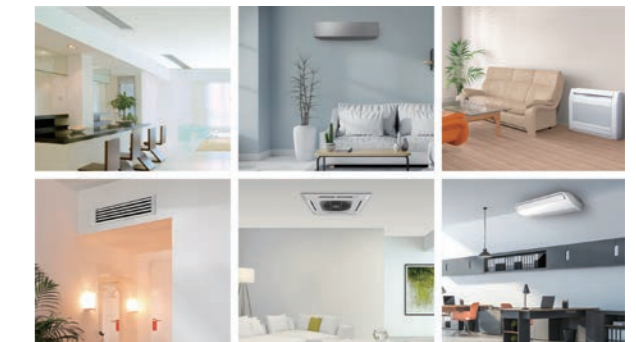

Models equipped with the New R32 Refrigerant

Wall-mounted type with sophisticated design



Middle and small capacity models are available. This makes installation easier in small spaces.



2-unit: A0EG14KBCA2 / A0EG18KBCA2
 3-unit: A0EG18KBCA3 / A0EG24KBCA3
 4-unit: A0EG30KBT4
 5-unit: A0EG36KBT5



Specifications (2-unit)

Model name		A0EG14KBCA2		A0EG18KBCA2	
Power Source					
Single phase, ~230 V, 50 Hz					
Rated Capacity	Cooling	Rated Min.-Max.	kW	4.0	5.0
	Heating	Rated Min.-Max.		1.4-4.6	1.7-5.8
EER	Cooling	Rated	W/W	4.4	5.6
	Heating	Rated		1.1-5.5	1.8-6.6
COP	Cooling	Rated	W/W	4.12	4.03
	Heating	Rated		4.63	4.59
Sound Pressure Level (High)	Cooling	Rated	dB(A)	47	47
	Heating	Rated		49	50
Sound Power Level (High)	Cooling	Rated	dB(A)	60	60
	Heating	Rated		62	62
Airflow Rate	Cooling/Heating	m ³ /h	1,670/1,670	1,960/2,020	
Net Dimensions H × W × D		mm	542 × 799 × 290	632 × 799 × 290	
Weight		kg	33	37	
Connection Pipe Diameter	Liquid	mm	6.35 × 2	6.35 × 2	
	Gas	mm	9.52 × 2	9.52 × 2	
Max. Pipe Length		Total/Each	30/20	30/20	
Max. Height Difference	Between Outdoor Unit and Each Indoor Unit	m	15	15	
	Between Indoor Units	m	10	10	
Operating Range	Cooling	°CDB	-10 to 46	-10 to 46	
	Heating	°CDB	-15 to 24	-15 to 24	
Refrigerant	Type (Global Warming Potential)		R32 (675)	R32 (675)	
	Charge	kg (CO ₂ eq-T)	0.9 (0.608)	1.02 (0.689)	

Specifications (3-unit)

Model name		A0EG18KBCA3		A0EG24KBCA3	
Power Source					
Single phase, ~230 V, 50 Hz					
Rated Capacity	Cooling	Rated Min.-Max.	kW	5.4	6.8
	Heating	Rated Min.-Max.		1.8-7.0	1.8-8.5
EER	Cooling	Rated	W/W	6.8	8.0
	Heating	Rated		2.0-8.0	2.0-9.2
COP	Cooling	Rated	W/W	4.78	3.90
	Heating	Rated		4.89	4.40
Sound Pressure Level (High)	Cooling	Rated	dB(A)	46	48
	Heating	Rated		49	53
Sound Power Level (High)	Cooling	Rated	dB(A)	59	61
	Heating	Rated		61	67
Airflow Rate	Cooling/Heating	m ³ /h	2,220/2,160	2,270/2,730	
Net Dimensions H × W × D		mm	716 × 820 × 315	716 × 820 × 315	
Weight		kg	46	46	
Connection Pipe Diameter	Liquid	mm	6.35 × 3	6.35 × 3	
	Gas	mm	9.52 × 3	9.52 × 2, 12.70 × 1 adapter [12.70 → 9.52] × 1	
Max. Pipe Length		Total/Each	50/25	50/25	
Max. Height Difference	Between Outdoor Unit and Each Indoor Unit	m	15	15	
	Between Indoor Units	m	10	10	
Operating Range	Cooling	°CDB	-10 to 46	-10 to 46	
	Heating	°CDB	-15 to 24	-15 to 24	
Refrigerant	Type (Global Warming Potential)		R32 (675)	R32 (675)	
	Charge	kg (CO ₂ eq-T)	1.8 (1.215)	1.8 (1.215)	

Specifications (4-unit, 5-unit)

Model name		A0EG30KBT4		A0EG36KBT5	
Power Source					
Single phase, ~230 V, 50 Hz					
Rated Capacity	Cooling	Rated Min.-Max.	kW	8.0	9.5
	Heating	Rated Min.-Max.		2.4-10.1	3.0-11.0
EER	Cooling	Rated	W/W	9.6	10.6
	Heating	Rated		3.0-11.2	3.5-12.0
COP	Cooling	Rated	W/W	3.90	3.80
	Heating	Rated		4.55	4.50
Sound Pressure Level (High)	Cooling	Rated	dB(A)	50	52
	Heating	Rated		54	55
Sound Power Level (High)	Cooling	Rated	dB(A)	63	65
	Heating	Rated		66	68
Airflow Rate	Cooling/Heating	m ³ /h	2,400/2,950	2,450/2,900	
Net Dimensions H × W × D		mm	884 × 820 × 315	884 × 820 × 315	
Weight		kg	55	59	
Connection Pipe Diameter	Liquid	mm	6.35 × 4	6.35 × 5	
	Gas	mm	9.52 × 2, 12.70 × 2 adapter [12.70 → 9.52] × 2	9.52 × 3, 12.70 × 2 adapter [12.70 → 9.52] × 2 adapter [9.52 → 12.70] × 1	
Max. Pipe Length*		Total/Each	70/25	75/25	
Max. Height Difference	Between Outdoor Unit and Each Indoor Unit	m	15	15	
	Between Indoor Units	m	10	10	
Operating Range	Cooling	°CDB	-10 to 46	-10 to 46	
	Heating	°CDB	-15 to 24	-15 to 24	
Refrigerant	Type (Global Warming Potential)		R32 (675)	R32 (675)	
	Charge	kg (CO ₂ eq-T)	2.2 (1.485)	2.5 (1.688)	

*Length not applicable when floor units are connected. For details, refer to the installation manual.

Dimensions

(Unit: mm)

2-unit: A0EG14KBCA2

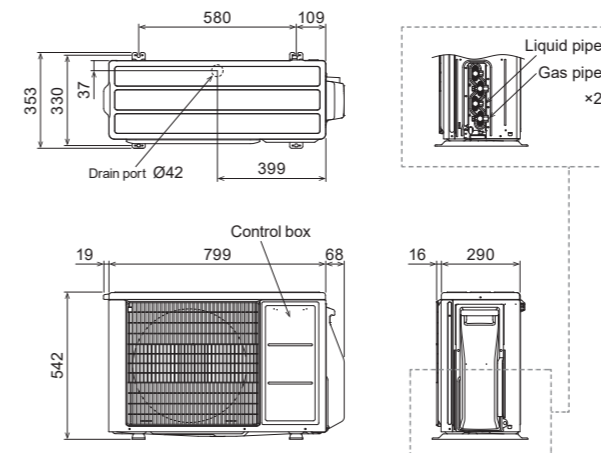

2-unit: A0EG18KBCA2

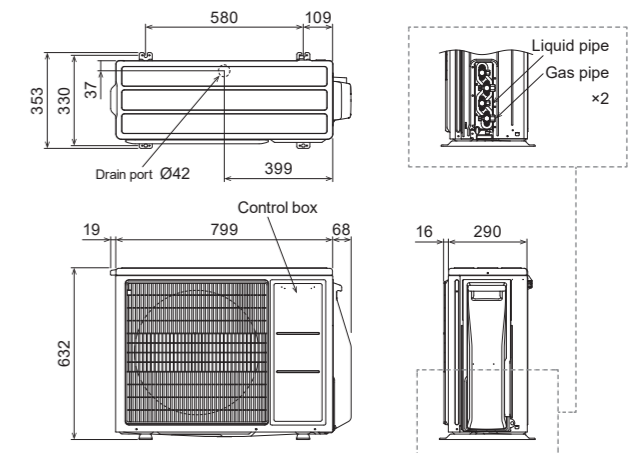

3-unit: A0EG18KBCA3 / A0EG24KBCA3

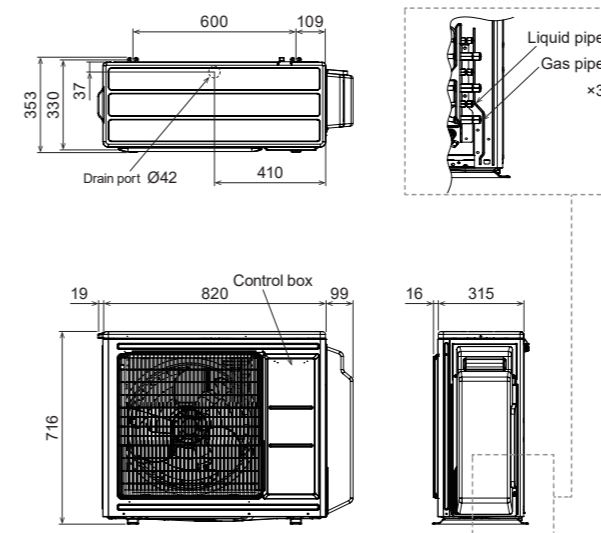

4-unit: A0EG30KBT4
5-unit: A0EG36KBT5

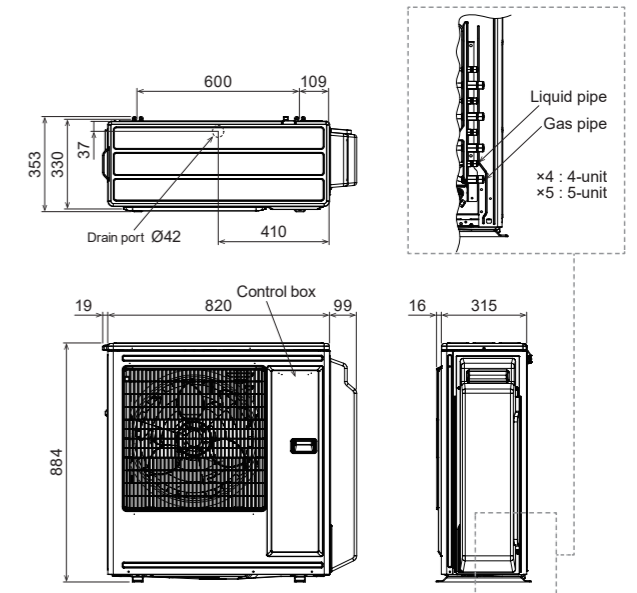

6-unit Multi-split



6-unit: AOYG45LBLA6



Specifications

Model name			AOYG45LBLA6	
Power Source			Single phase, ~230 V, 50 Hz	
Rated Capacity	Cooling	Rated	kW	12.5
		Min.-Max.		3.5-14.0
Rated Capacity	Heating	Rated	kW	13.5
		Min.-Max.		3.5-16.0
EER	Cooling		W/W	3.50
COP	Heating			4.00
Sound Pressure Level (High)	Cooling		dB(A)	53
	Heating			55
Sound Power Level (High)	Cooling		dB(A)	-
	Heating			-
Airflow Rate	Cooling/Heating		m ³ /h	4,200/4,200
Net Dimensions H × W × D			mm	998 × 970 × 370
Weight			kg	94
Connection Pipe Diameter	Liquid		mm	6.35 × 6
	Gas			9.52 × 4, 12.70 × 2
Max. Pipe Length	Total/Each		m	80/25
	Between Outdoor Unit and Each Indoor Unit.			15
Max. Height Difference	Between Indoor Units.		m	10
Operating Range	Cooling		°CDB	-10 to 46
	Heating			-15 to 24
Refrigerant	Type (Global Warming Potential)		kg (CO ₂ eq-T)	R410A (2,088)
	Charge			4.00 (8.352)

A wide variety of models to choose from

We offer 26 models in 5 types in a capacity range from 2.0 kW to 7.0 kW. Wide range of requirements can be realized from private homes through to large shops and hotels.



Compact design

Multiple indoor units can be connected to 1 outdoor unit by long piping as well. Unlike a single type, the outdoor unit can be installed in the most space-saving location.



Easy installation

All connected pipes and indoor units can be evacuated quickly via our centralized valve method. Requires evacuation only once.

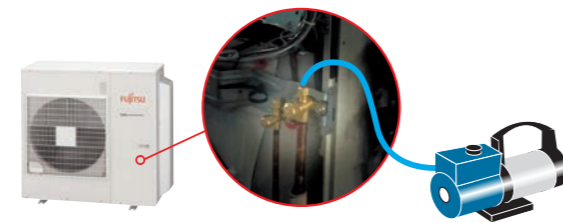

Central & Individual control

- Batched control of up to 6 indoor units. Unified setting of room temperature, airflow volume, and local control restrictions across units.
- Language can be selected from English, French, German, Greek, Italian, Portuguese, Russian, Spanish, or Turkish.
- Large backlit LED screen
- Large easy-to-see operation panel

Max. Controllable
1 multi-system

Max. Controllable
6 indoor units



Dimensions

(Unit: mm)

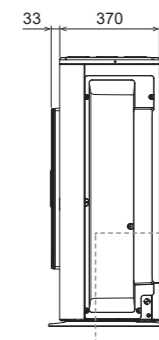
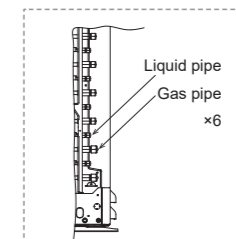
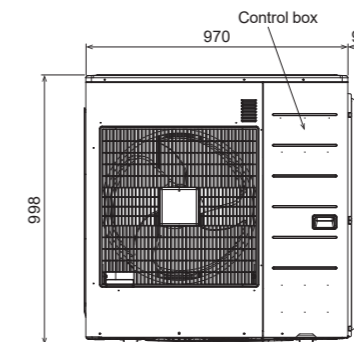
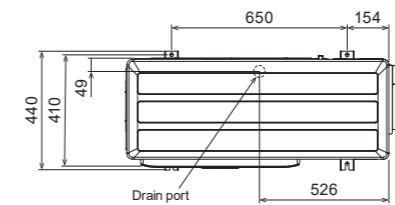

Simultaneous Multi-split Type

Twin / Triple



Meets a variety of installation needs from offices to commercial spaces, with up to 3 indoor units in the same room connected to an outdoor unit.

Select indoor units according to floor layout and heat load estimated by the number of people working in the room and the direction and intensity of sunlight entering the room. Perfect airflow distribution can be achieved for optimum comfort.

Installation according to floor layout

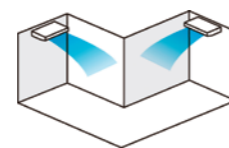

Installation according to lighting conditions

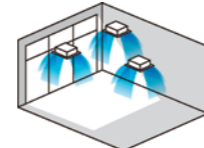

Design flexibility

Slim & Compact Design

The outdoor unit in this series is 22.7% shorter* than a twin-fan outdoor unit. The reduced height makes it easy to install in tight spaces.

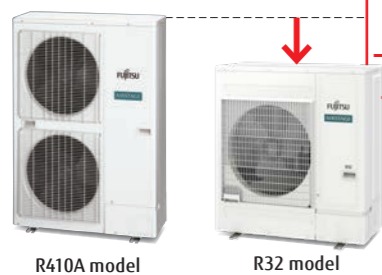

Height -22.7%*
 (*: Applicable to the 45,000- and 54,000-BTU models)

Flexible installation

Pipe length of up to 50 m and a height difference of up to 30 m can be accommodated. Multi-split systems can be installed in large residences and multi-story buildings.

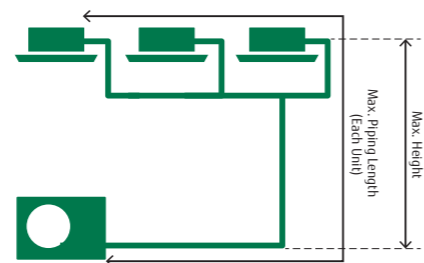

Max. Pipe Length (Each Unit): **50 m**
 Max. Height: **30 m**

New lineup of indoor units

The indoor units, available in 6 models of 3 types, can be selected according to room size and conditions.



Compact Cassette



Slim Duct



Duct

Note : Please be aware that 2-wired group control is not possible with Simultaneous Multi-split.

Model: AOEG36KBTB / AOEG45KBTB / AOEG54KBTB
 AOEG36KRTA [3-phase] / AOEG45KRTA [3-phase] / AOEG54KRTA [3-phase]



Specifications (Indoor units/Outdoor units)

Indoor Units Model name	Compact Cassette		
	AUXG18KVLA	AUXG22KVLA	AUXG24KVLA
Power Source	Single phase, ~230 V, 50 Hz		
Airflow Rate	Cooling Heating	H/M/L/Q H/M/L/Q	m ³ /h
Net Dimensions H × W × D	mm		
Weight	kg		
Cassette Grille	UTG-UFYF-W		

Indoor Units Model name	Duct		
	ARXG18KLLAP	ARXG22KMLB	ARXG24KMLA
Power Source	Single phase, ~230 V, 50 Hz		
Airflow Rate	Cooling Heating	H/M/L/Q H/M/L/Q	m ³ /h
Net Dimensions H × W × D	mm		
Weight	kg		

Outdoor Units Model name	AOEG36KBTB			AOEG45KBTB			AOEG54KBTB			
	AOEG36KRTA	AOEG45KRTA	AOEG54KRTA							
Capacity	Cooling Heating	kW			9.5 10.8	12.1 13.5	13.4 15.5	9.5 10.8	12.1 13.5	13.4 15.5
Power Source	Single phase, ~230 V, 50 Hz						3-phase, ~400 V, 50 Hz			
Pdesign	Cooling Heating (-10°C)	kW			9.5 8.7	- -	- -	9.5 8.7	- -	- -
SEER	Cooling	W/W			6.10	-	-	6.10	-	-
SCOP	Heating	W/W			4.00	-	-	4.00	-	-
Annual Energy Consumption	Cooling Heating	kWh/a			545 3,044	- -	- -	545 3,044	- -	- -
Energy Efficiency Class	Cooling Heating	A++ A+			- -	- -	- -	A++ A+	- -	- -
Sound Pressure Level (High)	Cooling Heating	dB(A)			55 55	57 57	57 59	55 55	57 57	57 59
Sound Power Level (High)	Cooling Heating	dB(A)			70 70	71 71	73 73	70 70	71 71	73 73
Airflow Rate	Cooling/Heating	m ³ /h			3,750/3,750	4,450/4,450	4,450/4,450	3,750/3,750	4,450/4,450	4,450/4,450
Net Dimensions H × W × D	mm			788 × 940 × 320	998 × 940 × 320	998 × 940 × 320	788 × 940 × 320	998 × 940 × 320	998 × 940 × 320	
Weight	kg			52	67	67	53	67	67	
Connection Pipe Diameter (Liquid/Gas)	mm			9.52/15.88	9.52/15.88	9.52/15.88	9.52/15.88	9.52/15.88	9.52/15.88	
Max. Pipe Length (Pre-Charge)	m			50 (30)	50 (30)	50 (30)	50 (30)	50 (30)	50 (30)	
Max. Height Difference	m			30	30	30	30	30	30	
Operating Range	Cooling Heating	°CDB			-15 to 46 -15 to 24	-15 to 46 -15 to 24	-15 to 46 -15 to 24	-15 to 46 -15 to 24	-15 to 46 -15 to 24	-15 to 46 -15 to 24
Refrigerant	Type (Global Warming Potential)	R32 (675)			R32 (675)	R32 (675)	R32 (675)	R32 (675)	R32 (675)	R32 (675)
Charge	kg (CO ₂ eq-T)	1.90 (1.283)			2.70 (1.823)	2.70 (1.823)	1.90 (1.283)	2.70 (1.823)	2.70 (1.823)	
Separation tube	UTP-SX236A (Twin)			UTP-SX236A (Twin)	UTP-SX236A (Twin)	UTP-SX236A (Twin)	UTP-SX236A (Twin)	UTP-SX236A (Twin)	UTP-SX236A (Twin)	UTP-SX236A (Twin) UTP-SX354A (Triple)

• Indoor units of different types and capacity cannot be connected.
 • The above specifications apply when used with a cassette type indoor unit.

Dimensions

(Unit: mm)

AOEG36KBTB / AOEG36KRTA

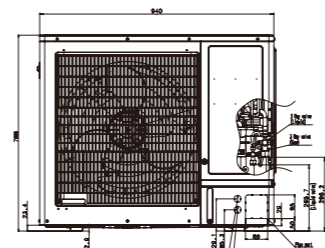
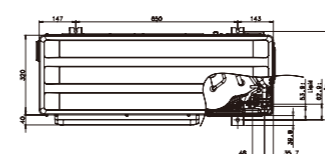

AOEG45KBTB / AOEG54KBTB AOEG45KRTA / AOEG54KRTA

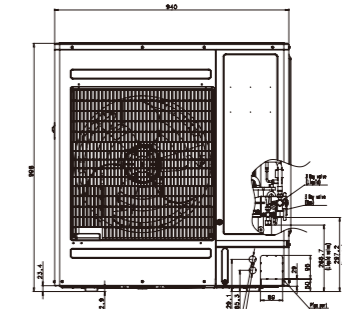
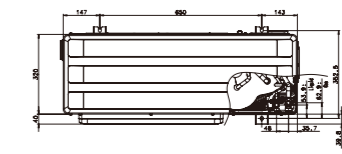

Simultaneous Multi-split Type

Twin / Triple / Double Twin



Meets a variety of installation needs from an open-plan office to a retail store, with up to 4 indoor units connected to an outdoor unit.

Select indoor units according to floor layout and heat load estimated by the number of people working in the room and the direction and intensity of sunlight entering the room. Perfect airflow distribution can be achieved for optimum comfort.

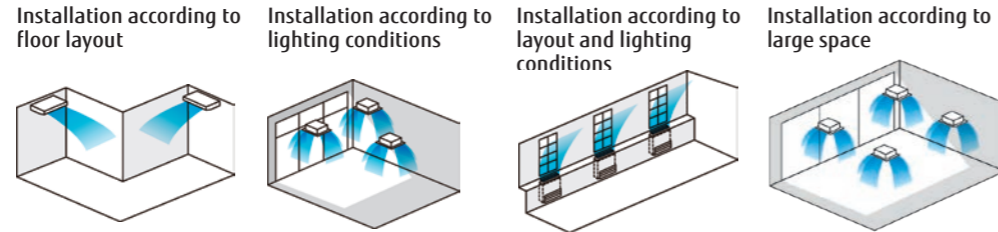

Simultaneous control

Up to 16 indoor units can be controlled simultaneously with a wired remote controller.

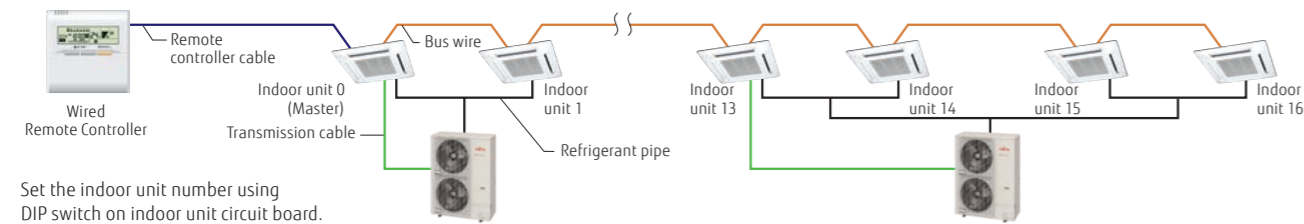

Set the indoor unit number using DIP switch on indoor unit circuit board.

*The following functions are not provided by a wireless remote controller: Timer operation, Sleep Timer operation, 10°C Heat operation

Indoor unit lineup

The indoor units, available in 18 models of 6 types, can be selected according to room size and conditions.

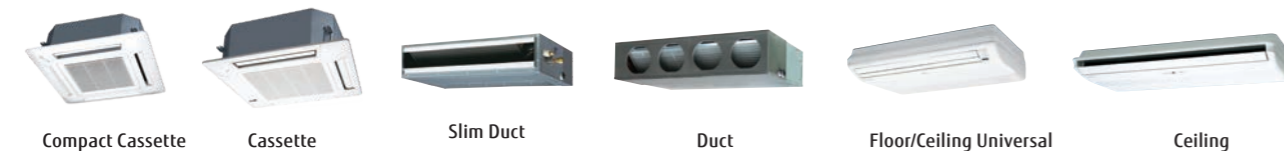

Model: AOYG72LRLA [3-phase] / AOYG90LRLA [3-phase]



Specifications (Indoor units/Outdoor units)

Indoor Units Model name		Compact Cassette, Cassette							
		AUYG18LVLB	AUYG22LVLA	AUYG24LVLA	AUYG30LRLE	AUYG36LRLE	AUYG45LRLA		
Power Source		Single phase, ~230 V, 50 Hz							
Airflow Rate	Cooling	H/M/L/Q	m ³ /h	750/610/520/410	930/830/600/450	930/830/600/450	1,600/1,400/1,270/1,150	1,800/1,400/1,270/1,150	1,900/1,640/1,460/1,250
	Heating	H/M/L/Q	m ³ /h	800/710/600/450	930/860/700/530	930/830/600/450	1,800/1,400/1,270/1,150	1,800/1,400/1,270/1,150	1,900/1,640/1,460/1,250
Net Dimensions H × W × D		mm		245 × 570 × 570	245 × 570 × 570	245 × 570 × 570	288 × 840 × 840	288 × 840 × 840	288 × 840 × 840
Weight		kg		15	16	16	26	26	26
Cassette Grille		UTG-UFYD-W						UTG-UGYA-W	

Indoor Units Model name		Duct							
		ARYG18LTLB	ARYG22LMLA	ARYG24LMLA	ARYG30LMLE	ARYG36LMLE	ARYG45LMLA		
Power Source		Single phase, ~230 V, 50 Hz							
Airflow Rate	Cooling	H/M/L/Q	m ³ /h	940/880/820/750	1,100/910/750/580	1,100/910/750/580	1,900/1,620/1,270/980	1,900/1,620/1,270/980	2,100/1,750/1,350/1,070
	Heating	H/M/L/Q	m ³ /h	940/880/820/750	1,100/910/750/580	1,100/910/750/580	2,100/1,620/1,270/980	2,100/1,620/1,270/980	2,100/1,750/1,350/1,070
Net Dimensions H × W × D		mm		198 × 900 × 620	270 × 1135 × 700	270 × 1135 × 700	270 × 1135 × 700	270 × 1135 × 700	270 × 1135 × 700
Weight		kg		23	38	40	40	40	40 (88)

Indoor Units Model name		Floor/Ceiling, Ceiling							
		ABYG18LVTB	ABYG22LVTA	ABYG24LVTA	ABYG30LRTE	ABYG36LRTE	ABYG45LRTA		
Power Source		Single phase, ~230 V, 50 Hz							
Airflow Rate	Cooling	H/M/L/Q	m ³ /h	780/700/560/500	980/820/680/540	980/820/680/540	1,660/1,500/1,200/1,000	1,900/1,500/1,200/1,000	2,100/1,700/1,400/1,100
	Heating	H/M/L/Q	m ³ /h	780/700/560/500	980/820/680/540	980/820/680/540	1,660/1,500/1,200/1,000	1,900/1,500/1,200/1,000	2,100/1,700/1,400/1,100
Net Dimensions H × W × D		mm		199 × 990 × 655	199 × 990 × 655	199 × 990 × 655	240 × 1660 × 700	240 × 1660 × 700	240 × 1660 × 700
Weight		kg		27	27	27	46	46	46

Outdoor Units Model name				AOYG72LRLA		AOYG90LRLA	
		Cooling	Heating	kW		kW	
Capacity				19.0		22.0	
				22.4		27.0	
Power Source		3-phase, ~400 V, 50 Hz					
Sound Pressure Level (High)		Cooling/Heating		dB(A)		55/57	
Airflow Rate		Cooling/Heating		m ³ /h		8,400/8,400	
Net Dimensions H × W × D		mm		1,428 × 1,080 × 480		1,428 × 1,080 × 480	
Weight		kg		163		172	
Connection Pipe Diameter (Liquid/Gas)		mm		12.7/25.4		12.7/25.4	
Max. Pipe Length (Pre-Charge)		m		100 (30)		100 (30)	
Max. Height Difference		m		30		30	
Operating Range		Cooling		°CDB		-15 to 46	
		Heating		°CDB		-20 to 24	
Refrigerant		Type (Global Warming Potential)		R410A (2,088)		R410A (2,088)	
		Charge		kg (CO2eq-T)		7.1 (14.825)	
Separation tube		UTP-SX272A × 1 (Twin)		UTP-SX372A × 1 (Triple)		UTP-SX272A × 1 (Twin)	
		UTP-SX236A × 2 (Double Twin)		UTP-SX272A × 1 (Twin)		UTP-SX372A × 1 (Triple)	
		UTP-SX254A × 2 (Double Twin)		UTP-SX272A × 1 (Twin)		UTP-SX372A × 1 (Triple)	

*: That specification is not fixed yet.

• Indoor units of different types and capacity cannot be connected.
• The above specifications apply when used with a cassette type indoor unit.

Dimensions

(Unit: mm)

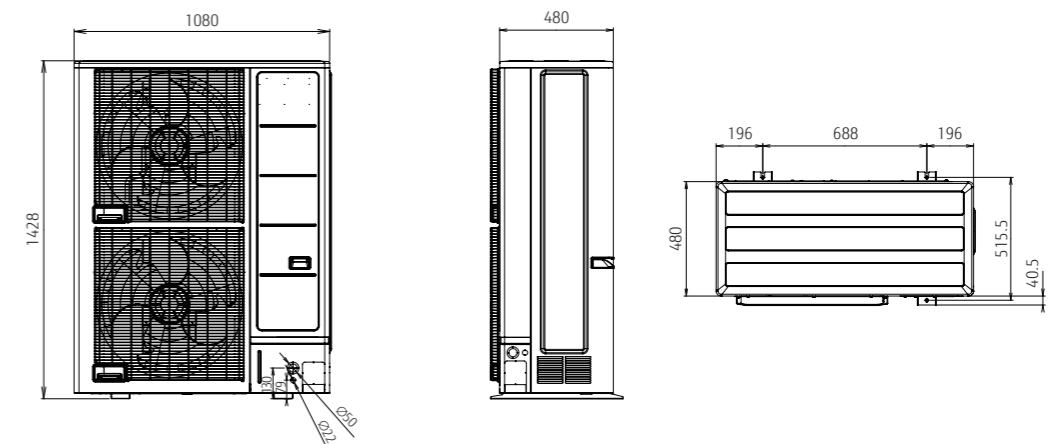

2-unit to 5-unit Multi-split Indoor Units Specifications



Wall-mounted type

Model name	Indoor unit		ASEH07KGTG ASYG07KGTE	ASEH09KGTG ASYG09KGTE	ASEH12KGTG ASYG12KGTE	ASEH14KGTG ASYG14KGTE
kW Class	kW		2.0	2.5	3.5	4.0
Power Source	Single phase, ~230 V, 50 Hz					
Sound Pressure Level	Cooling	H/M/L/Q	38/33/29/21	40/34/29/21	40/35/30/21	43/36/30/21
	Heating		41/35/31/22	42/36/31/22	42/38/33/22	44/39/33/24
Sound Power Level	Cooling	H	54	55	56	57
	Heating		56	57	58	59
Airflow Rate	Cooling	H/M/L/Q	650/540/430/270	700/560/430/270	700/560/430/270	770/600/450/280
	Heating		720/580/460/330	750/610/470/330	770/640/520/330	800/660/520/340
Net Dimensions	mm		270 × 834 × 215	270 × 834 × 215	270 × 834 × 215	270 × 834 × 215
Weight	kg		10	10	10	10
Connection Pipe Diameter	Liquid/Gas	mm	6.35/9.52	6.35/9.52	6.35/9.52	6.35/9.52

Wall-mounted type

Model name	Indoor unit		ASEH07KETF ASEH07KETF-B ASYG07KETE ASYG07KETE-B	ASEH09KETF ASEH09KETF-B ASYG09KETE ASYG09KETE-B	ASEH12KETF ASEH12KETF-B ASYG12KETE ASYG12KETE-B	ASEH14KETF ASEH14KETF-B ASYG14KETE ASYG14KETE-B
kW Class	kW		2.0	2.5	3.5	4.0
Power Source	Single phase, ~230 V, 50 Hz					
Sound Pressure Level	Cooling	H/M/L/Q	38/33/29/21	40/34/29/21	40/35/30/21	43/36/30/21
	Heating		41/35/31/22	42/36/31/22	42/38/33/22	44/39/33/24
Sound Power Level	Cooling	H	54	55	55	57
	Heating		56	57	58	59
Airflow Rate	Cooling	H/M/L/Q	650/540/430/270	700/560/430/270	700/560/430/270	770/600/450/280
	Heating		720/580/460/330	750/610/470/330	770/640/520/330	800/660/520/340
Net Dimensions	mm		295 × 950 (wall side: 840) × 230	295 × 950 (wall side: 840) × 230	295 × 950 (wall side: 840) × 230	295 × 950 (wall side: 840) × 230
Weight	kg		11	11	11	11.5
Connection Pipe Diameter	Liquid/Gas	mm	6.35/9.52	6.35/9.52	6.35/9.52	6.35/9.52

Wall-mounted type

Model name	Indoor unit		ASEH07KMCG ASEH07KMCG-B ASYG07KMCE	ASEH09KMCG ASEH09KMCG-B ASYG09KMCE	ASEH12KMCG ASEH12KMCG-B ASYG12KMCE	ASEH14KMCG ASEH14KMCG-B ASYG14KMCE
kW Class	kW		2.0	2.5	3.5	4.0
Power Source	Single phase, ~230 V, 50 Hz					
Sound Pressure Level	Cooling	H/M/L/Q	38/33/29/21	40/34/29/21	40/35/30/21	43/36/30/21
	Heating		41/35/31/22	42/36/31/22	42/38/33/22	44/39/33/24
Sound Power Level	Cooling	H	54	55	55	57
	Heating		56	57	58	59
Airflow Rate	Cooling	H/M/L/Q	650/540/430/320	700/560/430/320	700/560/430/320	770/600/450/310
	Heating		720/580/460/330	750/610/470/330	780/640/520/330	820/660/520/340
Net Dimensions	mm		270 × 834 × 222	270 × 834 × 222	270 × 834 × 222	270 × 834 × 222
Weight	kg		10	10	10	10
Connection Pipe Diameter	Liquid/Gas	mm	6.35/9.52	6.35/9.52	6.35/9.52	6.35/9.52

Wall-mounted type

Model name	Indoor unit		ASEH05KNCA	ASEH07KNCA	ASEH09KNCA	ASEH12KNCA
kW Class	kW		1.5	2.0	2.5	3.5
Power Source	Single phase, ~230 V, 50 Hz					
Sound Pressure Level	Cooling	H/M/L/Q	34 / 33 / 29 / 21	36 / 33 / 29 / 21	41 / 35 / 29 / 21	42 / 36 / 32 / 21
	Heating		34 / 32 / 30 / 22	36 / 33 / 30 / 22	41 / 34 / 30 / 22	42 / 35 / 31 / 22
Sound Power Level	Cooling	H	50	51	56	57
	Heating		50	51	56	57
Airflow Rate	Cooling	H/M/L/Q	500 / 450 / 390 / 250	530 / 460 / 390 / 250	640 / 500 / 390 / 250	660 / 520 / 440 / 250
	Heating		500 / 450 / 420 / 280	530 / 460 / 420 / 280	640 / 500 / 420 / 280	660 / 520 / 440 / 280
Net Dimensions	mm		270 × 784 × 222	270 × 784 × 222	270 × 784 × 222	270 × 784 × 222
Weight	kg		9	9	9	9
Connection Pipe Diameter	Liquid/Gas	mm	6.35 / 9.52	6.35 / 9.52	6.35 / 9.52	6.35 / 9.52

Wall-mounted type

Model name	Indoor unit		ASEG18KMTE	ASEG22KMTE	ASEG24KMTE
kW Class	kW		5.0	6.0	7.0
Power Source	Single phase, ~230 V, 50 Hz				
Sound Pressure Level	Cooling	H/M/L/Q	45/40/35/29	48/40/35/29	49/40/35/29
	Heating		46/40/35/29	48/40/35/29	49/40/35/29
Sound Power Level	Cooling	H	60	62	65
	Heating		61	62	65
Airflow Rate	Cooling	H/M/L/Q	980/810/640/510	1,060/810/640/510	1,170/850/640/510
	Heating		1,020/850/640/510	1,060/850/640/510	1,170/850/640/510
Net Dimensions	mm		280 × 980 × 240	280 × 980 × 240	280 × 980 × 240
Weight	kg		12.5	12.5	12.5
Connection Pipe Diameter	Liquid/Gas	mm	6.35/12.70	6.35/12.70	6.35/12.70

Floor

Model name	Indoor unit		AGEG09KVCA	AGEG12KVCA	AGEG14KVCA
kW Class	kW		2.5	3.5	4.0
Power Source	Single phase, ~230 V, 50 Hz				
Sound Pressure Level	Cooling	H/M/L/Q	39/34/28/22	42/36/30/22	44/38/31/22
	Heating		39/35/30/22	42/38/32/22	44/39/33/22
Sound Power Level	Cooling	H	52	55	56
	Heating		52	55	56
Airflow Rate	Cooling	H/M/L/Q	530/440/360/270	600/490/380/270	650/520/400/270
	Heating		530/460/380/270	600/510/410/270	650/540/430/270
Net Dimensions	mm		600 × 740 × 200	600 × 740 × 200	600 × 740 × 200
Weight	kg		14	14	14
Connection Pipe Diameter	Liquid/Gas	mm	6.35/9.52	6.35/9.52	6.35/9.52

2-unit to 5-unit Multi-split Indoor Units Specifications

Ceiling



Model name	Indoor unit		ABEG18KRTA		ABEG22KRTA		
kW Class	kW		5.0		6.0		
Power Source	Single phase, ~230 V, 50 Hz						
Sound Pressure Level	Cooling	H/M/L/Q	dB(A)	38/36/33/31		42/37/34/31	
	Heating			38/36/33/31		42/37/34/31	
Sound Power Level	Cooling	H	dB(A)	53		57	
	Heating			53		57	
Airflow Rate	Cooling	H/M/L/Q	m³/h	840/790/710/650		900/790/710/650	
	Heating			840/790/710/650		900/790/710/650	
Net Dimensions	mm		235 × 1,080 × 705		235 × 1,080 × 705		
Weight	kg		24		24		
Connection Pipe Diameter	Liquid/Gas	mm		6.35/12.70		6.35/12.70	

Compact Cassette Grid Type



Model name	Indoor unit		AUXG07KVLA	AUXG09KVLA	AUXG12KVLA	AUXG14KVLA	AUXG18KVLA	AUXG22KVLA	
kW Class	kW		2.0	2.5	3.5	4.0	5.0	6.0	
Power Source	Single phase, ~230 V, 50 Hz								
Sound Pressure Level	Cooling	H/M/L/Q	dB(A)	33/31/29/27		37/34/31/28		38/35/32/29	
	Heating			34/32/29/27		43/38/34/30		45/43/40/33	
Sound Power Level	Cooling	H	dB(A)	46		49		50	
	Heating			47		55		57	
Airflow Rate	Cooling	H/M/L/Q	m³/h	540/490/440/390		610/530/470/410		680/580/490/410	
	Heating			540/490/440/390		790/680/580/450		860/760/700/530	
Net Dimensions	mm		245 × 570 × 570		245 × 570 × 570		245 × 570 × 570		
Weight	kg		15		15		16		
Panel			UTG-UFYF-W		UTG-UFYF-W		UTG-UFYF-W		
Connection Pipe Diameter	Liquid/Gas	mm		6.35/9.52		6.35/9.52		6.35/12.70	

Mini duct



Model name	Indoor unit		ARXG07KSLAP	ARXG09KSLAP	ARXG12KSLAP	ARXG14KSLAP	ARXG18KSLAP		
kW Class	kW		2.0	2.5	3.5	4.0	5.0		
Power Source	Single phase, ~230 V, 50 Hz								
Sound Pressure Level	Cooling	H/M/L/Q	dB(A)	29/26/24/23		31/27/25/23		35/30/27/23	
	Heating			29/26/24/23		31/27/25/23		33/29/26/23	
Sound Power Level	Cooling	H	dB(A)	52		55		60	
	Heating			53		62		59	
Airflow Rate	Cooling	H/M/L/Q	m³/h	550/440/390/360		650/490/430/360		800/640/530/360	
	Heating			550/440/390/360		650/490/430/360		940/750/540/480	
Net Dimensions	mm		198 × 700 × 450		198 × 700 × 450		198 × 700 × 450		
Weight	kg		15.5		15.5		18.5		
Connection Pipe Diameter	Liquid/Gas	mm		6.35/9.52		6.35/9.52		6.35/12.70	
External static pressure	Pa		0 to 30		0 to 30		0 to 50		
Drain pump			Standard		Standard		Standard		

Slim duct



Model name	Indoor unit		ARXG07KLLAP	ARXG09KLLAP	ARXG12KLLAP	ARXG14KLLAP	ARXG18KLLAP		
kW Class	kW		2.0	2.5	3.5	4.0	5.0		
Power Source	Single phase, ~230 V, 50 Hz								
Sound Pressure Level	Cooling	H/M/L/Q	dB(A)	28/27/26/25		29/28/27/26		32/30/28/26	
	Heating			28/26/25/24		29/28/27/24		32/30/28/25	
Sound Power Level	Cooling	H	dB(A)	57		58		60	
	Heating			57		58		58	
Airflow Rate	Cooling	H/M/L/Q	m³/h	550/490/470/440		650/600/550/480		800/700/600/480	
	Heating			550/490/470/440		650/600/550/480		940/880/820/750	
Net Dimensions	mm		198 × 700 × 620		198 × 700 × 620		198 × 700 × 620		
Weight	kg		16		17		20		
Connection Pipe Diameter	Liquid/Gas	mm		6.35/9.52		6.35/9.52		6.35/12.70	
External static pressure	Pa		0 to 90		0 to 90		0 to 90		
Drain pump			Standard		Standard		Standard		

Medium Static Pressure Duct

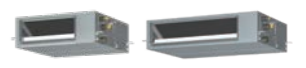

Model name	Indoor unit		ARXH12KMTAP	ARXH14KMTAP	ARXH18KMTAP	ARXH22KMTAP	
kW Class	kW		3.5	4.0	5.0	6.0	
Power Source	Single-phase, ~230V, 50Hz						
Sound Pressure Level	Cooling	H/M/L/Q	dB(A)	29 / 27 / 25 / 23		32 / 29 / 27 / 25	
	Heating			29 / 27 / 25 / 23		33 / 30 / 28 / 26	
Sound Power Level	Cooling	H	dB(A)	58		59	
	Heating			58		60	
Airflow Rate	Cooling	H/M/L/Q	m³/h	650 / 520 / 460 / 390		800 / 640 / 560 / 480	
	Heating			650 / 520 / 460 / 390		840 / 720 / 630 / 540	
Net Dimensions	mm		240 × 700 × 700		240 × 700 × 700		
Weight	kg		24		24		
Connection Pipe Diameter	Liquid/Gas	mm		6.35 / 9.52		6.35 / 12.7	
External static pressure	Pa		30 to 150		30 to 150		
Drain pump			Standard		Standard		

Medium Static Pressure Duct



Model name	Indoor unit		ARXG22KMLB
kW Class	kW		6.0
Power Source	Single phase, ~230 V, 50 Hz		
Sound Pressure Level	Cooling	H/M/L/Q	dB(A)
	Heating		
Sound Power Level	Cooling	H	dB(A)
	Heating		
Airflow Rate	Cooling	H/M/L/Q	m³/h
	Heating		
Net Dimensions	mm		270 × 1,135 × 700
Weight	kg		35
Connection Pipe Diameter	Liquid/Gas	mm	
External static pressure	Pa		30 to 150
Drain pump			Option

2-unit Multi-split Combination Table-Cooling/Heating

2-unit Multi-split cooling

AOEG14KBCA2	Combination of Indoor Units		Cooling Operation				Seasonal Data			
			Cooling Capacity			Input Power (Min. - Max.) kW	EER	Pdesign kW	SEER	Energy efficiency class
			Unit 1 kW	Unit 2 kW	Total Capacity (Min. - Max.) kW					
2-unit connection	7	7	2.00	2.00	4.00 (1.4-4.6)	0.97 (0.25-1.20)	4.12	4.0	8.7	A+++
	7	9	1.75	2.25	4.00 (1.4-4.6)	0.97 (0.25-1.20)	4.12	4.0	8.7	A+++
	7	12	1.47	2.53	4.00 (1.4-4.6)	0.97 (0.25-1.20)	4.12	4.0	8.7	A+++
	9	9	2.00	2.00	4.00 (1.4-4.6)	0.97 (0.25-1.20)	4.12	4.0	8.7	A+++
	9	12	1.71	2.29	4.00 (1.4-4.6)	0.97 (0.25-1.20)	4.12	4.0	8.7	A+++

Notes: •7: 7000 Btu/h/9: 9000 Btu/h/12: 12000 Btu/h models
 •The above specifications apply when connected with a wall-mounted [KG/KM] unit.
 •2 or more indoor units should be connected.
 •Cooling capacity is determined based on 27°CDB/19°CWB (indoor temperature) and 35°CDB (outdoor temperature).
 •Pipe Length: 5 m, Height difference: 0 m (Outdoor unit to Indoor unit)
 •Total capacity of indoor units connected must be between 4.0 kW and 6.0 kW.
 •Please refer to the Design & Technical manual for the combination tables with 5kW model.

AOEG18KBCA2	Combination of Indoor Units		Cooling Operation				Seasonal Data			
			Cooling Capacity			Input Power (Min. - Max.) kW	EER	Pdesign kW	SEER	Energy efficiency class
			Unit 1 kW	Unit 2 kW	Total Capacity (Min. - Max.) kW					
2-unit connection	7	7	2.00	2.00	4.00 (1.7-5.0)	0.92 (0.25-1.23)	4.35	4.0	8.8	A+++
	7	9	2.00	2.50	4.50 (1.7-5.7)	1.07 (0.25-1.45)	4.22	4.5	8.7	A+++
	7	12	1.84	3.16	5.00 (1.7-5.8)	1.24 (0.25-1.55)	4.03	5.0	8.6	A+++
	7	14	1.67	3.33	5.00 (1.7-5.8)	1.24 (0.25-1.55)	4.03	5.0	8.6	A+++
	9	9	2.50	2.50	5.00 (1.7-5.8)	1.24 (0.25-1.55)	4.03	5.0	8.6	A+++
	9	12	2.14	2.86	5.00 (1.7-5.8)	1.24 (0.25-1.55)	4.03	5.0	8.6	A+++
	9	14	1.96	3.04	5.00 (1.7-5.8)	1.24 (0.25-1.55)	4.03	5.0	8.6	A+++
	12	12	2.50	2.50	5.00 (1.7-5.8)	1.24 (0.25-1.55)	4.03	5.0	8.6	A+++
	12	14	2.31	2.69	5.00 (1.7-5.8)	1.24 (0.25-1.55)	4.03	5.0	8.6	A+++

Notes: •7: 7000 Btu/h/9: 9000 Btu/h/12: 12000 Btu/h/14: 14000 Btu/h models
 •The above specifications apply when connected with a wall-mounted [KG/KM] unit.
 •2 or more indoor units should be connected.
 •Cooling capacity is determined based on 27°CDB/19°CWB (indoor temperature) and 35°CDB (outdoor temperature).
 •Pipe Length: 5 m, Height difference: 0 m (Outdoor unit to Indoor unit)
 •Total capacity of indoor units connected must be between 4.0 kW and 7.5 kW.
 •Please refer to the Design & Technical manual for the combination tables with 5kW model.

2-unit Multi-split heating

AOEG14KBCA2	Combination of Indoor Units		Heating Operation				Seasonal Data			
			Heating Capacity			Input Power (Min. - Max.) kW	COP	Pdesign kW	SCOP	Energy efficiency class
			Unit 1 kW	Unit 2 kW	Total Capacity (Min. - Max.) kW					
2-unit connection	7	7	2.20	2.20	4.40 (1.1-5.5)	0.95 (0.25-1.65)	4.63	3.5	4.7	A++
	7	9	1.92	2.48	4.40 (1.1-5.5)	0.95 (0.25-1.65)	4.63	3.5	4.7	A++
	7	12	1.62	2.78	4.40 (1.1-5.5)	0.95 (0.25-1.65)	4.63	3.5	4.7	A++
	9	9	2.20	2.20	4.40 (1.1-5.5)	0.95 (0.25-1.65)	4.63	3.5	4.7	A++
	9	12	1.89	2.51	4.40 (1.1-5.5)	0.95 (0.25-1.65)	4.63	3.5	4.7	A++

Notes: •7: 7000 Btu/h/9: 9000 Btu/h/12: 12000 Btu/h models
 •The above specifications apply when connected with a wall-mounted [KG/KM] unit.
 •2 or more indoor units should be connected.
 •Heating capacity is determined based on 20°CDB (indoor temperature) and 7°CDB/6°CWB (outdoor temperature).
 •Pipe Length: 5 m, Height difference: 0 m (Outdoor unit to Indoor unit)
 •Total capacity of indoor units connected must be between 4.0 kW and 6.0 kW.
 •Please refer to the Design & Technical manual for the combination tables with 5kW model.

AOEG18KBCA2	Combination of Indoor Units		Heating Operation				Seasonal Data			
			Heating Capacity			Input Power (Min. - Max.) kW	COP	Pdesign kW	SCOP	Energy efficiency class
			Unit 1 kW	Unit 2 kW	Total Capacity (Min. - Max.) kW					
2-unit connection	7	7	2.40	2.40	4.80 (1.7-5.6)	0.99 (0.25-1.35)	4.85	3.8	4.7	A++
	7	9	2.40	3.00	5.40 (1.7-6.4)	1.15 (0.25-1.60)	4.70	4.0	4.7	A++
	7	12	2.06	3.54	5.60 (1.7-7.0)	1.22 (0.25-1.80)	4.59	4.2	4.7	A++
	7	14	1.87	3.73	5.60 (1.7-7.0)	1.22 (0.25-1.80)	4.59	4.2	4.7	A++
	9	9	2.80	2.80	5.60 (1.7-7.0)	1.22 (0.25-1.80)	4.59	4.2	4.7	A++
	9	12	2.40	3.20	5.60 (1.7-7.0)	1.22 (0.25-1.80)	4.59	4.2	4.7	A++
	9	14	2.19	3.41	5.60 (1.7-7.0)	1.22 (0.25-1.80)	4.59	4.2	4.7	A++
	12	12	2.80	2.80	5.60 (1.7-7.0)	1.22 (0.25-1.80)	4.59	4.2	4.7	A++
	12	14	2.58	3.02	5.60 (1.7-7.0)	1.22 (0.25-1.80)	4.59	4.2	4.7	A++

Notes: •7: 7000 Btu/h/9: 9000 Btu/h/12: 12000 Btu/h/14: 14000 Btu/h models
 •The above specifications apply when connected with a wall-mounted [KG/KM] unit.
 •2 or more indoor units should be connected.
 •Heating capacity is determined based on 20°CDB (indoor temperature) and 7°CDB/6°CWB (outdoor temperature).
 •Pipe Length: 5 m, Height difference: 0 m (Outdoor unit to Indoor unit)
 •Total capacity of indoor units connected must be between 4.0 kW and 7.5 kW.
 •Please refer to the Design & Technical manual for the combination tables with 5kW model.

5-unit Multi-split Cooling Combination Table-Cooling

5-unit Multi-split cooling

A0EG36K8TA5	Combination of Indoor Units					Cooling Operation							Seasonal Data				
						Cooling Capacity					Input Power (Min. - Max.)	EER	Pdesign kW	SEER	Energy efficiency		
						Unit 1	Unit 2	Unit 3	Unit 4	Unit 5						Total Capacity (Min. - Max.)	
						kW	kW	kW	kW	kW	kW	kW					
2-unit connection	7	24	-	-	-	2.00	7.00	-	-	-	9.00 (3.0-11.0)	2.91 (0.30-3.45)	3.09	9.0	7.9	A++	













































5-unit Multi-split cooling

A0EG36K8TA5	Combination of Indoor Units					Cooling Operation							Seasonal Data				
						Cooling Capacity					Input Power (Min. - Max.)	EER	Pdesign kW	SEER	Energy efficiency		
						Unit 1	Unit 2	Unit 3	Unit 4	Unit 5						Total Capacity (Min. - Max.)	
						kW	kW	kW	kW	kW	kW	kW					
4-unit connection	7	14	14	18	-	1.25	2.51	2.51	3.23	-	9.50 (3.0-11.0)	2.69 (0.30-3.45)	3.53	9.5	8.3	A++	

Notes: *7: 7000 Btu/h/9: 9000 Btu/h/12: 12000 Btu/h/14: 14000 Btu/h/18: 18000 Btu/h/22: 22000 Btu/h/24: 24000 Btu/h models
 *The above specifications apply when connected with a wall-mounted [KG/KM] unit.
 *2 or more indoor units should be connected.
 *Cooling capacity is determined based on 27°CDB/19°CWB (indoor temperature) and 35°CDB (outdoor temperature).
 *Pipe Length: 5 m. Height difference: 0 m (Outdoor unit to Indoor unit)
 *Total capacity of indoor units connected must be between 7.5 kW and 15.5 kW.
 *Please refer to the Design & Technical manual for the combination tables with 5kW model.
 *1: For Model 22, only wall-mounted indoor units are connectable.

MULTI-SPLIT

Feature Summary

Type	Wall-mounted type				Wall-mounted type			
Series	Designer Series		Standard Series		Standard Series		Designer Series	Standard Series
Model name	 ASEH07/09/12/14KGTG ASYG07/09/12/14KGTE	 ASEG07/09/12/14KETF, ASEG07/09/12/14KETF-B, ASYG07/09/12/14KETE, ASYG07/09/12/14KETE-B	 ASEH07/09/12/14KMCG ASEH07/09/12/14KMCG-B ASYG07/09/12/14KMCE	 ASEH05/07/09/12KNCA	 ASEG18/22/24KMTE	 ASYG07/09/12/14LUCA	 ASYG07/09/12/14LMCE	 ASYG18LFCA, ASYG24LFCC
Refrigerant								
Energy-saving Features	 Save Occupancy sensor	●						
	 Economy operation	●	●	●	●	●	●	●
	 Setting temperature range limitation	○	○	○		○	○	○
	 Set temperature auto return	○	○	○		○	○	○
Features for Comfort	 Power diffuser						●	●
	 Powerful operation	●	●	●	●	●		
	 10°C Heat	●	●	●	●	●	●	●
	 Outdoor unit low noise operation	●	●	●	●	●		
	 Auto changeover	●	●	●	●	●	●	●
	 UP/DOWN swing louver	●	●	●	●	●	●	●
	 Double swing automatic				●	●		●
	 Automatic fan speed	●	●	●	●	●	●	●
	 Auto restart	●	●	●	●	●	●	●
	 Connectable fresh air duct							
	 Fresh air intake							
	 Connectable distributing duct							
	Convenience Features	 Auto-off timer	○	○	○	●	○	○
 Sleep timer		●	●	●	●	●	●	●
 Program timer		●	●	●	●	●	●	●
 Weekly timer		●	●	○	○	●	●	
 Weekly & Temperature setback timer		○	○	○		○	○	○
 Filter sign		●	●	●	●	●	●	●
 External error output		○	○	○		○	○	○
 External ON/OFF input		○	○	○		○	○	○
 Wireless LAN control		● (KGTG), ○ (KGTE)	● (KETF, KETF-B), ○ (KETE, KETE-B)	● (KMCG, KMCG-B), ○ (KMCE)	●	○	○	○
 Ion deodorization filter		●	●	●		●	●	●
Clean Features	 Apple-catechin filter	●	●	●		●	●	●
	 Long-life filter							
	 Washable panel	●	●	●	●	●	●	●
	 Silver Ion Filter	○	○	○	○	○	○	○
	Installation / Support	 Automatic airflow adjustment						
 Drain pump as standard								
 Blue fin					●			●
 Refrigerant cycle monitor								● (30)

○ : Optional function

Feature Summary

Type	Cassette			Duct			Duct			Floor	Floor/Ceiling	Ceiling			
	Compact 4-way Flow Grid type Series	Compact 4-way Flow Series	4-way Flow Series	Mini (With drain pump)	Slim (With drain pump)	Slim (With drain pump)	Medium Static Pressure								
Series															
Model name	AUXG 07/09/12/14/18/22/24 KVLA	AUYG07/09/LVLA, AUYG12/14/18/LVLB, AUYG22/24/LVLA	AUYG30/36/LRLE, AUYG36/45/LRLA	ARXG 07/09/12/14/18 KSLAP	ARYG 07/09/12/14/18 LSLAP	ARXG 07/09/12/14/18 KLLAP	ARYG07/09/LLTA, ARYG12/14/18/LLTB	ARXH 12/14/18/22 KMTAP	ARXG22/KMLB, ARXG24/KMLA	ARYG 22/24/36/45 LMLA, ARYG 30/36/LMLE	AGEG09/12/14/KVCA	AGYG09/12/14/LVCA	ABYG14/22/24/LVTA, ABYG18/LVTB	ABEG18/22/KRTA	ABYG30/36/LRTE, ABYG36/45/LRTA
Refrigerant	R32	R410A	R410A	R32	R410A	R32	R410A	R32	R410A	R32	R410A	R410A	R32	R410A	
Energy-saving Features	Save Occupancy sensor														
	Economy operation	●	●	●	●	●	●	○	●	●	●	●	●	●	●
	Setting temperature range limitation	○	○	○	●	●	○	○	○	○	○	○	○	●	○
	Set temperature auto return	●	○	○	●	●	●	○	○	●	○	○	○	●	○
Features for Comfort	Power diffuser														
	Powerful operation										●				
	10°C Heat	●	●	○	○	○	○	○	○	○	●	●	●	○	●
	Outdoor unit low noise operation										●		○	○	○
	Auto changeover	●	●	●	●	●	●	●	●	●	●	●	●	●	●
	UP/DOWN swing louver	●	●	●	○	○	○	○			●	●		●	
	Double swing automatic												●		●
	Automatic fan speed	●	●	●	●	●	●	●	●	●	●	●	●	●	●
	Auto restart	●	●	●	●	●	●	●	●	●	●	●	●	●	●
	Connectable fresh air duct		○	●					●	●	●	●		●	●
	Fresh air intake	○	○	○			○	○	○	○				○	○
	Connectable distributing duct								●	●					
	Convenience Features	Auto-off timer	●	○	○	●	●	●	○	●	●	○	○	○	●
Sleep timer		●	●	○	○	○	○	○	○	○	○	○	○	○	○
Program timer		●	●	○	○	○	○	○	○	○	○	○	○	○	○
Weekly timer		●			●	●	●		●	●	●		●		
Weekly & Temperature setback timer		○	○	●			●	●	●	●		○	○		○
Filter sign		●	●	●	●	●	●	●	●	●	●	●	●	●	●
External error output					○	○					○		○		
External ON/OFF input		●	○	○	●	●	●	○	●	●	○	○	○	●	○
Wireless LAN control		○	○	○	○	○	○	○	○	○	○	○	○	○	○
Clean Features	Ion deodorization filter										●	●			
	Apple-catechin filter										●	●			
	Long-life filter									○	○	○	●	●	
	Washable panel														
	Silver Ion Filter	○	○	○	○	○	○	○	○	○	○	○			
Installation / Support	Automatic airflow adjustment								●						
	Drain pump as standard	●	●	●	●	●	●	●	○	○			○	○	
	Blue fin			(45/54)									(30/36/45/54)	(45)	
	Refrigerant cycle monitor								○						

○ : Optional function