

## Light Commercial & Commercial, Residential CONTROL SYSTEM & OPTIONAL PARTS

- C-002 Control System Overview
- C-006 Best control solution for each building structure
- C-008 Comparison table of controllers
- C-050 Controller System List
- C-058 Optional Parts Overview
- C-066 Optional parts list
- C-070 Function list

A wide product lineup to meet a variety of needs

We can flexibly meet customer needs through a variety of offerings including wired and wireless individual remote controllers, central remote controllers that simultaneously control multiple indoor units, and a variety of converters that link with other systems.

### CONTROL SYSTEM

#### INDIVIDUAL CONTROL

- C-010 Wired remote controller (Design type)
- C-012 Wired remote controller (with touch panel)
- C-014 Wired remote controller / Compact wired remote controller
- C-015 Wired remote controller
- C-016 Simple remote controller
- C-017 Wireless remote controller
- C-018 IR receiver unit

#### CONVERTERS/ADAPTERS

- C-020 WLAN adapter
- C-024 Multiple protocol WLAN adapter

#### CENTRALIZED CONTROL





- C-025 Home central remote controller
- C-026 Central remote controller
- C-028 Touch panel controller
- C-032 System controller Software / System controller lite Software

#### CONVERTERS/ADAPTERS

- C-036 MODBUS® converter for indoor unit
- C-037 MODBUS® interface
- C-038 MODBUS® converter for VRF
- C-039 BACnet® interface
- C-040 BACnet® gateway Software
- C-041 BACnet® gateway Hardware
- C-042 BACnet®/MODBUS® router
- C-043 BACnet®/MODBUS® cloud device
- C-044 KNX® converter for indoor unit / KNX® converter for VRF
- C-045 KNX® interface
- C-046 Network converter for single-split type
- C-047 Network converter for LONWORKS™
- C-048 External switch controller / Signal amplifier

### Optional parts

- C-060 Silver ion filter
- C-061 Auto louver grille kit
- C-062 Pressure sensor kit
- C-063 External power supply unit  
AIR BEAM radiation air outlet unit
- C-064 Gas sensor kit
- C-074 Separation tube and other piping products

-  SPLIT
-  MULTI-SPLIT
-  VRF J Series
-  VRF V Series

# Control System Overview

## for Split & Multi-split

All indoor units\* are equipped with a wireless or wired remote controller as standard. Additional options are available, such as individual remote controllers and central remote controllers. The easy-to-operate central remote controller makes it simple to control the operation mode, temperature, airflow volume, timer, and other functions of each indoor unit from a single location.

\* Except for some products



### Air Conditioning Individual control

**NEW**

**Wired remote controller**  
A built-in thermo sensor monitors and controls room temperature accurately.

**Wireless remote controller**  
Simple and versatile operations with a choice of 4 different types of timers

**Simple remote controller**  
Compact remote controller with basic functionality

**For Ceiling type**

**IR receiver unit**

**For Duct type**

**IR receiver unit**

**For Cassette type**

**IR receiver unit**

This IR receiver unit enables a wireless remote controller to control a duct-type indoor unit.



### Converters/Adapters

For external control via BMS/Home Automation Systems

- MODBUS® converter for indoor units**  
UTY-VMSX
- MODBUS® interface for indoor units**  
Intesis
- KNX® converter for indoor units**  
UTY-VK SX
- KNX® interface for indoor units**  
Intesis
- WLAN adapter**  
Intesis
- Network converter**  
DC power supply type UTY-VTGX      AC power supply type UTY-VTGXV

### Air Conditioning Centralized control

**Home central remote controller for 5 & 6-unit Multi-split type**  
Enables individual and central control.

### Online Control (Wireless Control via Smartphone/Tablet)

With the WLAN adapter and the AIRSTAGE Mobile app, you can control the heating and cooling of your home anytime, anywhere.

**WLAN adapter**  
The dedicated WLAN adapter enables the air conditioner to be operated by smartphone or tablet computer.

**AIRSTAGE Mobile**      **Download Free**  
Available on the App Store and Google Play.

### Simple, user-friendly interface design

The designed screen display makes it easier than ever to operate.

On/Off  
Temperature setting  
Operation mode  
Fan speed  
Timer  
Operation setting  
Economy setting  
Maintenance setting  
Setting

# Control System Overview

## for VRF

To meet the diverse needs of customers, we offer a variety of control options for our VRF systems, such as individual control, centralized control, and building management system (BMS) options.

### Air Conditioning Individual control

- NEW** **Wired remote controller (Design type)**  
UTY-RVRY
- Wired remote controller (with touch panel)**  
UTY-RNRYZ5
- Wired remote controller**  
UTY-RLRY
- Compact wired remote controller**  
UTY-RCRYZ1
- Simple remote controller**  
UTY-RSRY  
UTY-RHRY  
Without operation mode
- NEW** **Wireless Remote Controller**  
UTY-LNVY  
UTY-LNHY
- IR receiver unit**  
UTB-YWC for duct type  
UTY-TRHX for One-way flow cassette Series/3D-flow cassette Series/duct type  
UTY-LBHDX for Circular flow cassette Series

### Air Conditioning Centralized control

**System controller (Software)**  
UTY-APGXZ1/UTY-ALGXZ1 (Lite version)

Up to **1600**<sup>\*2</sup> Indoor units

\*1: Echelon® U10 USB Network Interface  
\*2: The Lite version controls up to 400 indoor units.

**Touch panel controller**  
UTY-DTGYZ1

Up to **400** Indoor units

**NEW** **Central remote controller**  
UTY-DCGYZ3

Up to **100** Indoor units



### Converters/Adapters

For external control via BMS/Home Automation Systems

- BACnet® gateway**  
UTY-ABGXZ1 **Software**
- VTY-VBGX** **Hardware**
- BACnet® interface for Indoor units**  
FG-IR-BMG1Z1
- Network converter (For LONWORKS™)**  
UTY-VLGX
- MODBUS® converter for Indoor units**  
UTY-VMSX
- for VRF**  
UTY-VMGX
- KNX® converter for Indoor units**  
UTY-VKSX
- for VRF**  
UTY-VKGX
- WLAN adapter**  
UTY-TFSXJ3 / UTY-TFSXZ1
- External switch controller**  
UTY-TERX

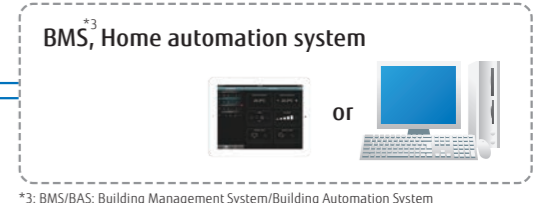

\*3: BMS/BAS: Building Management System/Building Automation System

### Converters/Adapters

for system expansion

- Network converter DC power supply type**  
UTY-VTGX
- Network converter AC power supply type**  
UTY-VTGXV
- Signal amplifier**  
UTY-VSGXZ1



# Best control solution for each building structure

Fujitsu General provides the best control solutions suitable for various building structures.

## SHOP

Type	Individual control			Centralized control			Integrating control (Interface)			
	Wired remote controller	Simple remote controller	Wireless remote controller	Central remote controller	Touch panel controller	System controller	Network converter for LONWORKS™	MODBUS® Converter	KNX® converter	External switch controller
	UTY-RVRY UTY-RNRYZ5 UTY-RLRY UTY-RVNYM UTY-RCRYZ1	UTY-RSRY UTY-RHRY	UTY-LNVY UTY-LNHY UTY-LNTY	UTY-DCGYZ3	UTY-DTGYZ1	UTY-APGXZ1 UTY-ALGXZ1	UTY-VLGX	UTY-VMGX	UTY-VKGX	UTY-TERX
Automatic control of air conditioning (Schedule timer, Weekly timer, etc.)	•	•	•	•	•	•				
Controls limited to staff: Remote controller prohibition, Setting temperature range limitation, etc.		•	•	•	•	•	•	•	•	
Group control		•	•	•	•	•				
Advanced energy saving: Peak cut, Operation of indoor unit rotation, etc.						•				
Remote monitoring management		•	•	•	•	•				
Manage multiple sites		•	•	•	•	•				
Monitor energy consumption						•				
Control third-party products						•				
Integrate Fujitsu General air conditioning into BMS							•	•	•	















## HOTEL

Type	Individual control			Centralized control			Integrating control (Interface)				
	Wired remote controller	Simple remote controller	Wireless remote controller	Central remote controller	Touch panel controller	System controller	BACnet® gateway	Network converter for LONWORKS™	MODBUS® converter	KNX® converter	External switch controller
	UTY-RVRY UTY-RNRYZ5 UTY-RLRY UTY-RCRYZ1	UTY-RSRY UTY-RHRY	UTY-LNVY UTY-LNHY UTY-LNTY	UTY-DCGYZ3	UTY-DTGYZ1	UTY-APGXZ1 UTY-ALGXZ1	UTY-ABGXZ1 UTY-VBGX	UTY-VLGX	UTY-VMGX	UTY-VKGX	UTY-TERX
Local control for hotel guests	•	•	•								
Centralized air conditioning control for common areas				•	•	•	•	•	•	•	
Limited control for hotel guests				•	•	•	•	•	•	•	
Remote monitoring management				•	•	•					
Advanced energy saving: Peak cut, Operation of indoor unit rotation, etc.						•	•				
Monitor energy consumption						•					
Control third-party products						•					
Integrate Fujitsu General air conditioning into BMS							•	•	•	•	
Interlock with window contact											•
Interlock with key card											•

## OFFICE

Type	Individual control			Centralized control			Integrating control (Interface)				
	Wired remote controller	Simple remote controller	Wireless remote controller	Central remote controller	Touch panel controller	System controller	BACnet® gateway	Network converter for LONWORKS™	MODBUS® converter	KNX® converter	External switch controller
	UTY-RVRY UTY-RNRYZ5 UTY-RLRY UTY-RCRYZ1	UTY-RSRY UTY-RHRY	UTY-LNVY UTY-LNHY UTY-LNTY	UTY-DCGYZ3	UTY-DTGYZ1	UTY-APGXZ1 UTY-ALGXZ1	UTY-ABGXZ1 UTY-VBGX	UTY-VLGX	UTY-VMGX	UTY-VKGX	UTY-TERX
Local control for office staff	•	•	•	•							
Automatic control of air conditioning (Schedule timer, Weekly timer, etc.)	•		•	•	•	•	•				
Centralized air conditioning control for management				•	•	•	•	•	•	•	
Controls limited to staff: Remote controller prohibition, Setting temperature range limitation, etc.				•	•	•	•	•	•	•	
Advanced energy saving: Peak cut, Operation of indoor unit rotation, etc.						•	•				
Remote monitoring management				•	•	•					
Electricity charge apportionment					•	•	•				
Monitor energy consumption						•					
Control third-party products						•					
Integrate Fujitsu General air conditioning into BMS							•	•	•	•	
Interlock with door contact											•
Interlock with Human sensor for meeting room				•							•

# Comparison table of controllers

Item																	
Model name	UTY-RVRY	UTY-RNRYZ5	UTY-RLRY	UTY-RVNYM	UTY-RCRYZ1	UTY-RSRY		UTY-RHRY	UTY-LNTY	UTY-LNVY	UTY-LNHY	UTY-DMMYM	UTY-DCGYZ3	UTY-DTGVZ1	UTY-ALGXZ1	UTY-APGXZ1	
Maximum number of controllable remote controller groups	1	1	1	1	1	1		1	1	1	1	1	100	400	400	1600	
Maximum number of controllable indoor units	16	16	16	16	1	16		16	16	16	16	8	100	400	400	1600	
Maximum number of controllable groups	-	-	-	-	-	-		-	-	-	-	-	50	400	400	1600	
Air conditioning control functions	ON/OFF	●	●	●	●	●		●	●	●	●	●	●	●	●	●	
	Operation mode setting	●	●	●	●	●		-	●	●	●	●	●	●	●	●	
	Fan speed control	●	●	●	●	●		●	●	●	●	●	●	●	●	●	
	Room temperature setting	●	●	●	●	●		●	●	●	●	●	●	●	●	●	
	Setting temperature range limitation	●	●	●	●	-		●	-	-	-	-	●	●	●	●	
	Test operation	●	●	●	●	●		●	●	●	●	●	-	●	●	-	
	Vertical louver setting	●	●	●	●	●		●	●	●	●	●	-	●	●	●	
	Horizontal louver setting	●	●	●	●	●		-	-	●	●	●	-	●	●	●	
	Individual louver control	●	●	-	-	●		-	-	-	-	-	-	●*3	-	-	
	Group setting	-	-	-	-	-		-	-	-	-	-	-	●	●	●	
	Remote controller prohibition	-	-	-	-	-		-	-	-	-	-	●	●	●	●	
	Anti-freeze setting	●	●	-	-	●		-	-	-	-	-	●	●	●	●	
	Set temperature auto return	●	●	●	●	-		-	-	-	-	-	-	●	-	-	
	Economy mode setting	●	●	●	●	●		-	●	●	●	●	●	●	●	●	
	Human sensor control	●	●	-	-	-		-	-	-	-	-	●	●	●	●	
	Displayed items	Error	●	●	●	●	●		●	-	-	-	●	●	●	●	●
Defrosting		●	●	●	●	●		●	-	-	-	-	●	●	●	●	
Current time		●	●	●	●	-		-	●	●	●	●	●	●	●	●	
Day of week		●	●	●	●	-		-	-	-	-	-	●	●	●	●	
Remote controller prohibition		●	●	●	●	●		●	-	-	-	-	●	●	●	●	
Address display		●	●	●	●	●		●	-	-	-	-	-	●	●	●	
Room temperature		●	●	-	●	●		●	-	-	-	-	●*4	●*4	●*4	●*4	
Multiple language support		●	●	-	●	-		-	-	-	-	-	●	●	●	●	
Setting for daylight saving time		●	●	-	●	-		-	-	-	-	-	●	●	●	●	
Name registration		●	●	-	-	-		-	-	-	-	-	●	●	●	●	
Backlighting		●	●	-	●	●		●	-	●	-	●	●	●	-	-	
2D floor layout/3D building display		-	-	-	-	-		-	-	-	-	-	-	-	-	●	
Refrigerant leak detector		-	-	-	-	-		-	-	-	-	-	●	●	●	●	
Refrigerant Cycle Monitor		●	●	-	-	-		-	-	-	-	-	-	-	-	-	
Logo Display		●	-	-	-	-		-	-	-	-	-	-	-	-	-	
Limited Visibility of Settings		●	-	-	-	-		-	-	-	-	-	-	-	-	-	
Timer	Schedule timer	Period	Week	Week	Week	Week		-	-	-	-	Week	Year	Year	Year	Year	
		ON/OFF, Temp, Low noise mode*5, Times per day	8	8	4	8	-	-	-	-	-	-	4	20	20	144	144
	ON/OFF timer	-	●	●	●	●(OFF only)		-	●	●	●	-	-	-	-	-	
	Sleep timer	-	-	-	-	-		-	●	●	●	-	-	-	-	-	
	Program timer	-	-	-	-	-		-	●	●	●	-	-	-	-	-	
	Auto-off timer	●	●	●	●	-		-	-	-	-	-	●	●	●	●	
Day off	●	●	●	●	-		-	-	-	-	●	●	●	●	●		
Minimum unit of timer setting (minutes)	1 • 10	10 • 30	30	30	-		-	5	5	5	5	10	10	10	10		
Control	Remote monitoring management system	-	-	-	-	-		-	-	-	-	-	●	●	●	●	
	Electricity charge apportionment	-	-	-	-	-		-	-	-	-	-	-	○	○	●	
	Error history	●	●	●	●	-		-	-	-	-	-	●	●	●	●	
	Emergency stop	-	-	-	-	-		-	-	-	-	-	●*2	●*2	-	-	
	Remote monitoring management	-	-	-	-	-		-	-	-	-	-	●	●	○	●	
	Energy-saving management	-	-	-	-	-		-	-	-	-	-	-	-	○	○	
	E-mail notification in case of failure	-	-	-	-	-		-	-	-	-	-	●	●	●	●	
	Key lock	● Child lock	● Child lock	● Child lock	● Child lock	-		-	-	-	-	-	● Child lock	● Password setting	● Password setting	● Password setting	● Password setting
	Low noise mode	-	-	-	-	-		-	-	-	-	-	●	●	●	●	

\*1 "Operation mode" setting not available.  
 \*2 Available only for external input control.  
 \*3 Monitoring sites can be set up.  
 The main unit side can only be operated to cancel the settings.  
 \*4 Available only when using Wired remote controller.  
 \*5 UTY-DCGYZ3 only  
 ●: Supported ○: Optional function -: Unsupported

# Wired remote controller (Design type)

UTY-RVRY



NEW



Up to 16 indoor units  
Up to 1 group



reddot winner 2024



## Simple and stylish design that harmonizes with the space

- The new stylish design controller, UTY-RVRY, enables intuitive operation with touch screen. It is compatible with many 2-wired indoor units.

## Harmonizes with the Installation Space

When not in use, the controller is a part of the interior décor. This is achieved by using mirrors, glass, and clear panels, and it appears to be one with the wall. The sleek and stylish design won the 2022 Good Design Award and was selected as a finalist for the 2023 IDEA award.



## Intuitive operation

The touch screen is easily operated by swiping vertically and horizontally, and users can operate the controller without using manuals.



## Status LED Colors

When not in use, the operation mode is indicated through LED lamp colors shown under the controller. The LED lamp can be switched ON and OFF to avoid glare at night.



## Features: Wired Remote Controller (Design type)

### Refrigerant cycle monitor

The controller will display specific sensor values of outdoor and indoor units for maintenance and service support.

- \* Display screen example
- \* This function is only supported by split units, using the H-Serial communication protocol! Example: ASYH30KMTB



### Logo Display

The controller can display hotel logos when not in use. Images are sent via Bluetooth® connection where data is saved in the flash memory built into each controller.

\* Color display available

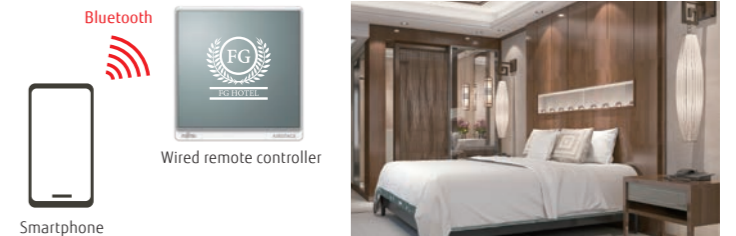

### AIRSTAGE Remo Set application (free download)

Set up your new Wired Remote Controller via Bluetooth from your smartphone (or directly at the controller).

- Features:
- Initial configuration
  - Function setting
  - Custom logo import
  - Copy settings between controllers

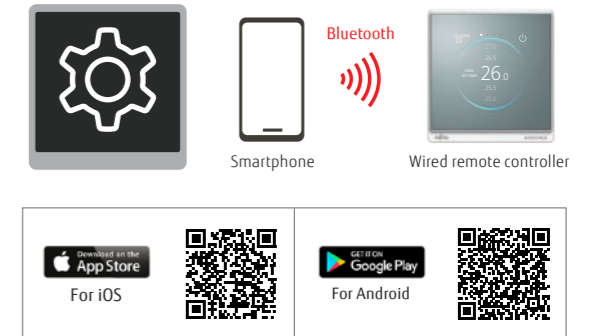

### Initial Settings / Indoor Unit Function

The initial controller settings and indoor unit function settings can be sent from a smartphone by pairing with the controller via Bluetooth. It also can read the setting values of a paired controller, and send a copy of them to one or more additional controllers, significantly reducing installation time.

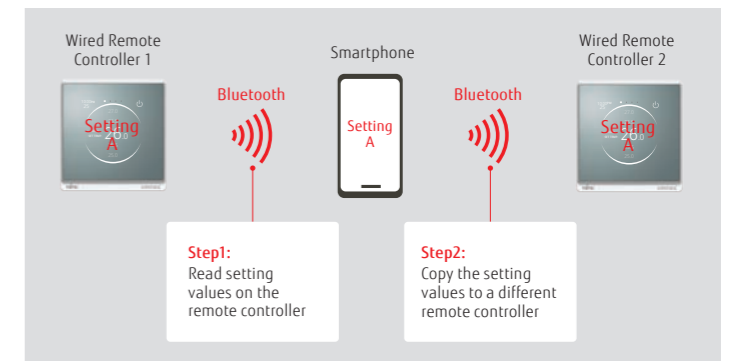

\*Smartphone : Wired Remote Controller = 1 : 1

### Specifications

Model name	UTY-RVRY
Power Source	DC12V
Dimensions (H × W × D) (mm)	121.5 × 116 × 26
Weight (g)	225

# Wired remote controller (with touch panel)

UTY-RNRYZ5



Up to **16** indoor units  
Up to **1** group

## Easy operation due to large high-resolution STN-LCD touch panel screen

- Touch screen LCD
- Built-in daily/weekly timer (ON/OFF, temperature, modes)
- Backlit screen for easy operation in the dark.
- Room temperature display
- Controls up to 16 indoor units
- Supports 12 languages: Chinese, Dutch, English, French, German, Greek, Italian, Polish, Portuguese, Russian, Spanish, and Turkish
- Nonpolar 2-core type

## High performance and compact size

A single remote controller controls each connected indoor unit and provides a weekly timer function and a variety of energy-saving options.



## Accurate control for comfort

A thermo sensor built into the remote controller monitors room temperature accurately.

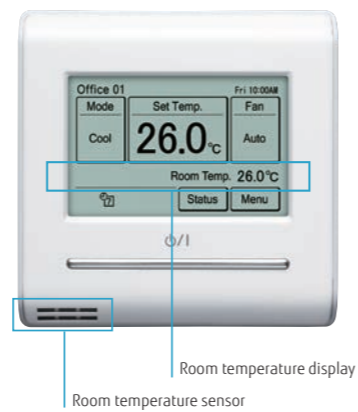

## Energy saving controls

### Custom Auto

- Maintains 2 separate setpoints for heating and cooling operations.
- Automatically switches between heating and cooling modes.

\* Not available for some models

### Auto-off timer

- While the Auto-off timer is activated, if the set off time is specified as, for example, one hour, the power will automatically turn off one hour after the start of operation.
- A desired time frame can be specified for the Auto-off timer.
- The off-time can be set from 30 to 240 minutes.

### 2-setting weekly timer

### Set temperature auto return

### Setting temperature range limitation

Cooling set temp. 27°C, Heating set temp. 26°C

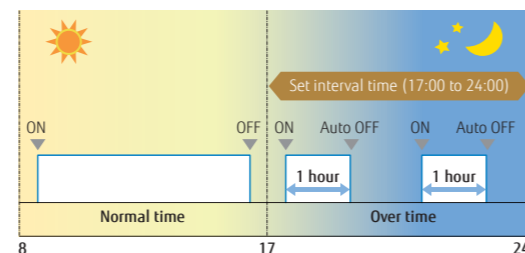
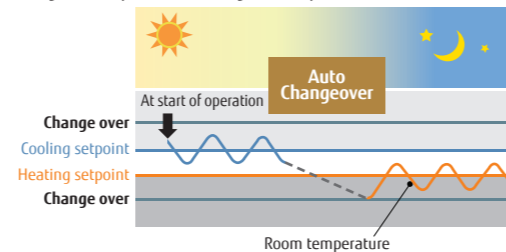

e.g.) Between 17:00 and 24:00 (over time hours), when the 1 hour set off time has elapsed, the system will automatically turn off the indoor unit as it

## Features: Wired Remote Controller (Touch Panel)

### Refrigerant cycle monitor (Option)

Wired Remote Controller (Touch Panel) will support to display some sensor values for maintenance and service support.

\* This function is only supported by split units, using the H-Serial communication protocol! Example: ASYH30KMTB

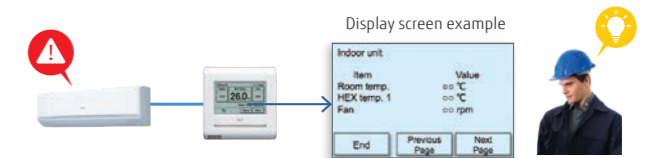

## Multi System Control\*1

### 1) Lead Lag Operation

Standby Indoor Unit can be selected in lead lag operation. By this, the Indoor units will last longer than operating by nonstop.

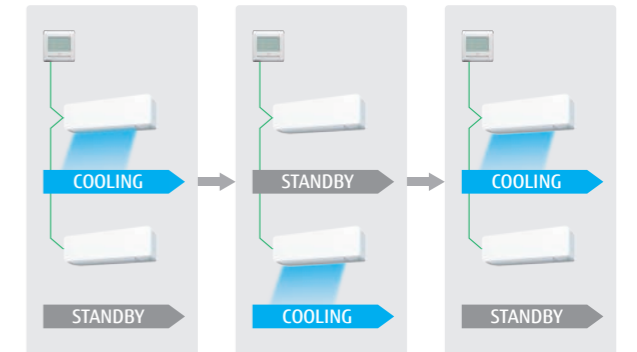

### 2) Back up operation

In case of unexpected Indoor unit error, other Indoor units will start providing back up operation.

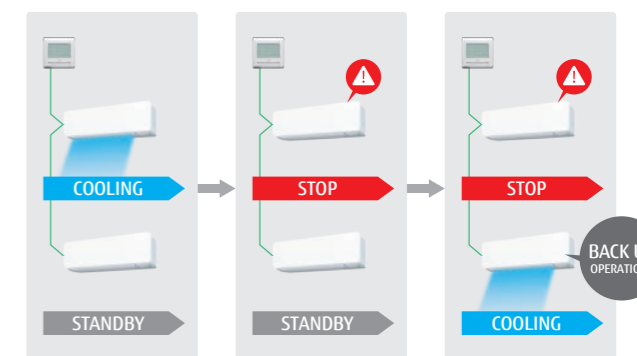

### 3) Lag Operation

In case of unexpected room temperature rise, other Indoor Units will start providing lag operation.

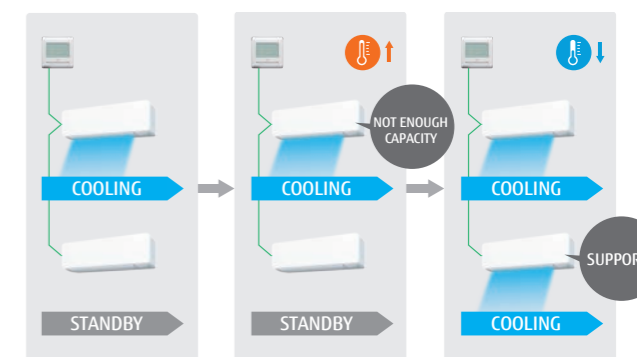

\*1: "Lead Lag Setting" is an easy-to-use function for room temperature control when using multiple indoor units, while reducing the burden placed on each indoor unit.

If you wish to make use of this function, ensure you use indoor units equipped with a "Special Cooling" function.

For Split products with "Special Cooling" function, refer to S-068 to S-071.

If you use indoor units that do not have a "Special Cooling" function, under certain conditions, there is a chance that "Backup operation" may not operate correctly, and the "Lead Lag Setting" function will not give the expected results.

Additionally, for rooms that require strict conditions, such as server rooms, please consider other appropriate measures.

Please note that we will not provide compensation for any damages suffered to your appliances or data as a result of using this function. For more details, please confirm with your nearest retail store.

## Specifications

Model name	UTY-RNRYZ5
Power Source	DC 12 V
Dimensions (H × W × D) (mm)	120 × 120 × 20.4
Weight (g)	220

DC 12 V is supplied by the indoor unit.

## Wired remote controller

UTY-RLRY



- ON/OFF/Weekly timer settings
- A built-in thermo sensor monitors and controls room temperature accurately.
- When something goes wrong, an error code is displayed.
- 16 error codes from the most recent one will be kept in the history. (Last 16 error codes can be accessed)
- Nonpolar 2-core type

Up to  
**16** indoor units  
Up to  
**1** group

### High performance and compact size

A single remote controller controls each connected indoor unit and provides a weekly timer function and a variety of energy-saving options.



### Visually intuitive operation

- The operation mode, set temperature, and fan speed are shown prominently on the top screen.
- Each function to be set is indicated by an icon.
- The control guide makes it simple and straightforward to operate a remote controller.

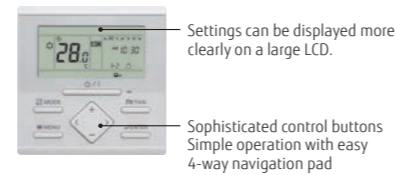

## Compact wired remote controller

UTY-RCRYZ1

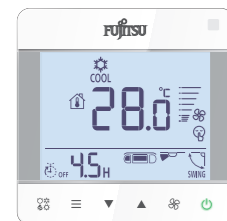

- Simple design that matches stylish interiors
- The body of the controller, which is easy to install, is designed to conform to the European standard junction box.
- Can be operated both by wireless and wired remote controller.
- Nonpolar 2-core type

Up to  
**1** indoor units  
Up to  
**1** group

### Large screen and simple display

- Large screen but compact size
- Large, easy-to-read letters are used.
- The controls are simple and easy to understand.

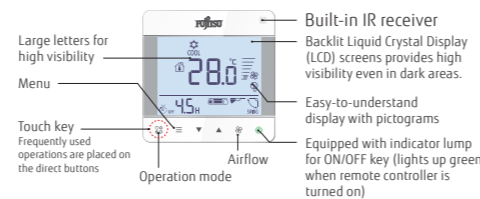

### System overview

#### VRF connection

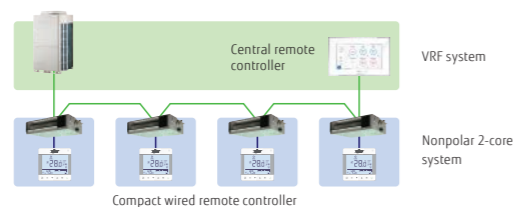

#### RAC connection

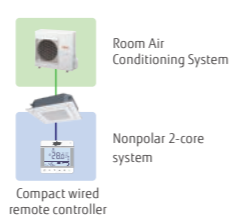

### Specifications

Model name	UTY-RLRY	UTY-RCRYZ1
Power source	12 V DC	12 V DC
Dimensions (H × W × D) (mm)	120 × 120 × 17	86 × 86 × 44
Weight (g)	170	135

12 V DC supplied by an indoor unit

## Wired remote controller

UTY-RVNYM



Up to  
**16** indoor units  
Up to  
**1** group

### Hi-grade individual control with a wide range of functions.

- 3.7-inch backlit LCD screen.
- Supports energy-saving functions with simple operation.
- Supports 9 languages: English, French, German, Greek, Italian, Portuguese, Russian, Spanish, and Turkish

### Visually intuitive operation

- Each function is displayed as an icon.
- Main functions are indicated by large icons: "Mode," "Set Temp," and "Fan"
- Easy operation with control guide display
- Simple operation with easy 4-way navigation pad

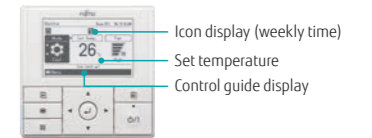

### High performance and compact size

- A single remote controller controls each connected indoor unit and provides a variety of energy-saving options.



## Wired remote controller

UTY-RNNYM



Up to  
**16** indoor units  
Up to  
**1** group

- Simple operation with Built-in Weekly/Daily Timer.
- Control up to 16 indoor units.
- Up to 2 Wired remote controllers can be connected to a single indoor unit.

### Accurate control for comfort

A thermo sensor built into the remote controller monitors room temperature accurately. The wired remote controller and an optional Remote sensor can be installed in any location to meet any requirement.

#### Examples of sensor changes

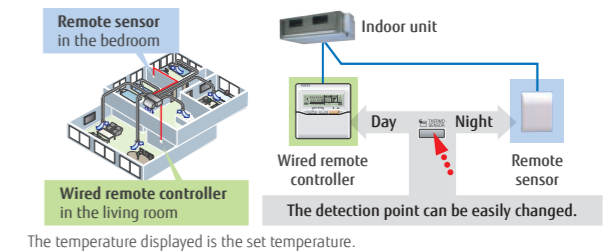

### Built-in timer

**Weekly timer:** ON/OFF time can be set to operate twice for each day of the week.  
**Temperature setback timer:** Sets the time to change the temperature setting and the time to hold the setting for each day of the week.  
 At "Weekly timer" + "Temperature setback timer" setup

### Specifications

Model name	UTY-RVNYM	UTY-RNNYM
Power source	12 V DC	12 V DC
Dimensions (H × W × D) (mm)	120 × 120 × 21.3	120 × 120 × 18
Weight (g)	220	160

12 V DC supplied by an indoor unit



## Simple remote controller

UTY-RSRY / UTY-RHRY (without operation mode)

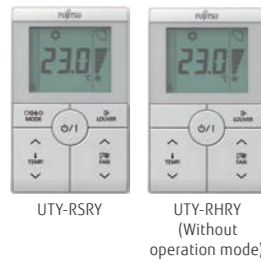

### Compact remote controller with basic functionality

- Up to 16 indoor units can be controlled with one remote controller.
- Suitable for hotels or offices as it is easily operated with no complex functions.
- Simple design that matches stylish interiors
- Large LCD screen and easy-to-use control buttons
- Backlight: White backlight makes it easy to operate in the dark.
- Nonpolar 2-core type

Up to  
**16** indoor units  
Up to  
**1** group

### Supports a variety of applications

- **Vertical louver control:** Adjusts the vertical airflow direction of a duct-type indoor unit with an auto louver or a cassette type installed in a hotel room or a conference room.



- **Setting temperature range limitation:** Enables an indoor unit to operate in an energy-saving manner in a small building not equipped with a central remote controller.

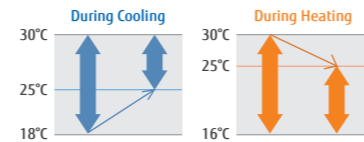

- **Built-in room temperature sensor:** Monitors and controls room temperature accuracy.

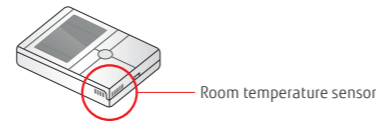

## Wireless remote controller

UTY-LNTY



### Simple and versatile operations with a choice of 4 different types of timers

- Controls up to 16 indoor units.

### Built-in timer

4 timer programs: ON/OFF/Program/Sleep  
Program timer: Sets ON/OFF time once for every 24 hours.  
Sleep timer: Adjusts the set temperature automatically while the sleep timer is on.

### Easy installation and operation

Different codes can be assigned to up to 4 indoor units to prevent a mix-up.  
Wide and precise transmitting range

Up to  
**16** indoor units  
Up to  
**1** group  
Up to  
**4** different daily timers

#### Specifications

Model name	UTY-RSRY	UTY-RHRY	UTY-LNTY
Power source	12 V DC	12 V DC	3.0V (1.5V R03/LR03/AAA x 2)
Dimensions (H × W × D) (mm)	120 × 75 × 19.4	120 × 75 × 19.4	205 × 61 × 17
Weight (g)	120	120	125

12 V DC supplied by an indoor unit

## Wireless remote controller

UTY-LNVY



NEW



Up to  
**16** indoor units  
Up to  
**1** group  
Up to  
**4** different daily timers

### New stylish design with backlight

- It has adopted a new simple and stylish design.
- The built-in backlight allows the screen to be seen even in dark rooms.

### Built-in timer

4 timer programs: ON/OFF/Program/Sleep  
Program timer: Sets ON/OFF time once for every 24 hours.  
Sleep timer: Adjusts the set temperature automatically while the sleep timer is on.

### Error diagnosis

It can detect the reason for system errors easily.  
When an error is detected, the error code number can be checked using the remote controller display.

### Precise control

The setting temperature can be adjusted precisely depending on the environment as the controller can set the temperature via 0.5 °C\*.

\*Depends on the indoor unit

## Wireless remote controller

UTY-LNHY



Up to  
**16** indoor units  
Up to  
**1** group  
Up to  
**4** different daily timers

### Simple and versatile operations with a choice of 4 different types of timers

- Controls up to 16 indoor units.

### Built-in timer

4 timer programs: ON/OFF/Program/Sleep  
Program timer: Sets ON/OFF time once for every 24 hours.  
Sleep timer: Adjusts the set temperature automatically while the sleep timer is on.

### Easy installation and operation

Different codes can be assigned to up to 4 indoor units to prevent a mix-up.  
Wide and precise transmitting range

#### Specifications

Model name	UTY-LNVY	UTY-LNHY
Battery	3.0V (1.5V R03/LR03/AAA x 2)	3.0V (1.5V R03/LR03/AAA x 2)
Dimensions (H × W × D) (mm)	181 × 58 × 17	170 × 56 × 19
Weight (g)	116	85

12 V DC supplied by an indoor unit

## IR receiver unit for duct type UTY-LRHYM / UTY-LBTYM

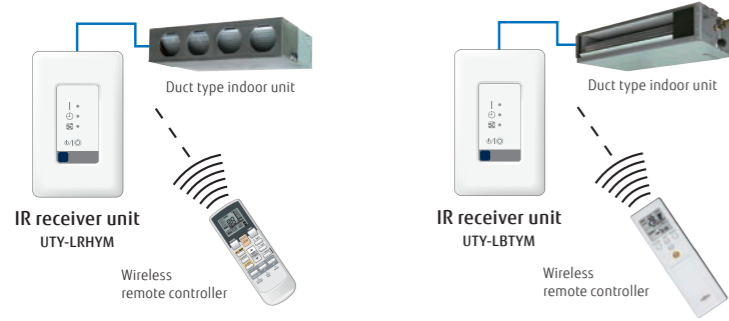

The wireless remote controller controls duct type indoor units.

## IR receiver unit for Cassette UTY-LBTYC



Cassette type indoor unit can be controlled with a Wireless remote controller.

## IR receiver unit for ceiling type UTY-LBTYH



The wireless remote controller controls ceiling type indoor units.

### Specifications

< Wireless Remote Controller >

Model name	UTY-LRHYM	UTY-LBTYM	UTY-LBTYC	UTY-LBTYH
Battery	1.5 V (R03/LR03/AAA)	1.5 V (R03/LR03/AAA)	1.5 V (R03/LR03/AAA)	1.5 V (R03/LR03/AAA)
Dimensions (H × W × D) (mm)	170 × 56 × 19	205 × 61 × 17	205 × 61 × 17	205 × 61 × 17
Weight (g)	85	125	125	125

< IR Receiver Unit >

Battery	DC5V	DC5V	DC5V	DC5V
Dimensions (H × W × D) (mm)	145 × 90 × 30	145 × 90 × 30	-*	-*
Weight (g)	150	150	140	100

DC 5 V is supplied the indoor unit.

\*It will replace the parts of the indoor unit to be connected.

## IR receiver unit for duct type UTB-YWC / UTY-TRHX



The wireless remote controller controls duct type\* indoor units.

\*Large airflow duct types do not work with this IR receiver unit.



\*A separate wireless remote control (model: UTY-LNHY) is required.

## IR receiver unit for Cassette UTY-LBHXD / UTY-TRHX



Cassette type indoor unit can be controlled with a Wireless remote controller.

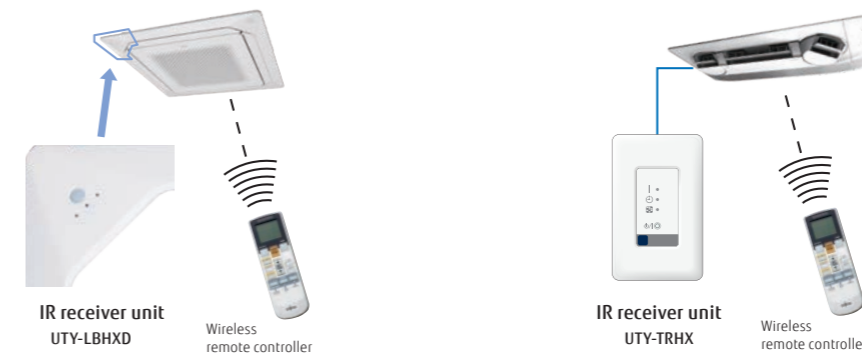

\*A separate wireless remote control (model: UTY-LNVY or UTY-LNHY) is required.

### Specifications

< Wireless Remote Controller >

Model name	UTB-YWC	UTY-LBHXD	UTY-TRHX
Battery	1.5 V (R03/LR03/AAA)	1.5 V (R03/LR03/AAA)	1.5 V (R03/LR03/AAA)
Dimensions (H × W × D) (mm)	170 × 56 × 19	170 × 56 × 19	170 × 56 × 19
Weight (g)	85	85	85

< IR Receiver Unit >

Battery	DC5V	DC5V	DC5V
Dimensions (H × W × D) (mm)	145 × 90 × 30	-*	145 × 90 × 30
Weight (g)	150	140	150

DC 5 V is supplied the indoor unit.

\*It will replace the parts of the indoor unit to be connected.

# WLAN adapter

UTY-TFSXH3 / UTY-TFSXJ3



USB type for single split models  
UTY-TFSXH3



UTY-TFSXJ3  
(CN connector type)

Up to  
**1** indoor units



## AIRSTAGE Mobile

“AIRSTAGE Mobile” is an application software that enables you to manage the Fujitsu General's air conditioner(s) with a mobile device from anywhere.

- Maximum 5 accounts per 1 indoor unit
- Room / Outdoor temperature display
- Can be used for a Single / Multi and VRF indoor units.
- No separate external power supply required
- “AIRSTAGE Mobile” is an application software that enables you to operate the Fujitsu General's air conditioners with a mobile device.

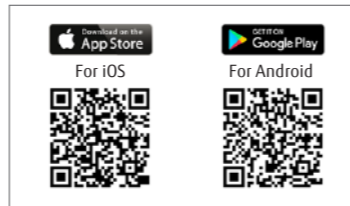

### User Friendly for Everyone

Enjoy easy-to-use centralized operation of air conditioners via a smartphone anytime, anywhere



Image\*



House Owner



Shop Owner



Commercial Building Owner

### Main Functions

- ON / OFF
- Operation mode
- Fan speed
- Louver position
- Set temperature control
- Weekly timer
- Room temperature display
- Outdoor temperature display
- Error display

\*Contents of display differ depending on the type of indoor unit.

### New Design!

Ease of use is pursued to achieve a stylish design.

The more legible and accessible timer UI enables effortless schedule management.



Mode change



Fan speed change



Weekly timer

### Features: AIRSTAGE Mobile

#### Centralized operation for flexible remote management of all air conditioners

AIRSTAGE Mobile is ideal for a wide range of applications, from large residential buildings to smaller commercial spaces such as offices and stores. Anyone who has a smartphone and an adapter can easily manage the system at a low cost.

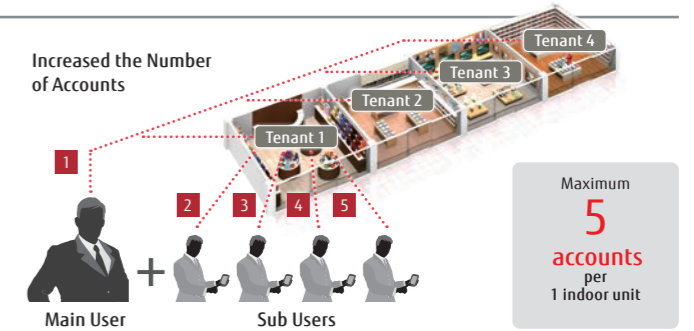

#### Hierarchical group management

Multiple air conditioners can be combined into a single group for centralized operation. Several groups can also be organized at once. Grouping the air conditioners by building, floor, or room makes it easy for users to monitor their operation status and operate them quickly.

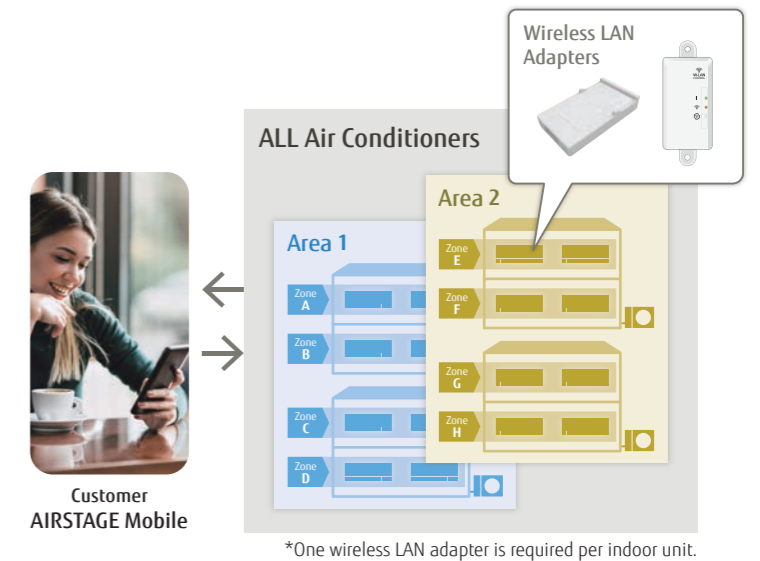
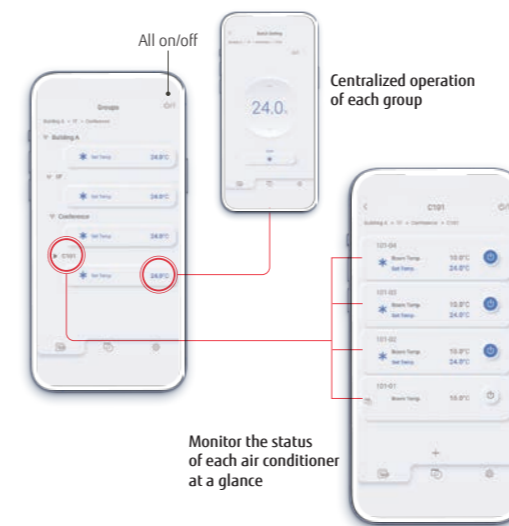

\*One wireless LAN adapter is required per indoor unit.

#### Operate air conditioner and check its operation status just by talking to it

Connecting with a smart speaker allows the user to operate the air conditioner and check its operation status just by talking to it.

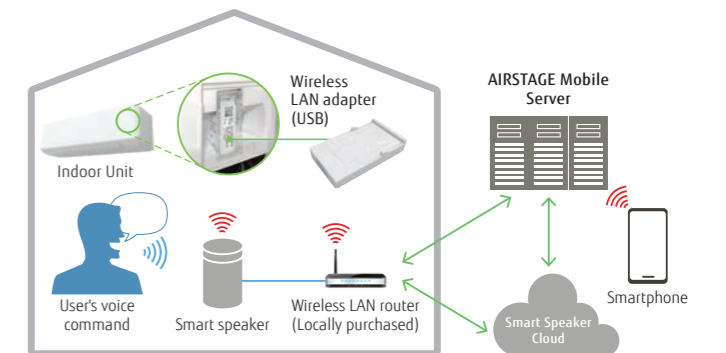

\* The new WLAN adapters for AIRSTAGE Mobile are upper compatible for the indoor units that can connect the following WLAN adapters for FGLair.

	CN connector type	USB type
for FGLair	UTY-TFSXZ1	UTY-TFSXF2
for AIRSTAGE Mobile	UTY-TFSXJ3	UTY-TFSXH3

#### Specifications

Model name	UTY-TFSXJ3(CN connector type)	UTY-TFSXH3
Dimensions (H × W × D) (mm)	71 × 38 × 15	56.7 × 34 × 9.72
Weight (g)	35	30

# WLAN adapter

UTY-TFNXZ1 / UTY-TFSXZ1 / UTY-TFSXF2



USB type for single-split models  
UTY-TFSXF2



UTY-TFNXZ1  
(3-wire RC-line type)  
UTY-TFSXZ1  
(CN connector type)

Up to  
**1** indoor units



- This interface provides the most advanced solution for the remote management of an air conditioning system by using smartphones, tablets, and computers.
- No separate external power supply required
- Can be used for a Single / Multi and VRF indoor units.

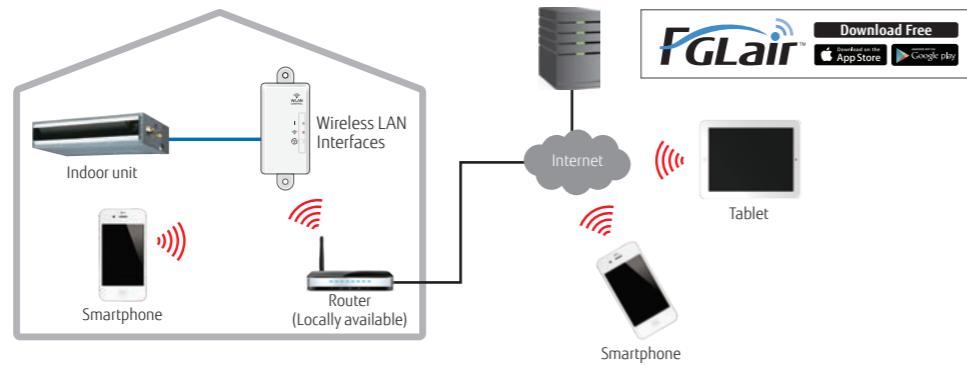

## Basic control

- Turning the units on and off
- Mode control (Heat, Cool, Dry, Auto, Fan)
- Fan speed control
- Louver position (airflow direction setting)
- Timer operation setting (Weekly timer)
- Economy mode setting

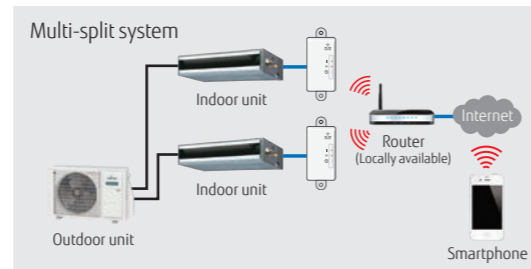

## Multiple air conditioning management

- Manage multiple air conditioning systems in different locations.

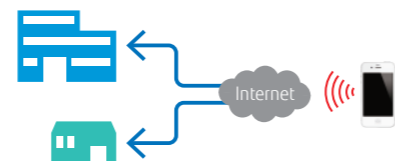

## Error alert and e-mail notice

- E-mail notification alerts
- Air conditioning malfunction alert
- Enables quick service response when errors occur.

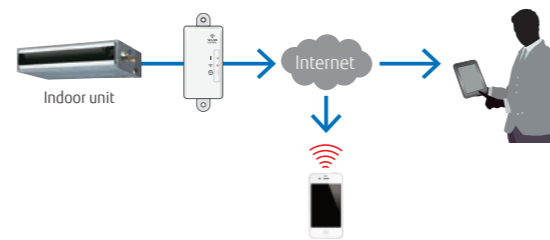

## WLAN adapter (USB type) UTY-TFSXF2

A compact USB type is available. No need for specialized installation. Easily installed on the indoor unit.



### Specifications

Model name	UTY-TFNXZ1 (3-wire RC-line type)	UTY-TFSXZ1 (CN connector type)	UTY-TFSXF2
Dimensions (H × W × D) (mm)	71 × 38 × 15	71 × 38 × 15	56.7 × 34 × 9.72
Weight (g)	35	35	30

# WLAN adapter

FG-RC-WIF1Z2 / FG-IR-WIF1Z1 / FG-AC-WIF1Z1



FG-RC-WIF1Z2  
(3-wire RC-line type)



FG-AC-WIF1Z1  
(CN connector type)



FG-IR-WIF1Z1  
(IR type)

Up to  
**1** indoor units

## AC Cloud Control

- This interface provides the most advanced solution for the remote management of an air conditioning system by using smartphones, tablets, and computers.
- No separate external power supply required

## Installation example

[3-wire RC-line type/CN connector type]

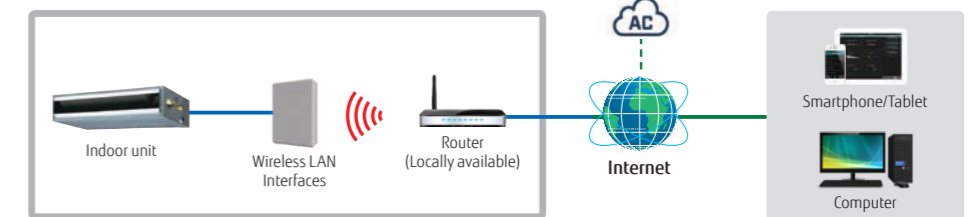

[IR type] Connection to wall-mounted type

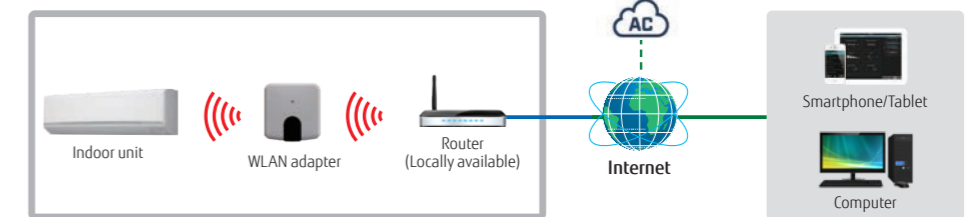

[IR type] Connects to the product with the optional receiver kit

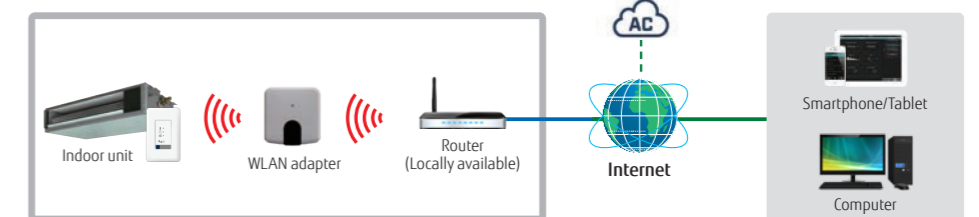

\*IR receiver required.

## Basic control

- Turning air conditioner on and off
- Mode select (Heat, Cool, Dry, Auto, Fan)
- Louver position (airflow direction setting)
- Fan speed control
- Room temperature display
- Setting temperature
- Multiple language support
- One single scene is created.

## Advanced control (optional functions)

- Climate-based operation modes (ECO, Comfort, and Powerful) (to be available in the future)
- Schedule functions (ON/OFF, modes, set temperature, fan speed, louver position)
- Setting temperature range limitation
- Multiple Scenes and Calendars are created.
- Smart Speaker compatibility
- Advanced internet service connections

## Notification and operation history

- E-mail notification alerts
- Air conditioning malfunction alert
- Connectivity monitoring and alert
- Operation history (to be available in the future)

### Specifications

Model name	FG-RC-WIF1Z2 (3-wire RC-line type)	FG-AC-WIF1Z1 (CN connector type)	FG-IR-WIF1Z1 (IR type)
Number of controllable groups	1	1	1
Dimensions (H × W × D) (mm)	108 × 70 × 28	81 × 78 × 28	127 × 50 × 17
Weight (g)	80	76	80

# Multiple protocol WLAN adapter

FG-RC-WMP1Z1 / FG-IR-WMP1Z1 / FG-AC-WMP1Z1



**Intesis**  
BY HBS NETWORKS



FG-RC-WMP1Z1  
(3-wire RC-line type)

**Intesis**  
BY HBS NETWORKS



FG-AC-WMP1Z1  
(CN connector type)

**Intesis**  
BY HBS NETWORKS



FG-IR-WMP1Z1  
(IR type)

Up to  
**1** indoor units

### Specifications

Model name	FG-RC-WMP1Z1 (3-wire RC-line type)	FG-AC-WMP1Z1 (CN connector type)	FG-IR-WMP1Z1 (IR type)
Number of controllable groups	1	1	1
Dimensions (H × W × D) (mm)	70 × 100 × 28	127 × 50 × 17	81 × 78 × 28
Weight (g)	98	80	76

# Multiple protocol LAN adapter

FG-TL-MBS16Z1



**Intesis**  
BY HBS NETWORKS



FG-TL-MBS16Z1  
(VRF type)

Up to  
**16** indoor units

### Specifications

Model name	FG-TL-MBS16Z1 (VRF type)
Power supply	9 to 36 V DC, Max.: 140 mA or 24 V AC 50/60 Hz, Max.: 127 mA.*
Input power (W)	1.7
Dimensions (H × W × D) (mm)	90 × 88 × 56
Weight (g)	330

\*24 V DC power supply is recommended.

## AC Cloud Control

- Air conditioner control of Home Automation systems via wireless LAN connection.
- No separate external power supply required

### Installation example

[3-wire RC-line type/CN connector type]

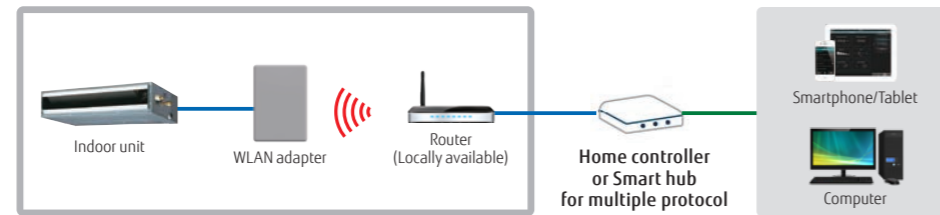

[IR type]

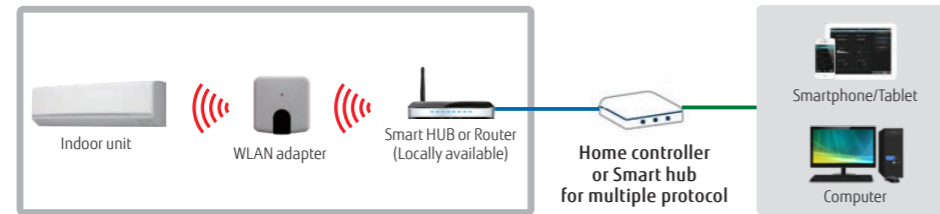

\*IR receiver required for other than wall-mounted type.

# Home central remote controller

UTY-DMMYM / UTY-DMMYM1



Up to  
**1** multi-split system  
Up to  
**6** indoor units

## For 5-unit and 6-unit multi-split type

- Batched control of up to 6 indoor units For all indoor units connected to the remote controllers, the Home central remote controller sets room temperature, airflow volume, and remote controller prohibition from other remote controllers at once.
- Supports 9 languages: English, French, German, Greek, Italian, Portuguese, Russian, Spanish, and Turkish.
- Large backlit LED screen
- Large, easy-to-see operation panel

### Example of system configuration

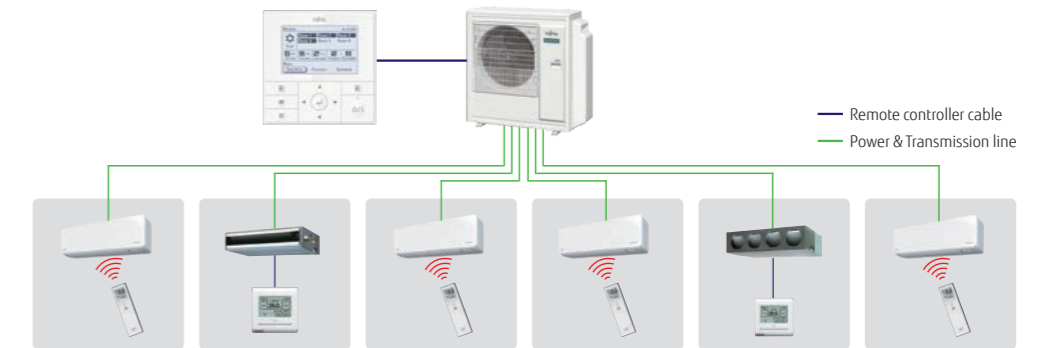

## Home central remote controller

### Weekly timer

Up to 4 ON/OFF settings can be programmed per day. Two weekly patterns can be set, one for the cooling season and the other for the heating season.

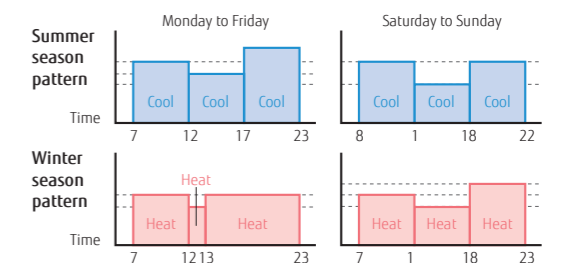

### Low noise operation

You can choose from 4 low noise levels depending on the installation environment. ON/OFF timing of low noise mode can be set with the timer.

### 10°C heat operation

When you leave the house, the air conditioner runs a minimum heating operation to maintain the room temperature at 10°C.

\*Consult your dealer for conditions of use.

### Economy operation

When you select energy-saving economy mode, the temperature setting for the indoor unit increases (during cooling operation) or decreases (during heating operation) by 1°C and the maximum electric value of the outdoor unit is suppressed.

### Prohibiting local control, including settings such as child lock

The Home central remote controller is equipped with a lock function to prevent unauthorized operation from the remote controllers of the indoor unit in each room. The Home central remote controller is equipped with a child lock to prevent children from accidentally turning the air conditioner on or off or changing its settings.

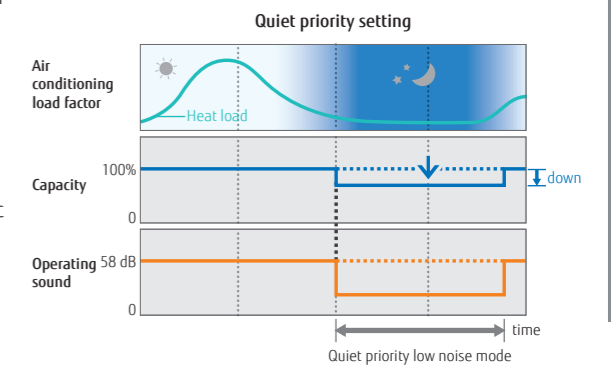

### Specifications

Model name	UTY-DMMYM/UTY-DMMYM1
Power source	12 V DC
Dimensions (H × W × D) (mm)	120 × 120 × 21.3
Weight (g)	220

12 V DC supplied by an indoor unit

# Central remote controller

UTY-DCGYZ3



NEW



Up to 100 indoor units  
Up to 50 groups

## For tenants in small to midsize commercial premises

- Individual control and monitoring of up to 100 indoor units
- 7.0inch TFT color screen
- Visually intuitive operation
- Room temperature display by indoor unit sensor & remote controller sensor
- 50 Remote Controller Groups Display & remote controller group rename
- Supports 14 languages: Chinese (Simplified/Traditional), Dutch, English, French, German, Greek, Italian, Polish, Portuguese, Russian, Spanish, Turkish, and Thai (Remote Management only)

## Easy operation

### Air conditioning management by detecting room temperatures of each room

The room temperature detected with indoor unit sensor or remote controller sensor can be displayed. New model can detect the room temperature by indoor units sensors even if wired remote controllers are not connected to the indoor units.

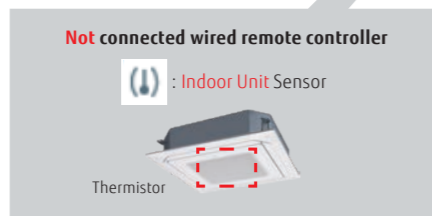

\*Room temperature is displayed only when indoor unit operates.

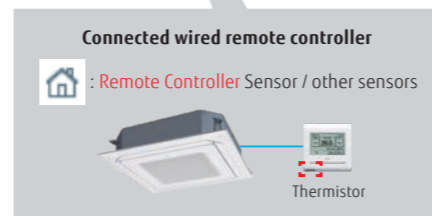

## 50 Remote Controller Groups Display

The group display and the 50 remote controller groups display can be switched easily. Users can choose which display is better, depending on the situation.

### Group Display



Manage & Monitor by each Groups

### 50 Remote Controller Groups Display

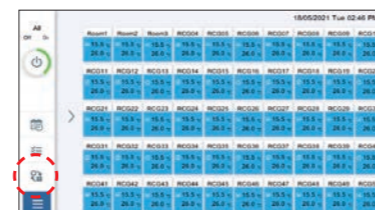

Manage & Monitor by 50 Remote Controller Groups



## Remote Controller Groups Rename

The remote controller group names can be changed. Users can know easily where the air conditioning is located by changing the remote controller group names.



## Features: Central Remote Controller

- Easy intuitive operation from the touch panel display.
- All functions can be accessed through the monitoring screen showing a pop-up window for detailed operation.

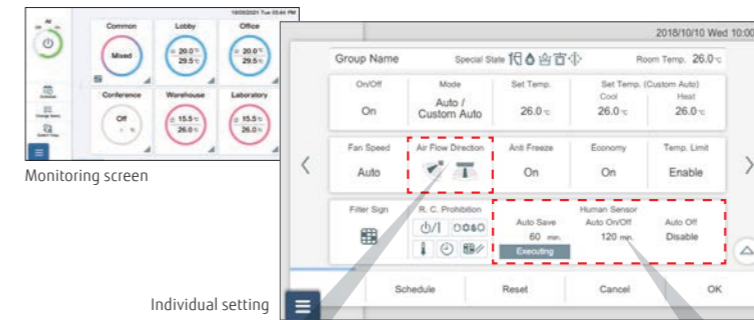

**Added individual wind direction control**  
Individual wind direction control has been added.  
Circular Flow cassette / 3D Flow cassette

**Human sensor Compatible**  
**Human sensor setting**

- Auto save
- Auto on / off
- Auto off detection time
- Enable and disable

## Remote Management

### Remote monitoring / Remote operation

New central remote controller can control your tenant's air conditioner anytime and anywhere.

When the central remote controller manages the indoor units of some tenants, air conditioning of each tenant can be managed separately online.

### Increased the Number of Accounts

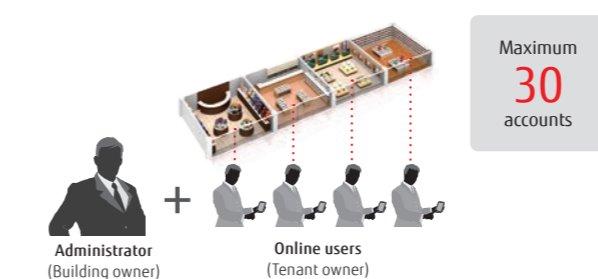

### Trouble support function

#### Display error details

Display descriptive explanation when an error occurs



### Sensor value monitoring function

Monitor sensor data of indoor unit / outdoor unit, send mail

### Notify room temperature by email\*

Notify by e-mail when the temperature around the air conditioner is too high or too low

\*:This function is available only when using wired remote controller.

## Schedule management

### Annual schedule

- An annual schedule can be arranged for each remote controller group or user-defined group.
- Allows for the programming of special settings for weekends, holidays, and store closings throughout the year.

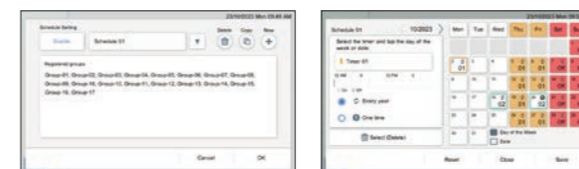

### low noise schedule

Low noise operation of outdoor units can be scheduled.



### Automatic return to set temperature

A function that automatically returns the changed temperature to its original value over time.

## Specifications

Model name	UTY-DCGYZ3
Power Supply	100-240 V 50/60 Hz
Dimensions (H × W × D) (mm)	134.6 × 216.2 × 37.9
Weight (g)	800

# Touch panel controller

UTY-DTGYZ1



- Large 7.5-inch TFT color LCD screen
- Touch screen operation
- Stylish design to fit nicely into any room environment
- Controls up to 400 indoor units.
- Icon or list view can be selected in monitoring mode.
- Supports 7 languages: Chinese, English, French, German, Polish, Russian, and Spanish.
- Mounted with LAN adapter for remote control & operation, external input/output with emergency stop and batch ON/OFF

Up to  
**400** indoor units  
Up to  
**100** outdoor units  
Up to  
**400** groups

## Easy operation

- Wide range of simple-to-understand icons
- Operate by pressing the icons on the screen with your finger or a stylus.
- The color on the back identifies the current control operation; blue is for monitoring and green is for operational control.

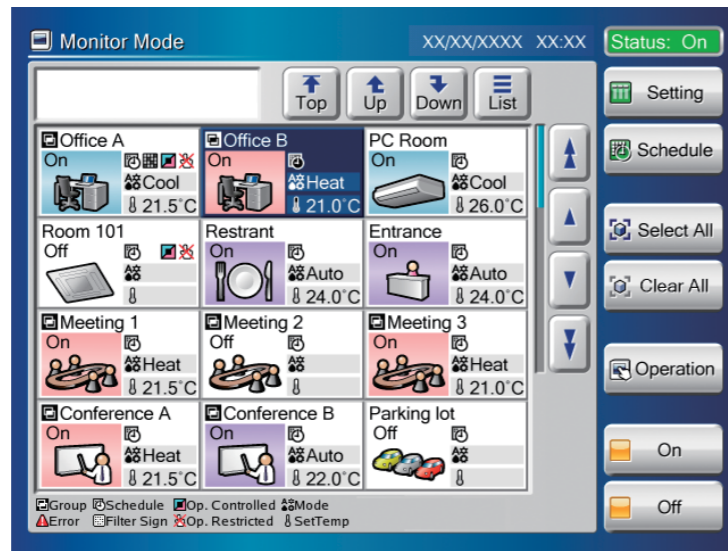

## Easy maintenance

- The flat touch panel can be easily cleaned.
- Touch panel controller with non-glare coating to prevent finger marks
- Front cover for easy removal.



## Easy installation

- The touch panel controller can be mounted on a wall.
- Flat back surface enables easy installation anywhere on a wall.
- No additional parts or components required for installation



## Controls up to 400 indoor units.

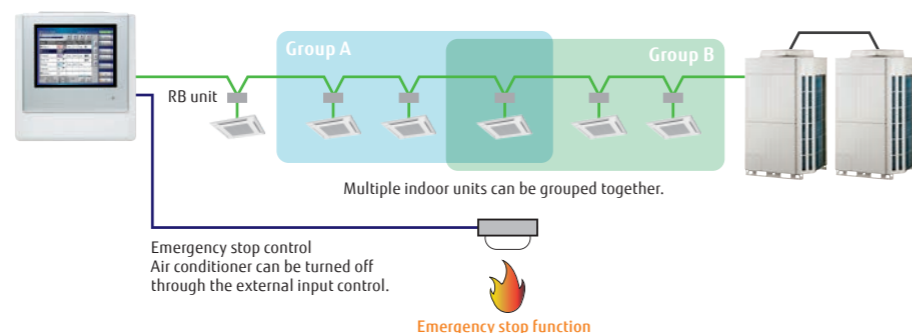

## Features:

### Control & monitoring

- Control and monitor Fujitsu General air conditioners via LAN or internet.
- Users and tenants can manage their assigned equipment from anywhere by computer or tablet.
- When something goes wrong, an error notice is sent by e-mail for prompt troubleshooting.

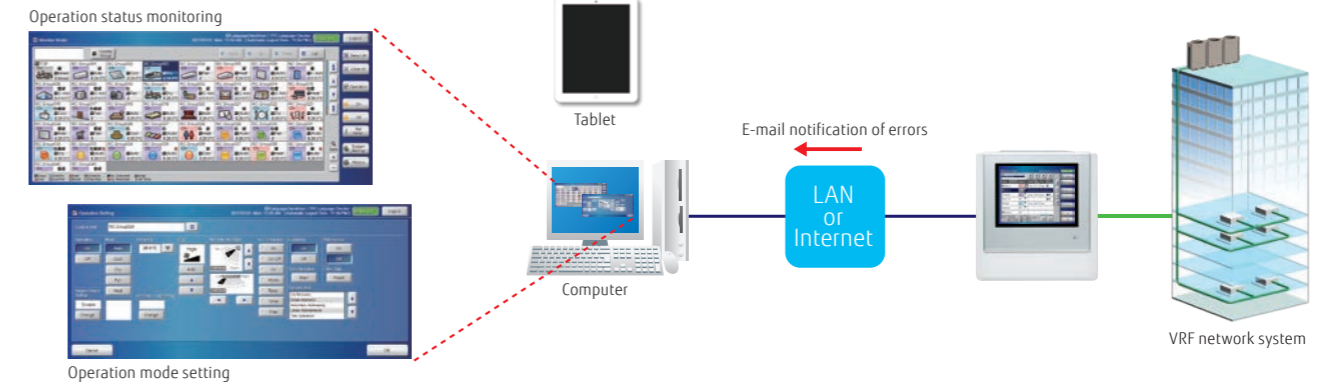

### Smartphone

Model name	Browser
Nexus 6P (Android 7.1.1)	Google Chrome 5.5
iPhone 7 (iOS 10.1)	Safari 10

### Tablet

Model name	Browser
iPad Pro 9.7 inch (iOS 10.2.1)	Safari 10

## Flexible access permissions can be granted to users at each point level.

The administrator can register multiple users and permit them to access any indoor unit and any functions.

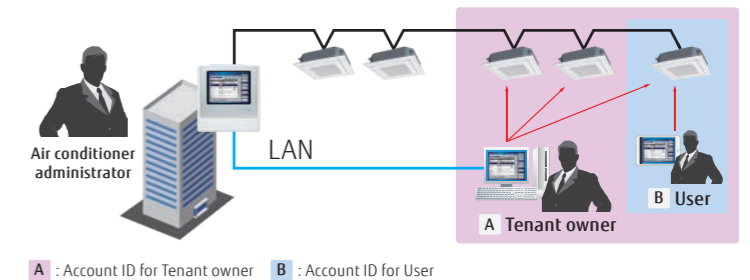

A : Account ID for Tenant owner B : Account ID for User

## Additional languages

Supports 7 languages as standard: Chinese, English, French, German, Polish, Russian, and Spanish. Create a language database to integrate additional languages into the remote device. The added languages will only be displayed on the remote device and cannot be added to the Touch panel controller.

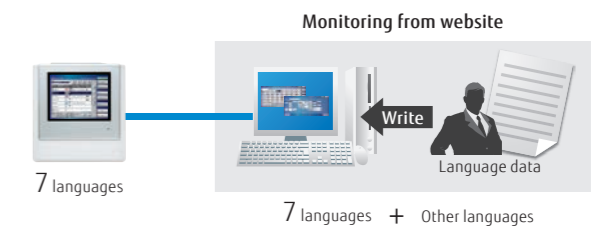

## Electricity charge apportionment (Option: UTY-PTGXA)

- Energy cost can be calculated and allocated to each billing user in proportion to the amount of energy used for air conditioning.

- Apportionment charge/bill calculation
- Tenant (block) setting
- Common facilities apportionment setting
- Rated power consumption allotment
- Individual calculations for cooling and heating
- Electricity meter supported

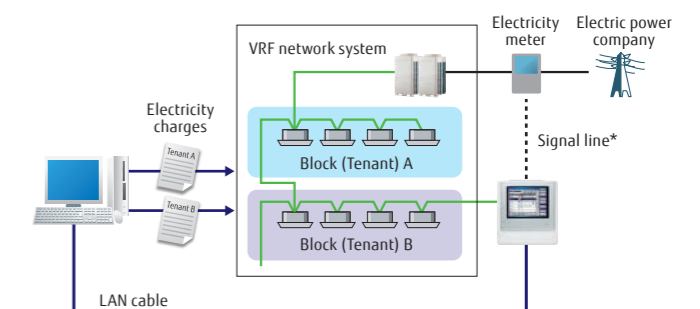

\* An electricity usage meter can be connected to an external input connector of the Touch panel controller. In that case, the meter cannot be connected to an outdoor unit at the same time.

Features:

### Automatic setting for daylight saving time

Functions provided

- 1) Schedule setting for daylight saving time
  - It prevents the user from forgetting to set daylight saving time. In addition, it saves time and effort for the user.

Automatic clock adjustment

- 2) Time can be set for all controllers in a batch automatically.

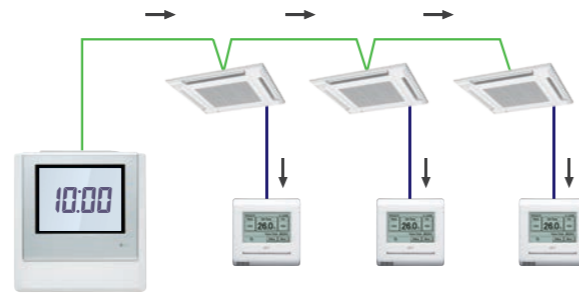

### Outdoor unit low noise operation

You can choose from 4 low noise levels depending on the installation environment. ON/OFF timing of low noise mode can be set with the timer.

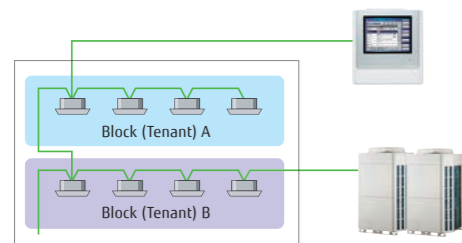

Quiet priority setting

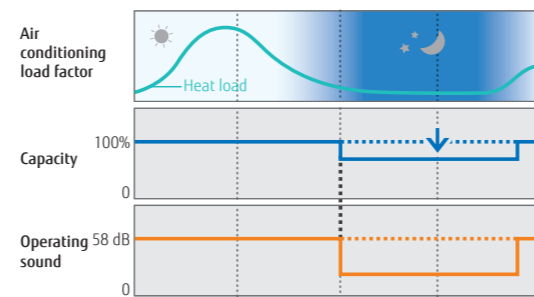

### Energy-saving controls

Custom Auto

- Maintains 2 separate setpoints for heating and cooling operations.
- Automatically switches between heating and cooling modes.

\* Not available for some models



Cooling set temp. 28°C, Heating set temp. 18°C

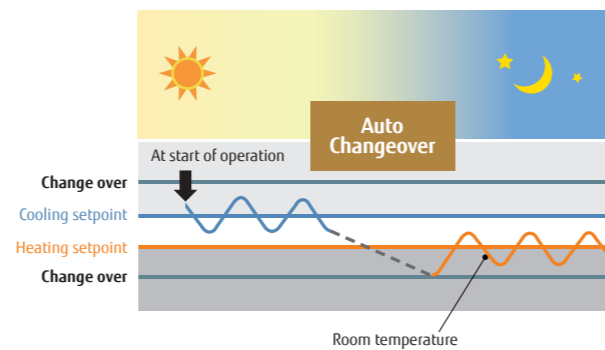

### Refrigerant leak detector

Refrigerant leakage status is indicated by the management equipment. A pop-up message is displayed to notify the user, and the refrigerant is shut off.



Pop-up highlighting

### FUNCTIONS SUMMARY

	UTY-DTGYZ1	Monitoring side
<b>Air conditioning control functions</b>		
ON/OFF	●	●
Operation mode setting*	●	●
Fan speed control	●	●
Room temperature setting	●	●
Setting temperature range limitation	●	●
Test operation	●	●
Vertical louver setting	●	●
Horizontal louver setting	●	●
Individual louver control	●*1	●
Group setting	●	●
Remote controller prohibition	●	●
Anti-freeze setting	●	●
Set temperature auto return	—	●
Energy-saving controls	—	●
Economy mode setting	●	●
Human sensor control	—	●
<b>Displayed items</b>		
Error	●	●
Defrosting	●	●
Current time	●	●
Day of week	●	●
Remote controller prohibition	●	●
Cooling/heating priority	●	●
Address display	●	●
Room temperature	●*3	●*3
Multiple language support	●	●
Setting for daylight saving time	●	●
Time zone setting	●	●
Name registration	●	●
Backlighting	●	●
Language setting	7	7+ other
Filter sign reset	●	●
Memory operations	●	●
Refrigerant leak detector	●	●

●: Supported ○: Optional function —: Not supported  
 \*1 Only setting cancellation can be operated.  
 \*2 Only available for external input control.  
 \*3 Available only when using a Wired remote controller.

### Specifications

	UTY-DTGYZ1
Model name	UTY-DTGYZ1
Power supply	Single phase ~100 to 240 V 50/60 Hz
Dimensions (H × W × D) (mm)	260 × 246 × 54
Weight (g)	2,150
Interfaces	Transmission/LAN/USB/EXT IN/EXT OUT/Reset SW

	UTY-DTGYZ1	Monitoring side
<b>Timer</b>		
	Period	Year
Schedule timer	ON/OFF, Temp, Mode, Times per day	20
		Year
ON/OFF timer	—	—
Sleep timer	—	—
Program timer	—	—
Auto-off timer	—	●
Day off	●	●
Minimum unit of timer setting (minutes)	10	10
<b>Control</b>		
Remote monitoring management system	●	●
Electricity charge apportionment	○	○
Error history	●	●
Emergency stop	●*2	●*2
Remote monitoring management	—	●
Energy-saving management	—	—
E-mail notification in case of failure	—	●
Key lock	● Password setting	—
Low noise mode	●	●



# System controller

UTY-APGXZ1 **Software**

Up to  
**4** VRF network systems  
Up to  
**400** outdoor units  
Up to  
**1,600** indoor units

System controller enables advanced integrated monitoring and control of VRF network systems operating in small to large buildings.

- Up to 1,600 indoor units and 400 outdoor units on up to 4 VRF network systems can be controlled.
- To accommodate facility management needs, the system controller offers—in addition to precise air conditioning control—remote central control, electricity charge apportionment, schedule management, and energy-saving options for VRF network systems.
- Supports 7 languages: Chinese, English, French, German, Polish, Russian, and Spanish.



# System controller lite

UTY-ALGXZ1 **Software**

Up to  
**1** VRF network systems  
Up to  
**100** outdoor units  
Up to  
**400** indoor units

System controller Lite offers a set of standard functions to manage air conditioners operating in a small or midsize building.

- Up to 400 indoor units and 100 outdoor units on a VRF network system can be controlled.
- In addition to precise air conditioning control, a variety of applications are available as options to offer a wider range of control.
- Supports 7 languages: Chinese, English, French, German, Polish, Russian, and Spanish.



## Visually intuitive operation

**Click & Operate:** The visual representation of the property is shown on the screen from the perspective most suitable for operation (Click & Operate) You can select from among 4 display options: site, building, floor, and list.

**Freely define groups for batched control:** Indoor units can be grouped for simplified batch control from the tree menu. They can be grouped by organizational hierarchy, such as by division, department, and section.

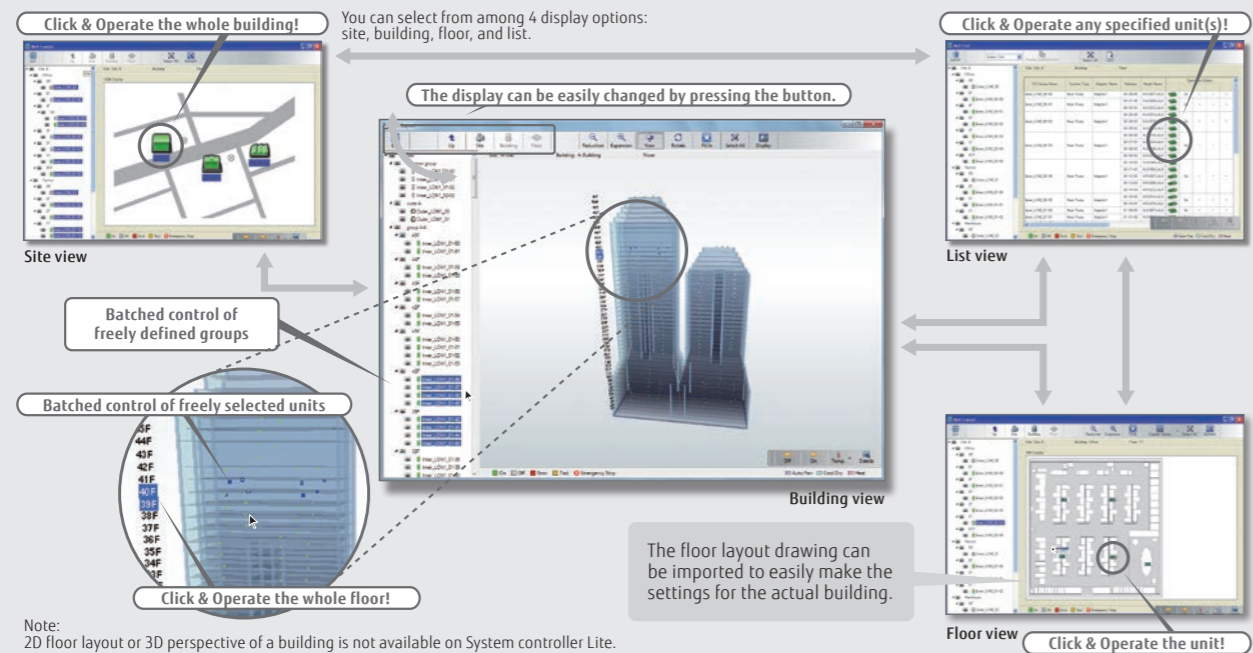

Note: 2D floor layout or 3D perspective of a building is not available on System controller Lite.

## Features:

### Third-party devices connected via MODBUS® can be controlled.

**Standard** for System Controller **Option** for System controller Lite UTY-PLGXX2

When a MODBUS® adapter (locally available) is connected to a computer, electrical equipment and devices supported by MODBUS® can be monitored and controlled centrally from the computer. The central control can reduce wasted energy throughout an entire building resulting from a failure to turn equipment off during or after work, as well as reduce the need for on-site patrols.

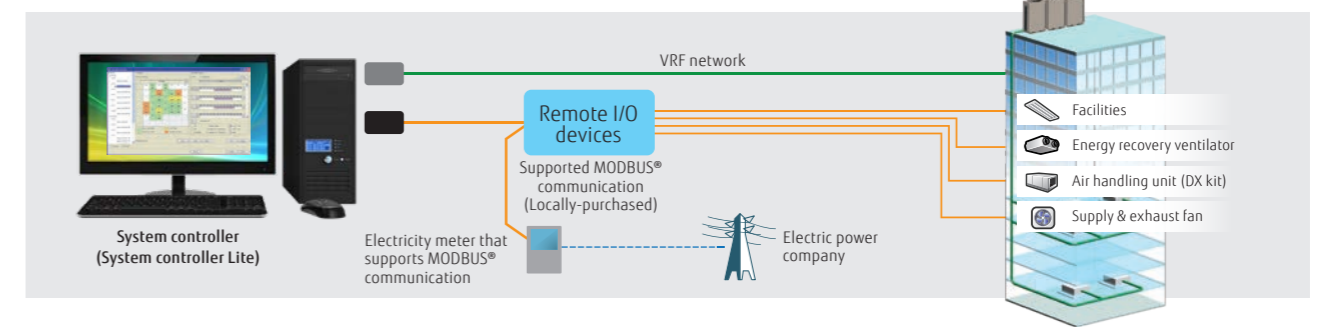

## Wide-ranging operation and data management

**Standard** System controller and System controller Lite

### Schedule management

- An annual schedule can be arranged for each remote controller group or user-defined group.
- ON/OFF, operation mode, remote controller prohibition, and temperature settings can be programmed for up to 143 times per day at 10-minute intervals and for up to 101 configurations for each remote controller group.
- Settings can be programmed for a period that spans midnight.
- Allows for the programming of special settings for weekends, holidays, and store closings throughout the year.
- Low noise operation of outdoor units can be scheduled.

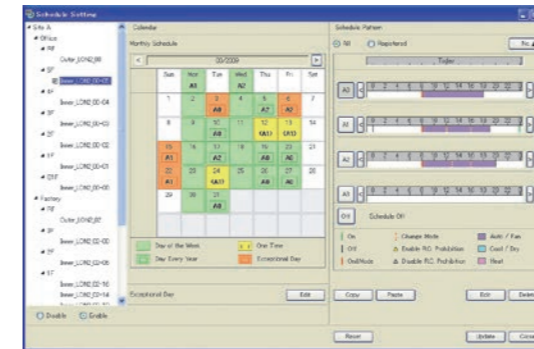

### Wide-ranging control of indoor and outdoor units

- The operation status and mode of each indoor unit are displayed.
- Turn on and off each indoor unit and switch its operation mode.
- Setting temperature range limitation
- Low noise setting of outdoor units

### Remote controller prohibition

Prohibits the operation mode, temperature setting, or ON/OFF of an indoor unit.

### Error alert and e-mail notice

When something goes wrong, an error message is shown in a popup on a computer display with a chime, and an e-mail notice is sent. Errors of the past one year are logged and can be reviewed.

### Operation and control history

A history of operation status and control can be maintained and retrieved.

### Importing and exporting databases

Only an administrator is authorized to import and export registration, layout, and image data.

### Automatic clock adjustment

Time can be set for all controllers in batch automatically.

## Electricity charge apportionment

**Standard** on System controller  
**Option** System controller Lite UTY-PLGXA2

### Electricity charge apportionment method

This is a method to calculate monthly energy costs to be allocated to each tenant based on the amount of energy used by their air conditioners. The first step is to determine exactly how much energy is consumed by air conditioners in each tenant space. The second step is to divide the total energy charge billed by an electric power company based on the amount of energy used by each tenant to determine the energy cost to be allocated to each of them. (See figure on right) The calculation takes into consideration such factors as the number of unused rooms and nighttime electricity rate, which are shown in detail on an energy cost allocation schedule.

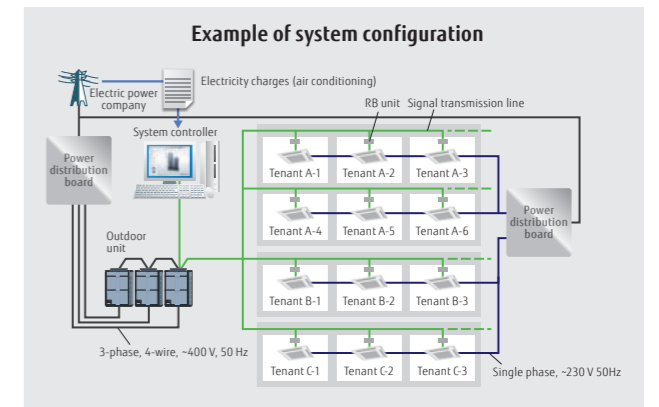

Features:

### Remote monitoring management

- Standard** on System controller
- Option** System controller Lite UTY-PLGXR2

The System controller can be used on site or remotely over networks for remote central control. The System controller requires 2 software programs working together: The VRF controller runs on site and communicates with the VRF system; The VRF explorer, which runs at a remote location, provides a user interface and communicates with the VRF controller. The VRF controller and the VRF explorer run on a single computer or on different computers connected on a network. A computer running VRF explorer can centrally control up to 10 VRF system sites having up to 20 buildings each.

#### On site central control

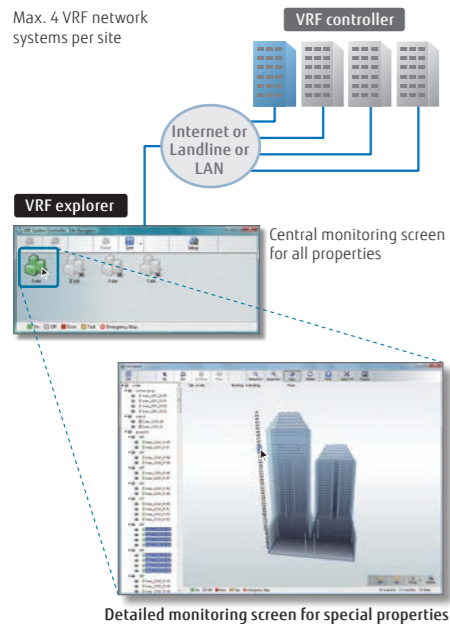

#### Remote central control

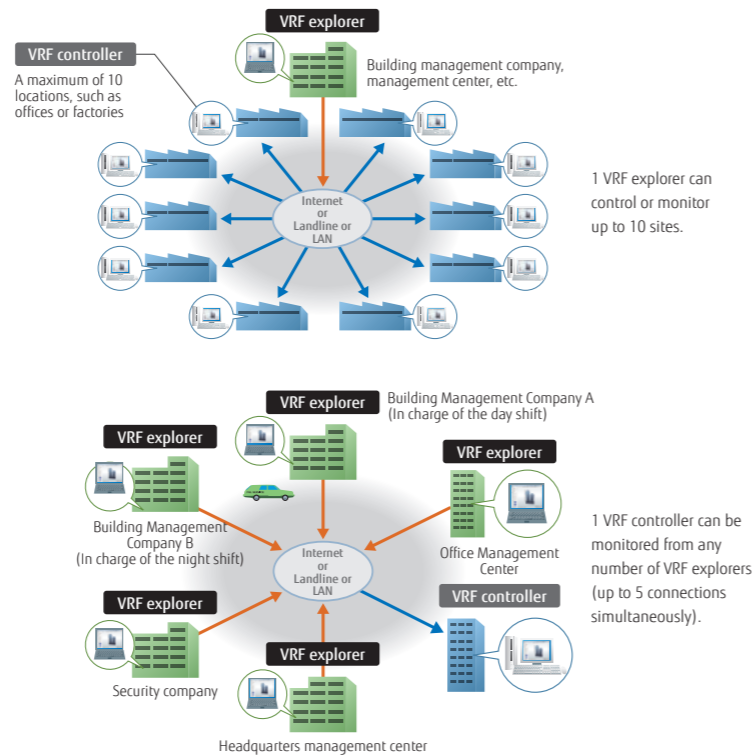

### Energy-saving management

- Option** System controller UTY-PEGXZ1
- Option** System controller Lite UTY-PLGXE2

A variety of energy-saving options can be selected depending on the season, weather, and time of day. Excellent energy-saving operation is performed while keeping users comfortable.

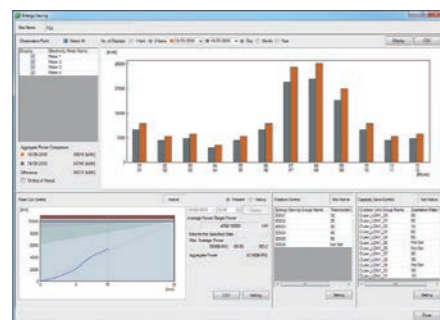

Main screen for energy-saving management

Energy saving graph data: This chart compares the energy consumption for the current month with the previous month and with the same month of the previous year to keep track of the energy-saving performance.

#### Indoor unit rotation

Indoor units can be automatically rotated to operate within a group in accordance with a predetermined annual schedule to reduce power consumption while keeping users comfortable. The operation stoppage rate can be selected for an indoor unit.

#### Peak-cut mode

The system controller monitors the connected power meter and controls the energy to maintain the target power consumption set for each time period by changing the set temperature of the indoor units or turning off the thermostat so as to keep the users comfortable. Indoor units to be controlled can be grouped in many ways, and the control level can be set for each group.

#### Capacity saving for outdoor unit

The upper limit on the capacity of an outdoor unit can be adjusted to reduce power consumption during a hot summer or cold winter by averaging out the power-saving performance of each refrigerant system. The upper limit on capacity can be set at 50% of the rated capacity or more.

### Summary of functions

Functions	Type	System controller		System controller Lite				
		UTY-APGXZ1	Option UTY-PEGXZ1	UTY-ALGXZ1	Option UTY-PLGXR2	Option UTY-PLGXA2	Option UTY-PLGXE2	Option UTY-PLGXX2
Specifications	Max. number of VRF networks supported	4	—	1	—	—	—	—
	Max. number of indoor unit and remote controller groups per VRF network	400	—	400	—	—	—	—
	Max. number of outdoor units per VRF network	100	—	100	—	—	—	—
	Max. number of indoor units and remote controller groups per System controller	1600	—	400	—	—	—	—
Site supervision	Multiple site display	10	—	10	—	—	—	—
	Number of buildings per site	20	—	—	—	—	—	—
	Number of floors per site	200	—	—	—	—	—	—
	Number of floors per building	50	—	—	—	—	—	—
	3D graphical layout view	●	—	—	—	—	—	—
	2D graphical layout view	●	—	—	—	—	—	—
	List display	●	—	●	—	—	—	—
Error management	Error notification	●	—	●	—	—	—	—
	Audible alarm	●	—	●	—	—	—	—
	E-mail notification of errors	●	—	●	—	—	—	—
History	Error history	●	—	●	—	—	—	—
	Operation history	●	—	●	—	—	—	—
Operation control	Individual control	ON/OFF	●	—	●	—	—	—
		Operation mode*	●	—	●	—	—	—
		Room temperature	●	—	●	—	—	—
		Fan speed	●	—	●	—	—	—
		Airflow direction	●	—	●	—	—	—
		Economy mode	●	—	●	—	—	—
	Individual management	Setting temperature range limitation	●	—	●	—	—	—
		Anti-freeze	●	—	●	—	—	—
		Low noise setting of outdoor units	●	—	●	—	—	—
	Other	Remote controller prohibition	●	—	●	—	—	—
		Setting temperature range limitation	●	—	●	—	—	—
		Filter sign reset	●	—	●	—	—	—
		memory operations	●	—	●	—	—	—
Schedule	Annual Schedule	Pattern operations	●	—	●	—	—	
		Annual Schedule	●	—	●	—	—	
	Setting for a specific date	●	—	●	—	—	—	
	ON/OFF per day	72	—	72	—	—	—	
	ON/OFF per week	504	—	504	—	—	—	
	Day off	●	—	●	—	—	—	
	Minimum unit of timer setting (minutes)	10	—	10	—	—	—	
Remote monitoring management	Weekly schedule for low noise mode	●	—	●	—	—	—	
	Web Operation	●	—	●	—	—	—	
	Remote monitoring	●	—	●	—	—	—	
	Remote operation control	●	—	●	—	—	—	
Electricity charge apportionment	Remote function setting	●	—	●	—	—	—	
	Apportionment charge/bill calculation	●	—	●	—	—	—	
	Tenant (block) setting	●	—	●	—	—	—	
	Common facilities apportionment setting	●	—	●	—	—	—	
Energy-saving management	Rated power consumption allotment	●	—	●	—	—	—	
	Individual calculations for cooling and heating	●	—	●	—	—	—	
	Electricity meter supported	●	—	●	—	—	—	
	Indoor unit rotation	●	—	●	—	—	—	
Control of external devices	Peak cut control	●	—	●	—	—	—	
	Capacity saving for outdoor unit	●	—	●	—	—	—	
	Record of energy-saving operation	●	—	●	—	—	—	
	Information on energy saving	●	—	●	—	—	—	
Others	Power consumption monitor	●	—	●	—	—	—	
	Electricity meter supported	●	—	●	—	—	—	
	Monitor	●	—	●	—	—	—	
	Control	●	—	●	—	—	—	
Importing and exporting databases	Importing and exporting databases	●	—	●	—	—	—	
	Automatic clock adjustment	●	—	●	—	—	—	
	Multiple language support	7 languages	—	7 languages	—	—	—	
	Refrigerant leak detector	●	—	●	—	—	—	
Power shutdown	●	—	●	—	—	—		

●: Available - : Not available

### Computer requirements

The specifications required for the computer are shown in the table below:

	System controller	System controller Lite
<b>Operating system</b>	<ul style="list-style-type: none"> <li>Microsoft® Windows® 7 Home Premium (32-bit or 64-bit) SP1, Windows® 7 Professional (32-bit or 64-bit) SP1</li> <li>Microsoft® Windows® 8.1 (32-bit or 64-bit), Windows® 8.1 Pro (32-bit or 64-bit)</li> <li>Microsoft® Windows® 10 Home (32-bit or 64-bit), Windows® 10 Pro (32-bit or 64-bit)</li> </ul> Supports 7 languages: English, Chinese, French, German, Russian, Spanish, and Polish	<ul style="list-style-type: none"> <li>Microsoft® Windows® 7 Home Premium (32-bit or 64-bit) SP1, Windows® 7 Professional (32-bit or 64-bit) SP1</li> <li>Microsoft® Windows® 8.1 (32-bit or 64-bit), Windows® 8.1 Pro (32-bit or 64-bit)</li> <li>Microsoft® Windows® 10 Home (32-bit or 64-bit), Windows® 10 Pro (32-bit or 64-bit)</li> </ul> Supports 7 languages: English, Chinese, French, German, Russian, Spanish, and Polish
<b>CPU</b>	Intel® Core™ i3 2 GHz or higher	Intel® Core™ i3 2 GHz or higher
<b>Memory</b>	<ul style="list-style-type: none"> <li>2 GB or more (for Windows® 7 [32-bit])</li> <li>4 GB or more (for Windows® 7 [64-bit], Windows® 8.1, and Windows® 10)</li> </ul>	<ul style="list-style-type: none"> <li>2 GB or more (for Windows® 7 [32-bit])</li> <li>4 GB or more (for Windows® 7 [64-bit], Windows® 8.1, and Windows® 10)</li> </ul>
<b>HDD</b>	40 GB or more of free space	40 GB or more of free space
<b>Displayed items</b>	1024 × 768 or higher resolution	1024 × 768 or higher resolution
<b>Interfaces</b>	<ul style="list-style-type: none"> <li>Ethernet port (for getting access to the internet using LAN) or a modem (for getting access to the internet via landline)</li> <li>Up to 6 USB ports</li> <li>(Only required for a server computer working as a VRF controller)</li> <li>- Maximum of 2 USB ports are required to connect to a White-USB-key/WibuKey</li> <li>- Up to 4 USB ports required to connect to an Echelon® U10 USB network interface</li> <li>* Maximum number of required USB ports depends on the applicable system configuration.</li> </ul>	<ul style="list-style-type: none"> <li>Ethernet port (for getting access to the internet using LAN) or a modem (for getting access to the internet via landline)</li> <li>Up to 6 USB ports</li> <li>(Only required for a server computer working as a VRF controller)</li> <li>- Maximum of 4 USB ports are required to connect to a White-USB-key/WibuKey</li> <li>- 1 USB port is required for an Echelon® U10 USB Network interface</li> <li>* The maximum number of required USB ports depends on the applicable system configuration.</li> </ul>
<b>Graphic accelerator</b>	Microsoft® DirectX® 9.0c compatible	Microsoft® DirectX® 9.0c compatible
<b>Software</b>	Adobe® Acrobat Reader® 9.0 or later	Adobe® Acrobat Reader® 9.0 or later

\* Echelon® U10 USB Network interface - TP/FT-10 Channel (Model name: 75010R) (Required for each VRF Network)

### Packing list

Type	For System controller			For System controller Lite			
	System controller	Option Energy manager	System controller Lite	Remote access	Electricity charge apportionment	Energy saving	Centralized control
Model name	UTY-APGXZ1	UTY-PEGXZ1	UTY-ALGXZ1	UTY-PLGXR2	UTY-PLGXA2	UTY-PLGXE2	UTY-PLGXX2
White-USB-key	1	1	1	1	1	1	1

\*1: Software protection key to be inserted in a USB slot running System controller or System controller Lite. System controller or System controller Lite may only run on a PC with a WHITE-USB-KEY. However, a WHITE-USB-KEY is not required for remote VRF explorer software.

# MODBUS® converter for indoor unit

UTY-VMSX



Up to  
1 indoor unit

MODBUS® converter enables air conditioners to be fully integrated into a MODBUS® network.

- Simple installation due to small and compact size.
- No separate external power supply required.
- The MODBUS® converter must be connected to an indoor unit on a one-to-one basis.
- The MODBUS® converter enables central monitoring and control of air conditioners from BMS, central, or home controller.

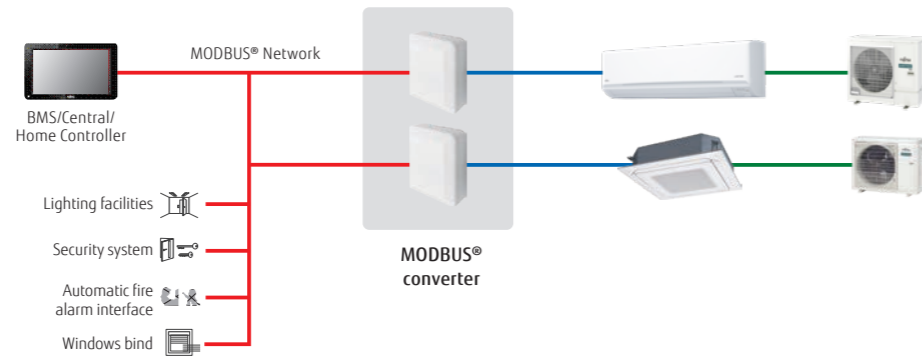

## Easy Installation

Easy to install with minimal wiring and without the need for a power supply cable to the converter

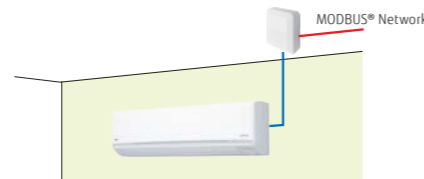

## Basic control

- Turning the units on and off
- Mode control (Heat, Cool, Dry, Auto, Fan)
- Fan speed control
- Louver position (airflow direction setting)
- Room temperature setting and display
- Economy mode setting
- Error status

### Specifications

Model name	UTY-VMSX
Power supply	12 V DC
Input power (W)	Max. 1.2 W
Dimensions (H × W × D) (mm)	140 × 117 × 43
Weight (g)	200
Maximum number of connectable indoor units per MODBUS® converter	1

### Modbus communication specifications

Transfer mode	RTU mode
Communication speed	9600/19200 bps
Data bit	8
Parity	even/odd/none
Stop bit	1/2 (no parity)
Network	RS485
Maximum cable length	1000 m (3280 ft)

# MODBUS® interface

FG-RC-MBS1Z1 / FG-AC-MBS1Z1 / FG-IR-BMG1Z1



FG-RC-MBS1Z1  
(3-wire RC-line type)



FG-AC-MBS1Z1  
(CN connector type)



FG-IR-BMG1Z1  
(IR type)

Up to  
1 indoor unit

MODBUS® interface enables air conditioners to be fully integrated into a MODBUS® network.

- Small, compact, and easy to install on DIN rails.
- No separate external power supply required.
- MODBUS® interface enables central monitoring and control of air conditioners from BMS.

## Installation example

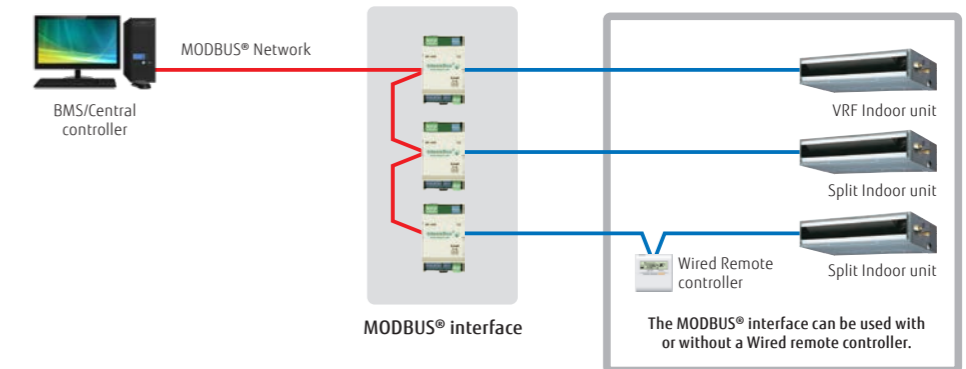

## [IR type] Connection to wall-mounted type

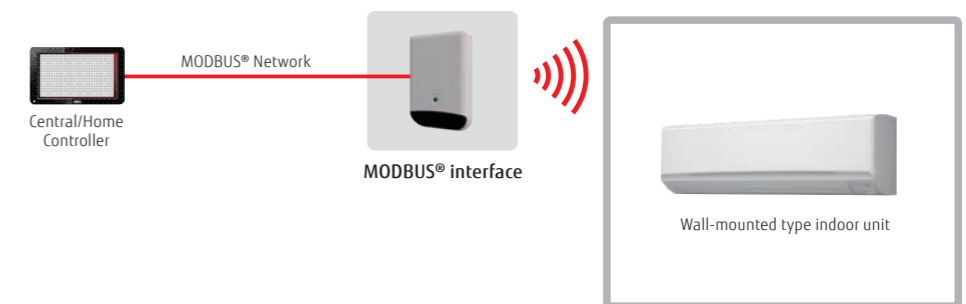

### Specifications

Model name	FG-RC-MBS1Z1 (3-wire RC-line type)	FG-AC-MBS1Z1 (CN connector type)	FG-IR-BMG1Z1 (IR type)
Number of controllable groups	1	1	1
Dimensions (H × W × D) (mm)	93 × 53 × 58	93 × 53 × 58	93 × 60 × 21
Weight (g)	85	85	55

# MODBUS® convertor for VRF

UTY-VMGX / FG-TL-MBS16Z1

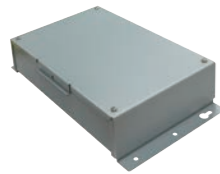

UTY-VMGX

Up to  
**9** units per VRF system  
Up to  
**100** outdoor units  
Up to  
**128** indoor units

MODBUS® convertor enables air conditioners to be fully integrated into a MODBUS® network.

- Compact and lightweight design
- Direct connection to MODBUS® network
- MODBUS® convertor enables central monitoring and control of air conditioners from BMS or a central controller.
- Up to 9 converters can be connected to a VRF network (UTY-VMGX). Simultaneous control, such as Power ON/ OFF and temperature setting, can be performed for each zone.
- If a connection error occurs after installation work is completed, the source of the error can be located easily.

## Installation example



FG-TL-MBS16Z1

Up to  
**16** indoor units  
Up to  
**16** outdoor units  
Up to  
**128** indoor units

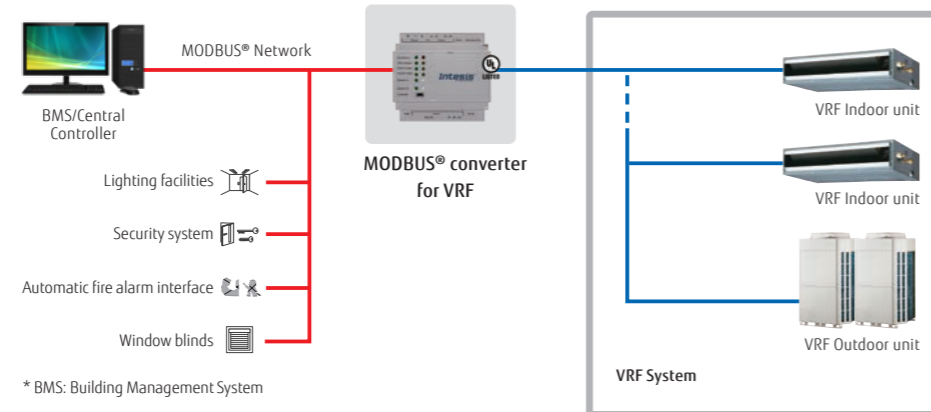
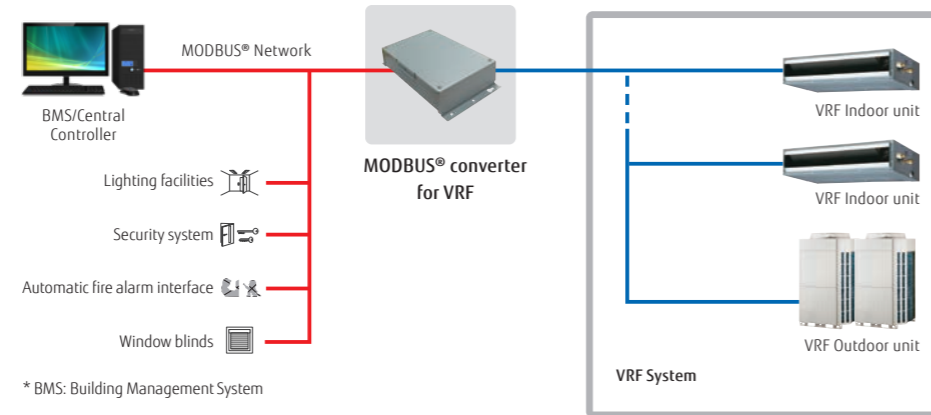

### Specifications

Model name	UTY-VMGX	FG-TL-MBS16Z1
Power supply	Single phase ~220 to 240 V 50/60 Hz	9 to 36 V DC, Max.: 140 mA or 24 V AC 50/60 Hz, Max.: 127 mA.*
Input power (W)	Max. 2	1.7
Dimensions (H × W × D) (mm)	54 × 260 × 150	90 × 88 × 56
Weight (g)	1,100	330

\*24 V DC power supply is recommended.

# BACnet® interface

FG-AC-BAC1Z1 / FG-IR-BMG1Z1



FG-AC-BAC1Z1 (CN connector type)



FG-IR-BMG1Z1 (IR type)

Up to  
**1** indoor units

- BACnet® interface connects BMS and a Fujitsu General split/multi-split/VRF system.
- Compatible with BACnet® (ANSI/ASHRAE-135-2012) application-specific controller (B-ASC)
- Compatible with BACnet®/IP over Ethernet.

## Installation example

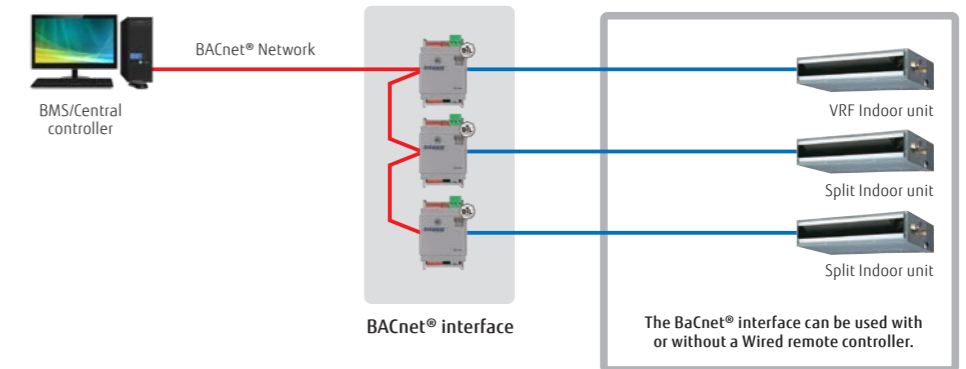

### [IR type] Connection to wall-mounted type

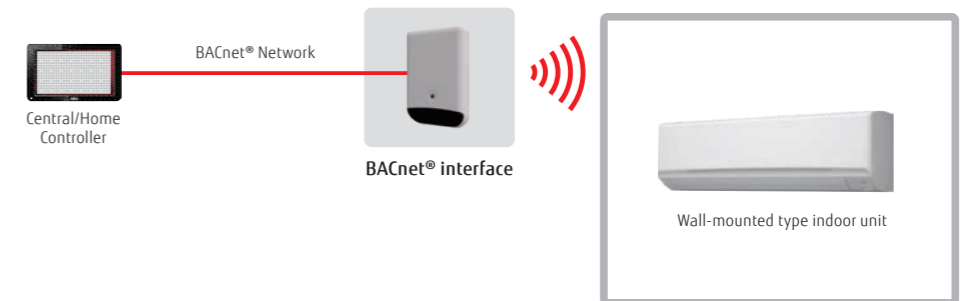

### Specifications

Model name	FG-AC-BAC1Z1 (CN connector type)	FG-IR-BMG1Z1 (IR type)
Number of controllable groups	1	1
Dimensions (H × W × D) (mm)	93 × 53 × 58	93 × 60 × 21
Weight (g)	85	55

12 V DC supplied by an indoor unit

# BACnet® gateway

UTY-ABGXZ1 (Software)



White-USB-key  
(Software Protection Key)



BACnet® is a registered trademark of ASHRAE. ASHRAE does not endorse, approve or test products for compliance with ASHRAE standards. Compliance of listed products to the requirements of ASHRAE Standard 135 is the responsibility of BACnet International (BI). BTL is a registered trademark of BACnet International.

Up to  
**4** VRF network systems  
Up to  
**400** outdoor units  
Up to  
**1,600** indoor units

## Installation example

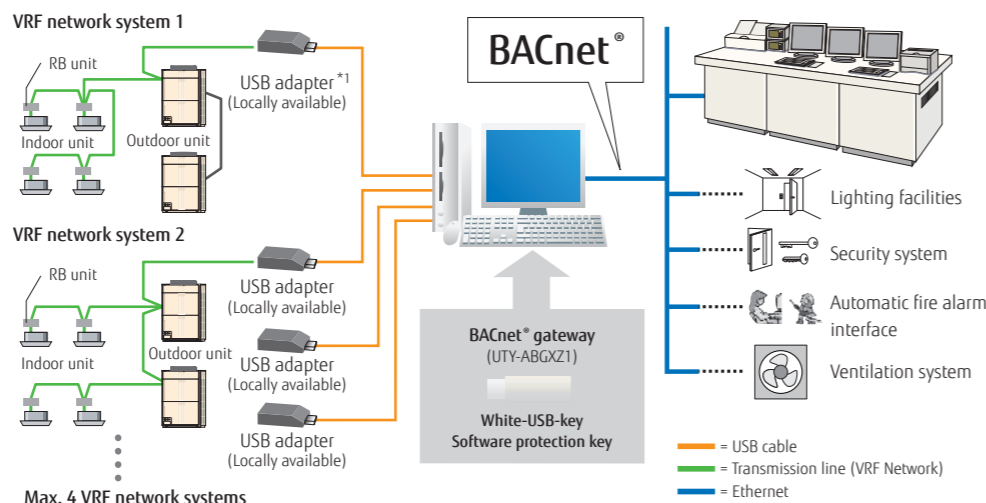

\*1: U10 USB network interface available from Echelon® Corporation.

## Computer requirements

	UTY-ABGXZ1
Operating system	<ul style="list-style-type: none"> <li>Microsoft® Windows® 7 Home Premium (32-bit or 64-bit) SP1, Windows® 7 Professional (32-bit or 64-bit) SP1</li> <li>Microsoft® Windows® 8.1 (32-bit or 64-bit), Windows® 8.1 Pro (32-bit or 64-bit)</li> <li>Microsoft® Windows® 10 Home (32-bit or 64-bit), Windows® 10 Pro (32-bit or 64-bit)</li> </ul> Supported languages: Chinese, English, French, German, Polish, Russian, and Spanish
CPU	Intel® Core™ i3 2 GHz or higher
Memory	<ul style="list-style-type: none"> <li>2 GB or more (for Windows® 7 [32-bit])</li> <li>4 GB or more (for Windows® 7 [64-bit], Windows® 8.1, and Windows® 10)</li> </ul>
HDD	40 GB or more of free space
Displayed items	1024 × 768 or higher resolution
Interfaces	<ul style="list-style-type: none"> <li>Ethernet port (for getting access to the internet using LAN)</li> <li>Up to 5 USB ports</li> <li>- 1 USB port required to connect to a White-USB-key/WibuKey</li> <li>- Up to 4 USB ports required to connect to an Echelon® U10 USB network interface</li> </ul> *The maximum number of required USB ports varies depending on the applicable system configuration.
Software	Adobe® Acrobat Reader® 9.0 or later

\*Echelon® U10 USB Network interface – TP/FT-10 Channel (Model name: 75010R) (Required for each VRF Network)

## Packing list

Name and shape	Quantity	Application
White-USB-key	1	Includes the software, user's manual, and license for BACnet® gateway.

# BACnet® gateway

UTY-VBGX (Hardware)



BACnet® is a registered trademark of ASHRAE. ASHRAE does not endorse, approve or test products for compliance with ASHRAE standards. Compliance of listed products to the requirements of ASHRAE Standard 135 is the responsibility of BACnet International (BI). BTL is a registered trademark of BACnet International.

Up to  
**1** VRF network systems  
Up to  
**32** refrigerant systems  
Up to  
**128** indoor units

## Installation example

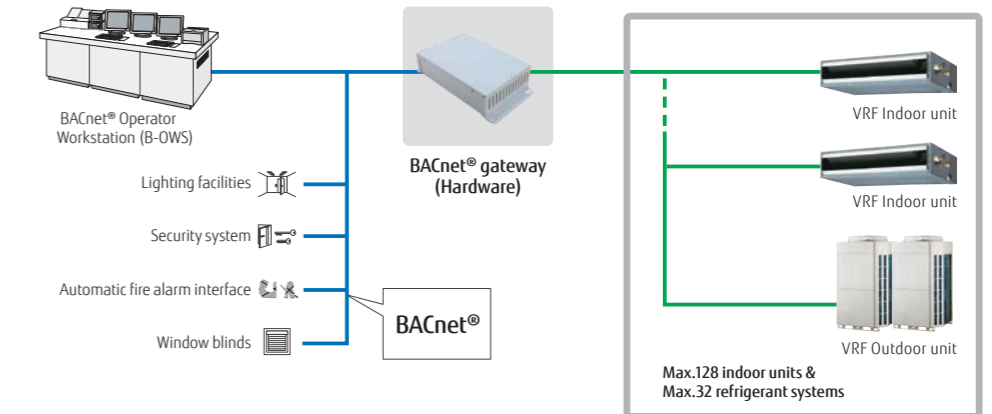

Max.128 indoor units &  
Max.32 refrigerant systems

## Specifications

Model name	UTY-VBGX
Number of controllable indoor units	128
Number of controllable refrigerant systems	32
Number of controllable VRF networks	1
Number of connectable units / one VRF network	4
Power supply	Single phase, 100-240 V, 50/60 Hz
Power consumption (W)	4.6 (max.)
Dimensions (H × W × D) (mm)	59.6 × 270.4 × 176
Weight (g)	1200

# BACnet®/MODBUS® router

FG-RTR-BAC32Z1 / FG-RTR-MBS32Z1



FG-RTR-BAC32Z1 (BAC net)



FG-RTR-MBS32Z1 (MODBUS®)

## Routing between BaCnet® MS/TP and BaCnet® IP networks

- Routing between BaCnet® MS/TP and BaCnet® IP networks
- Routing between MODBUS® RTU and MODBUS® TCP networks

## Installation example

[BaCnet® type]

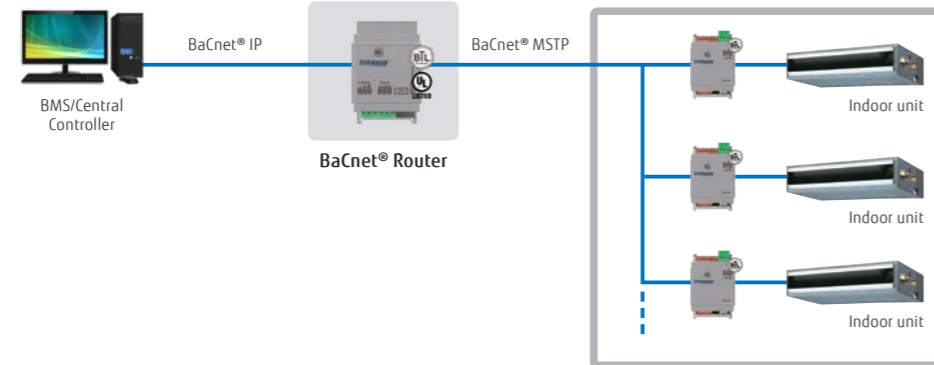

[MODBUS® type]

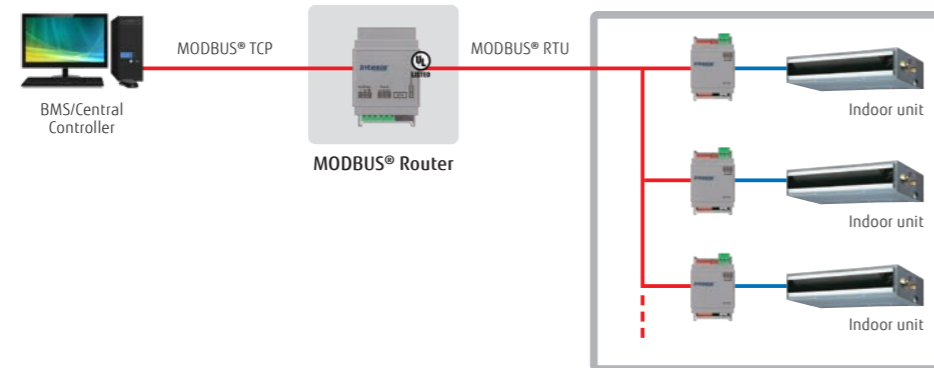

### Specifications

Model name	FG-RTR-BAC32Z1 (MS/TP to IP)	FG-RTR-MBS32Z1 (RTU to TCP)
Number of routable devices (max.)	32	32
Power supply	9 to 36 V DC, Max.: 140 mA or 24 V AC 50/60 Hz, Max.: 127 mA	9 to 36 V DC, Max.: 140 mA or 24 V AC 50/60 Hz, Max.: 127 mA
Power consumption (W)	1.7	1.7
Dimensions (H × W × D) (mm)	93 × 53 × 58	93 × 53 × 58
Weight (g)	150	150

# BACnet®/MODBUS® cloud device

FG-CLD-BMG4Z1 / FG-CLD-BMG8Z1 / FG-CLD-BMG16Z1 / FG-CLD-BMG32Z1



FG-CLD-BMG4Z1

- The most powerful configuration tool common to all BACnet® gateways provides the system integrators with the power to configure and monitor their systems in an easy and reliable manner.
- A simple, easy-to-use description for the ST Cloud Web and App User Interface, with all widgets customizable to the user's needs, enabling system integrators to easily offer the best user experience to customers who are in control of their BaCnet® or MODBUS® devices.

## Installation example

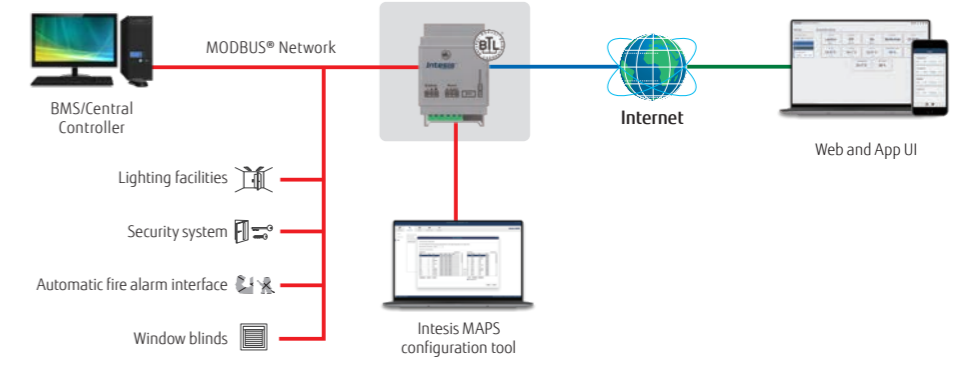

\*BMS: Building Management System

## Gateway features

- BaCnet® IP/MSTP or MODBUS® TCP/RTU connectivity
- Up to 32 devices can be connected to each gateway.
- Up to 12 widgets per device
- Easy device configuration with Intesis MAPS

## Next-generation services

- Industrial-grade connectivity now for building automation
- Fast and scalable real-time edge connectivity over HMS HubTM
- Full data control and protection
- Secure and remote updates during the application lifetime

## System Features

- Monitor and control all devices in an intuitive way
- Comes with a native iOS and Android app and a web interface
- Create scenes and interact with multiple concurrent devices
- Calendar that shows the daily planned installation commands
- Notifications keep you updated about system status
- Device sharing and usage permissions management
- Multiple site management from a common dashboard

### Specifications

Model name	FG-CLD-BMG4Z1	FG-CLD-BMG8Z1	FG-CLD-BMG16Z1	FG-CLD-BMG32Z1
Number of connectable BaCnet® (IP/MSTP) or MODBUS® (TCP/RTU) devices	4	8	16	32
Power supply	9 to 24 V DC, 50/60Hz	9 to 24 V DC, 50/60Hz	9 to 24 V DC, 50/60Hz	9 to 24 V DC, 50/60Hz
Power consumption (W)	1.7	1.7	1.7	1.7
Dimensions (H × W × D) (mm)	93 × 53 × 58	93 × 53 × 58	93 × 53 × 58	93 × 53 × 58
Weight (g)	150	150	150	150

## KNX® converter for indoor unit

UTY-VKSX



Up to  
**1** indoor unit

KNX® Converter enables individual control of an indoor unit.

- The new KNX® converter connects a central or home controller and a Fujitsu General indoor unit.
- Compact and lightweight design

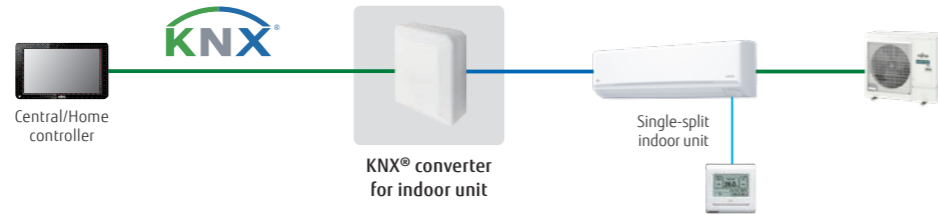

## KNX® converter for VRF

UTY-VKGX / FG-TL-KNX16Z1

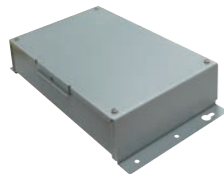

UTY-VKGX

Up to  
**100** outdoor units  
Up to  
**128** indoor units



FG-TL-KNX16Z1

Up to  
**16** indoor units  
Up to  
**16** outdoor units

KNX® converter enables centralized control of a system.

- KNX® converter connects a central or home controller and a Fujitsu General VRF system.
- Up to 128 indoor units and 100 outdoor units can be connected to a single KNX® converter. (UTY-VKGX)

Installation example

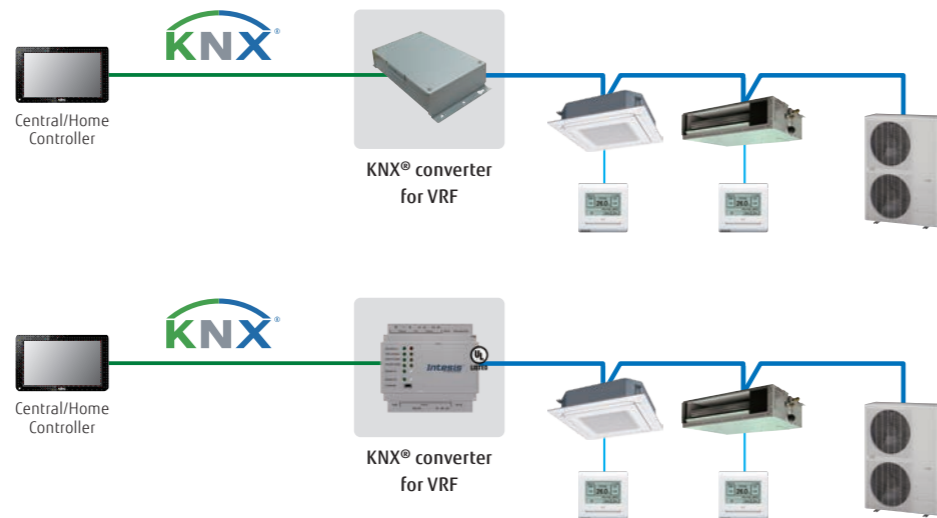

### Specifications

Model name	UTY-VKSX	UTY-VKGX	FG-TL-KNX16Z1
Power supply	12 V DC	Single phase ~220 to 240 V 50/60 Hz	9 to 36 V DC, Max.: 140 mA or 24 V AC 50/60 Hz, Max.: 127 mA.*
Input power (W)	0.6	1.5	1.6
Dimensions (H × W × D) (mm)	140 × 117 × 43	54 × 260 × 150	90 × 88 × 56
Weight (g)	215	1,200	340

\*24 V DC power supply is recommended.

## KNX® interface

FG-RC-KNX1Z1 / FG-AC-KNX1Z1 / FG-IR-KNX1Z1



### Intesis®



FG-RC-KNX1Z1  
(3-wire RC-line type)

### Intesis®



FG-AC-KNX1Z1  
(CN connector type)

### Intesis®



FG-IR-KNX1Z1  
(IR type)

Up to  
**1** indoor unit

The KNX® interface enables air conditioners to be fully integrated into a KNX® network system.

- Simple installation due to small and compact size.
- No separate external power supply required (only KNX® bus power required)

Installation example

[3-wire RC-line type/CN connector type]

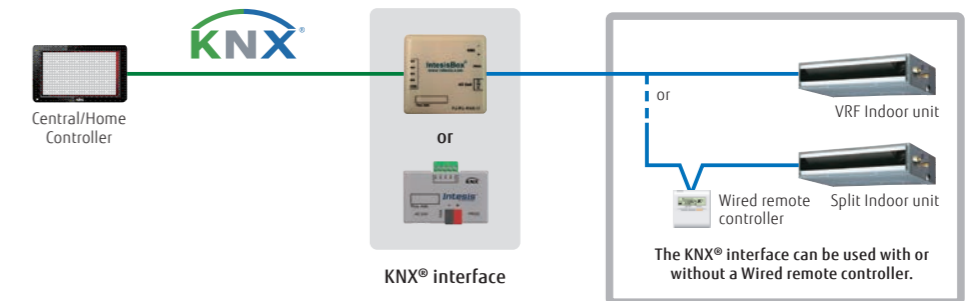

[IR type] Connection to wall-mounted type

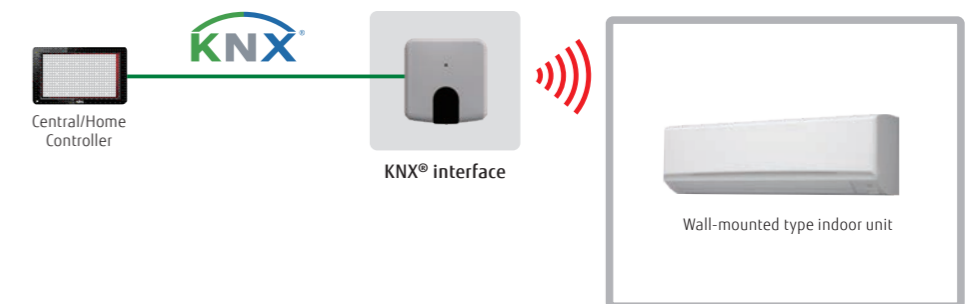

[IR type] Connection to a product other than wall-mounted type

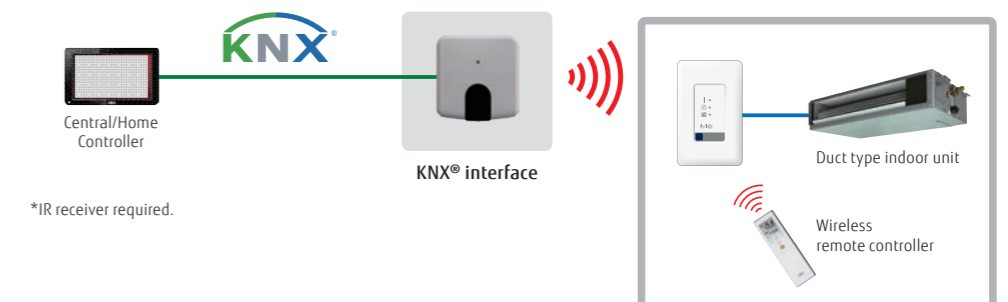

### Specifications

Model name	FG-RC-KNX1Z1 (3-wire RC-line type)	FG-AC-KNX1Z1 (CN connector type)	FG-IR-KNX1Z1 (IR type)
Number of controllable groups	1	1	1
Dimensions (H × W × D) (mm)	70 × 70 × 28	45 × 59 × 21	81 × 78 × 28
Weight (g)	70	35	76

## Network converter for single-split type

UTY-VTGX / UTY-VTGXV



UTY-VTGX  
DC power supply type



UTY-VTGXV  
AC power supply type

Up to  
**16** single indoor units  
Up to  
**1** group  
Up to  
**100** Network Converters

- A network converter is required when connecting a single-split system to a VRF network system.
- Compact and lightweight design
- Connectable to both nonpolar 2-core and polar 3-core remote controllers

### Installation example

- A 1-remote-controller type and a 2-remote-controller type are available.
- Power supply (220 to 240 V AC, 50/60 Hz) is required for the 2-remote-controllers type.

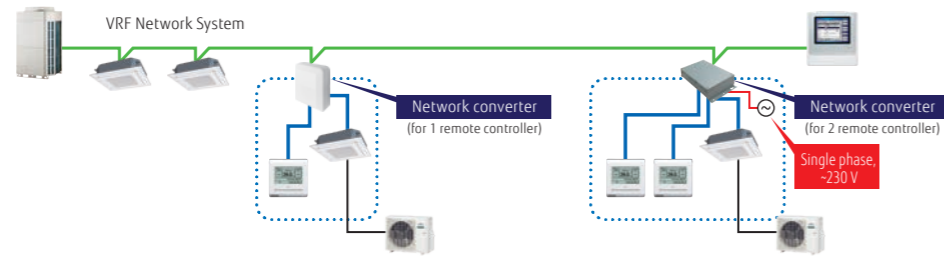

- Both nonpolar 2-core and polar 3-core type Wired remote controllers can be connected.

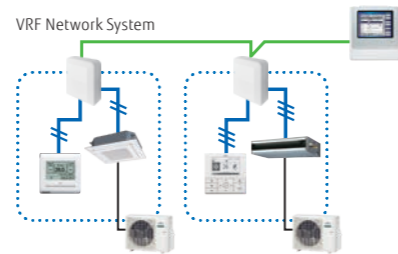

- Central control can be provided for single-split systems. (Up to 100 network converters can be connected in a VRF network system)

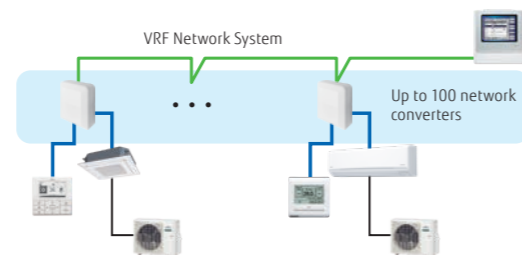

### Specifications

Model name	UTY-VTGX		UTY-VTGXV
	Polar 3-core 12 V DC	Nonpolar 2-core DC 12 V	Single phase ~220 to 240 V 50/60 Hz
Power supply			
Input power (W)	Max. 1.2 W		Max. 3
Dimensions (H × W × D) (mm)	140 × 117 × 43		54 × 260 × 150
Weight (g)	250		1,100

## Network converter for LONWORKS™

UTY-VLGX

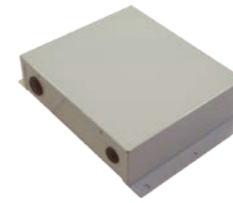

Up to  
**4** units to BMS  
Up to  
**100** outdoor units  
Up to  
**128** indoor units

- Connects the VRF network system to a LONWORKS™ open network to manage small and mid-sized BMS and VRF network system.
- The UTY-VLGX enables centralized monitoring and control of VRF network system from a BMS via a LONWORKS™ interface.
- Up to 128 Indoor units can be connected to one network converter for LONWORKS™

### Installation example

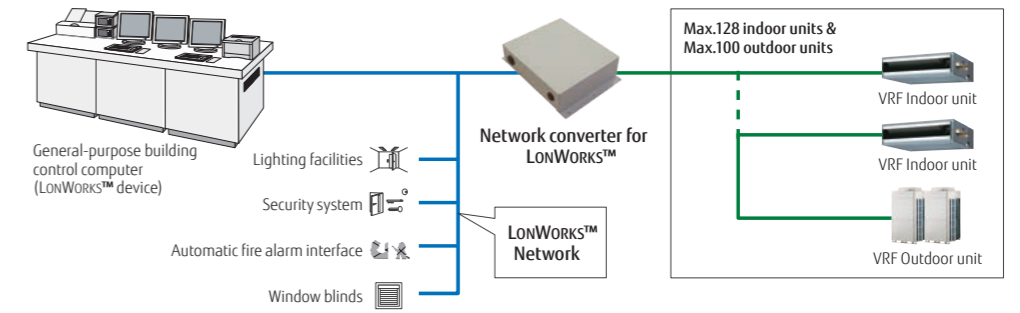

### Specifications

Model name	UTY-VLGX
Power supply	Single phase ~208 to 240 V 50/60 Hz
Power consumption (W)	4.5
Dimensions (H × W × D) (mm)	67 × 288 × 211
Weight (g)	1,500

### Transmission specifications (BMS side)

Transmission speed	78 kbps
Transceiver	FT-X1 (available from Echelon® Corporation)
Transmission line form	Free topology
Terminal resistor	None (converter to be attached at the terminal of a network)



# External switch controller

UTY-TERX



Up to  
**1** group

Air conditioner switching can be controlled by connecting this external switch controller to other sensor switches.

- In combination with a commercially available card-key switch or other sensors, this External switch controller enables the control of ON/OFF, room temperature, and fan speed of connected air conditioners as well as master control functions. This makes this product an ideal choice for use in hotel rooms.
- Card key or other sensor switches are locally available.
- The set temperature can be specified at two points each for cooling and heating operations (4 points in total).

## Installation example

Human sensor monitors the movement of a person in a room. When it detects that the person has left the room, it switches the air conditioner to low-capacity mode. When a person returns to the room, the air conditioner returns to the previous operation mode.

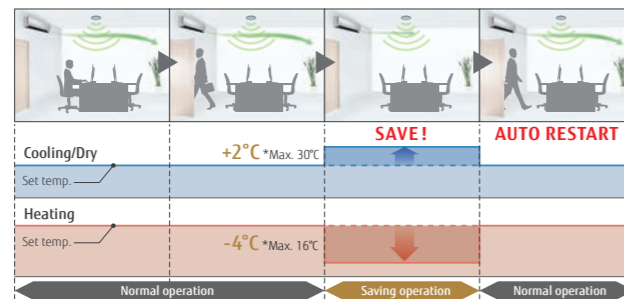

Human sensor equipment needs to be purchased separately.  
Human sensor is not mounted on an External switch controller.

# Signal amplifier

UTY-VSGXZ1

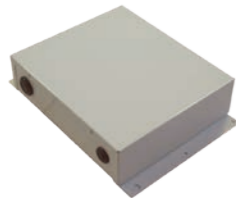

- The transmission line can be extended up to 3,600 m using multiple Signal amplifiers.
- Up to 8 Signal amplifiers can be added in a VRF network system.
- A Signal amplifier is required.
  - (1) When the total wiring length of the transmission line exceeds 500 m.
  - (2) When the total number of units on the transmission line exceeds 64.

## Installation example

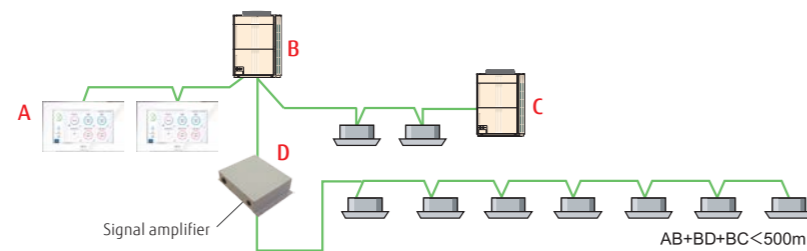

## Specifications

Model name	UTY-VSGXZ1	UTY-TERX
Power supply	Single phase ~208 to 240 V 50/60 Hz	6.5 to 16 V DC
Power consumption (W)	4.5	-
Dimensions (H × W × D) (mm)	67 × 288 × 211	140 × 117 × 43
Weight (g)	1,500	250

12 V DC supplied by an indoor unit



# Controller system list (available) for Split/Multi-split

Controller Options/Accessories:



Type	Refrigerant	Indoor unit																							Outdoor unit		
		Wall-mounted									Cassette		Duct										Multi-split				Single phase
		Designer Range			Standard Range			ECO Range			Compact 4-way flow Range	Circular flow Range	Slim	Medium static pressure (High efficiency & EcoStar)	Medium static pressure (Compact)	Medium static pressure (Standard)	High static pressure	BIG	Floor	Ceiling	Wall-mounted	Compact cassette	Mini duct	Slim duct	5/6-unit multi-split		
	ASEH07/09/12/14KGTG, ASYG07/09/12/14KGTG, ASYG07/09/12/14KGTG	ASEG 07/09/12/14 KET, KET-B, ASYG 07/09/12/14 KET, KET-B	ASEH07/09/12/14KMG, KMG-B, ASYG07/09/12/14KMG, ASYG07/09/12/14KMG	ASEG 18/24KMT	ASEH 30/36KMTB	ASEH 07/09/12 KNCA	ASEG 07/09/12 KPCE	ASEH 07/09/12 KLTA	AUXG 09/12/14/18/22/24 KVLA	AUXG 18/22/24/30/36/45/54 KRLB	ARXG 09/12/14/18 KLLAP	ARXH 12/14/18/22/24/30/36/45/54 KMTP	ARXG 12/14/18/22/24/30/36/45/54 KHTAP	ARXG 24/30/36/45 KMLA	ARXG 45/54KHTB	ARYG 60LHTA	ARYG 72/90LHTA	AGEG 09/12/14 KVCA	ABEG 18/22/24/30/36/45/54 KRTA	ASEH 05KNCA	ASEG 22KMT	AUXG 07KVA	ARXG 07/09/12/14/18 KSLAP	ARXG 07KLLAP	AOEG 36KBTA5		
																									AOYG 45LBLA6		
Controllers		● UTY-RVRY+ UTY-TWRXZ2									● UTY-RVRY	● UTY-RVRY						● UTY-RVRY	● UTY-RVRY+ UTY-TWRXZ3	● UTY-RVRY	● UTY-RVRY+ UTY-TWRXZ2				● UTY-RVRY		
		● UTY-RNRYZ5+ UTY-TWRXZ2									● UTY-RNRYZ5	● UTY-RNRYZ5						● UTY-RNRYZ5	● UTY-RNRYZ5+ UTY-TWRXZ3	● UTY-RNRYZ5	● UTY-RNRYZ5+ UTY-TWRXZ2				● UTY-RNRYZ5		
		● UTY-RLRY+ UTY-TWRXZ2									● UTY-RLRY	● UTY-RLRY						● UTY-RLRY	● UTY-RLRY+ UTY-TWRXZ3	● UTY-RLRY	● UTY-RLRY+ UTY-TWRXZ2				● UTY-RLRY		
		● UTY-RCRYZ1+ UTY-TWRXZ2									● UTY-RCRYZ1	● UTY-RCRYZ1						● UTY-RCRYZ1	● UTY-RCRYZ1+ UTY-TWRXZ3	● UTY-RCRYZ1	● UTY-RCRYZ1+ UTY-TWRXZ2				● UTY-RCRYZ1		
										● UTY-RVNYM		● UTY-RVNYM		● UTY-RVNYM		● UTY-RVNYM		● UTY-RVNYM								● UTY-RVNYM	
										● UTY-RNNYM		● UTY-RNNYM		● UTY-RNNYM		● UTY-RNNYM		● UTY-RNNYM								● UTY-RNNYM	
Simple remote controller	 Nonpolar 2-core type	● UTY-RSRY UTY-RHRY+ UTY-TWRXZ2									● UTY-RSRY UTY-RHRY	● UTY-RSRY UTY-RHRY						● UTY-RSRY UTY-RHRY	● UTY-RSRY UTY-RHRY+ UTY-TWRXZ3	● UTY-RSRY UTY-RHRY	● UTY-RSRY UTY-RHRY+ UTY-TWRXZ2				● UTY-RSRY UTY-RHRY		
Home central remote controller																									● UTY-DMMYM1*3 (KBTA5) ● UTY-DMMYM*3 (LBLA6)		
Wireless remote controller									● UTY-LNTY															● UTY-LNTY			
IR receiver unit with Wireless remote controller	 For Duct type																										
	 For Duct type For Cassette type For Ceiling type									● UTY-LBTYC				● UTY-LBTYM			● UTY-LBTYM			● UTY-LBTYH					● UTY-LBTYM		

\*1: Available only when the WLAN adapter (UY-TFSXF2) is removed. \*2 Available only when the WLAN adapter (UY-TFSXZ1) is removed. \*3 Consult your dealer for conditions of use.

# Controller system list (available) for Split/Multi-split

Controller Options/Accessories:



Type	Refrigerant	Indoor unit																										
		Wall-mounted									Cassette		Duct						Floor		Ceiling		Multi-split					
		Designer Range			Standard Range			ECO Range			Compact 4-way flow Range	Circular flow Range	Slim	Medium static pressure (High Efficiency & Ambient)	Medium static pressure (Compact)	Medium static pressure (Standard)	High static pressure	BIG	Floor	Ceiling	Wall-mounted	Compact cassette	Mini duct	Slim duct				
ASEH07/09/12/14KGTG, ASYG07/09/12/14KGTG, ASYG07/09/12/14KGTG	ASEG 07/09/12/14 KET, KET-B	ASEG 07/09/12/14 KETE, KETE-B	ASEH07/09/12/14KMG, KMCG-B, ASYG07/09/12/14KMG, ASYG07/09/12/14KMG	ASEG 18/24KMT	ASEH 30/36KMTB	ASEH 07/09/12 KNCA	ASEG 07/09/12 KPCE	ASEH 07/09/12 KLTA	ASEG 18/24KLCA	AUXG 09/12/14/18/22/24 KVLA	AUXG 18/22/24/30/36/45/54 KRLB	ARXG 09/12/14/18 KLLAP	ARXH 12/14/18/22/24/30/36/45/54 KMTAP	ARXG 12/14/18/22/24/30/36/45/54 KHTAP	ARXG 24/30/36/45 KMLA	ARXG 45/54KHTB		ARYG 60LHTA	ARYG 72/90LHTA	AGEG 09/12/14 KVCA	ABEG 18/22/24/30/36/45/54 KRTA	ASEH 05KNCA	ASEG 22KMT	AUXG 07KVLA	ARXG 07/09/12/14/18 KSLAP	ARXG 07KLLAP		
Interfaces	MODBUS® Converter	● UTY-VMSX									● UTY-VMSX		● UTY-VMSX						● UTY-VMSX		● UTY-VMSX		● UTY-VMSX					
	MODBUS® interface	● FG-AC-MBS1Z1									● FG-RC-MBS1Z1 ● FG-AC-MBS1Z1		● FG-RC-MBS1Z1 ● FG-AC-MBS1Z1						● FG-AC-MBS1Z1		● FG-RC-MBS1Z1 ● FG-AC-MBS1Z1		● FG-AC-MBS1Z1		● FG-RC-MBS1Z1 ● FG-AC-MBS1Z1			
KNX®	converter	● UTY-VKSX									● UTY-VKSX		● UTY-VKSX						● UTY-VKSX		● UTY-VKSX		● UTY-VKSX					
	KNX® interface	● FG-AC-KNX1Z1									● FG-RC-KNX1Z1 ● FG-AC-KNX1Z1		● FG-RC-KNX1Z1 ● FG-AC-KNX1Z1						● FG-AC-KNX1Z1		● FG-RC-KNX1Z1 ● FG-AC-KNX1Z1		● FG-AC-KNX1Z1		● FG-RC-KNX1Z1 ● FG-AC-KNX1Z1			
WLAN adapter	3-wire RC-line type <sup>1</sup> CN connector type	● UTY-TFSX13 ● UTY-TFSXZ1									● UTY-TFSX13 ● UTY-TFSXZ1		● UTY-TFSX13 ● UTY-TFSXZ1						● UTY-TFNXZ1		● UTY-TFSX13 ● UTY-TFSXZ1		● UTY-TFSX13 ● UTY-TFSXZ1					
	USB type <sup>1</sup>	● Accessory (KGTG, KGT, KET, KET-B, KMCG, KMCF) ● UTY-TFSXH3, UTY-TFSXF2 (KGT, KETE, KETE-B, KMCE)									● UTY-TFSXH3 ● UTY-TFSXF2		● Accessory						● UTY-TFSXH3 ● UTY-TFSXF2		● Accessory		● UTY-TFSXH3 ● UTY-TFSXF2					
External switch controller	3-wire RC-line type CN connector type	● FG-AC-WIF1Z1									● FG-RC-WIF1Z2 ● FG-AC-WIF1Z1		● FG-RC-WIF1Z2 ● FG-AC-WIF1Z1						● FG-AC-WIF1Z1		● FG-RC-WIF1Z2 ● FG-AC-WIF1Z1		● FG-AC-WIF1Z1		● FG-RC-WIF1Z2 ● FG-AC-WIF1Z1			
	IR type	● FG-IR-WIF1Z1									● FG-IR-WIF1Z1+ ● UTY-LBTYC		● FG-IR-WIF1Z1+ ● UTY-LBTYM						● FG-IR-WIF1Z1+ ● UTY-LRHYM		● FG-IR-WIF1Z1 ● FG-IR-WIF1Z1+ ● UTY-LBTYH		● FG-IR-WIF1Z1		● FG-IR-WIF1Z1+ ● UTY-LBTYM			
Network converter for single-split type	3-wire RC-line type CN connector type	● FG-AC-WMP1Z1									● FG-RC-WMP1Z1 ● FG-AC-WMP1Z1		● FG-RC-WMP1Z1 ● FG-AC-WMP1Z1						● FG-AC-WMP1Z1		● FG-RC-WMP1Z1 ● FG-AC-WMP1Z1		● FG-AC-WMP1Z1		● FG-RC-WMP1Z1 ● FG-AC-WMP1Z1			
	IR type	● FG-IR-WMP1Z1									● FG-IR-WMP1Z1+ ● UTY-LBTYC		● FG-IR-WMP1Z1+ ● UTY-LBTYM						● FG-IR-WMP1Z1+ ● UTY-LRHYM		● FG-IR-WMP1Z1 ● FG-IR-WMP1Z1+ ● UTY-LBTYH		● FG-IR-WMP1Z1		● FG-IR-WMP1Z1+ ● UTY-LBTYM			
Network converter for single-split type	DC power supply type	● UTY-TERX+UTY-TWRXZ2									● UTY-TERX		● UTY-TERX						● UTY-TERX+ ● UTY-TWRXZ3		● UTY-TERX		● UTY-TERX+ ● UTY-TWRXZ2					
	AC power supply type	● UTY-VTGX+UTY-TWRXZ2 ● UTY-VTGXV+UTY-TWRXZ2									● UTY-VTGX ● UTY-VTGXV		● UTY-VTGX ● UTY-VTGXV						● UTY-VTGX+ ● UTY-TWRXZ3 ● UTY-VTGXV+ ● UTY-TWRXZ3		● UTY-VTGX ● UTY-VTGXV		● UTY-VTGX+ ● UTY-TWRXZ2 ● UTY-VTGXV+ ● UTY-TWRXZ2					

\*1: Available only when the WLAN adapter (UY-TFSXF2) is removed. \*2: Available only when the WLAN adapter (UTY-TFSXZ1) is removed.  
\*3: For compatibility of the new WLAN adapters with the indoor units which are not listed in this catalogue, please refer to page C-021.

# Controller system list (available) for VRF

Controller Options:



Type	Refrigerant	Indoor unit														Indoor unit																																	
		Cassette		Duct				Duct			Floor		Ceiling/Floor		Ceiling		Wall-mounted																																
		One-way flow	3D flow	Compact		Slim type	Large type	Low static pressure duct			Low static pressure duct	Medium static pressure	High static pressure	-	External EEV	Ceiling/Floor	Ceiling	-	External EEV	-	External EEV	-	-																										
				Grid type/Standard type	High Efficiency			Mini (With drain pump)	Slim (With drain pump)	High Efficiency														High Efficiency	Normal	Normal																							
		AUXB 004/005/007/009/012/014/018HLAH		AUXN 009/012/014HLAH				ARXD 004/005/007/009/012/014/018/024HLAH		ARXP 009/012/014HLAH						ASVA 004/005/007/009/012/014HCAH		ASVE 004/005/007/009/012/014HCAH																															
		AUXV 004/007/009/012/014/018/024GLEH		AUXS 018/024GLEH		AUXB 004/007/009/012/014/018/024GLEH		AUXM 018/024/030GLEH		AUXK 018/024/030/034/036/045/054GLEH		ARXK 004/007/009/012/014/018/024GLGH		ARXD 04GALH		ARXD 007/009/012/014/018/024GLEH		ARXP 018/030GLFH		ARXA 024/030/036/045GLEH		ARXC 036/045/060/072/090/096GTEH		ACYA 004/007/009/012/014GCGH		ACYE 004/007/009/012/014GCEH		ABYA 012/014/018/024GTEH		ABYA 030/036/045/054GTEH		ASVA 004/007/009GCGH		ASVE 004/007/009GCEH		ASVA 012/014GCGH		ASVE 012/014GCEH		ASVA 18/24GBCH		ASVA 030/034GTEH							
Wired remote controller																								●	UTY-RVRY																							●	UTY-RVRY
																								●	UTY-RNRYZ5																							●	UTY-RNRYZ5
																								●	UTY-RLRY																							●	UTY-RLRY
																								●	UTY-RCRYZ1																							●	UTY-RCRYZ1
Simple remote controller	 Nonpolar 2-core type																							●	UTY-RSRY UTY-RHRY																							●	UTY-RSRY UTY-RHRY
Wireless remote controller	 UTY-LNVY UTY-LNHY																							●	UTY-LNVY UTY-LNHY																							●	UTY-LNVY UTY-LNHY
IR receiver unit		●	UTY-TRHX			●	UTY-LBHXD	●	UTY-TRHX	●	UTB-YWC	●	UTY-TRHX				●	UTY-TRHX																															
Central remote controller																								●	UTY-DCGYZ3																							●	UTY-DCGYZ3
Touch panel controller																								●	UTY-DTGYZ1																							●	UTY-DTGYZ1
System controller, System controller Lite																								●	UTY-APGXZ1, UTY-ALGXZ1																							●	UTY-APGXZ1, UTY-ALGXZ1

# Controller system list (available) for VRF

Controller Options:



Type	Refrigerant	Indoor unit												Indoor unit												
		Cassette		Slim type		Large type		Duct				Duct		Floor		Ceiling/Floor		Ceiling		Wall-mounted						
		One-way flow	3D flow	Compact Grid type/Standard type		Circular flow		Mini (With drain pump)	Low static pressure duct			Low static pressure duct	Medium static pressure	High static pressure	-	external EEV	-	external EEV	-	external EEV	-	-				
				High Efficiency				Slim (With drain pump)	High Efficiency		High Efficiency	Normal	Normal													
		AUXB 004/005/007/009/012/014/018/024HLAH	AUXN 009/012/014 HLAH				ARXD 004/005/007/009/012/014/018/024 HLAH	ARXP 009/012/014 HLAH												ASXA 004/005/007/009/012/014 HCAH	ASXE 004/005/007/009/012/014 HCAH					
		AUXV 004/007/009/012/014/018/024GLEH	AUXS 018/024 GLEH	AUXB 004/007/009/012/014/018/024GLEH		AUXM 018/024/030 GLEH	AUXK 018/024/030/034/036/045/054GLEH	ARXK 004/007/009/012/014/018/024GLGH	ARXD 04GALH	ARXD 007/009/012/014/018/024 GLEH		ARXP 018/030 GLFH	ARXA 024/030/036/045 GLEH	ARXC 036/045/060/072/090/096 GTEH	ACYA 004/007/009/012/014 GCGH	ACYE 004/007/009/012/014 GCEH	ABYA 012/014/018/024 GTEH	ABYA 030/036/045/054 GTEH	ASXA 004/007/009 GCGH	ASXE 004/007/009 GCEH	ASXA 012/014GCGH	ASXE 012/014GCEH	ASXA 18/24GBCH	ASXA 030/034GTEH		
Interfaces		UTY-ABGX1, UTY-VBGX																								
		UTY-ABGX1, UTY-VBGX																								
BACnet® gateway		FG-AC-BAC1Z1																								
		FG-IR-BMG1Z1+ UTY-TRHX	FG-IR-BMG1Z1	FG-IR-BMG1Z1+ UTY-LBHXD	FG-IR-BMG1Z1+ UTY-TRHX	FG-IR-BMG1Z1+ UTY-TRHX	FG-IR-BMG1Z1+ UTY-TRHX	FG-IR-BMG1Z1+ UTY-TRHX	FG-IR-BMG1Z1+ UTY-TRHX	FG-IR-BMG1Z1+ UTY-TRHX	FG-IR-BMG1Z1+ UTY-TRHX	FG-IR-BMG1Z1+ UTY-TRHX	FG-IR-BMG1Z1+ UTY-TRHX	FG-IR-BMG1Z1+ UTY-TRHX	FG-IR-BMG1Z1+ UTY-TRHX	FG-IR-BMG1Z1+ UTY-TRHX	FG-IR-BMG1Z1+ UTY-TRHX	FG-IR-BMG1Z1+ UTY-TRHX	FG-IR-BMG1Z1+ UTY-TRHX	FG-IR-BMG1Z1+ UTY-TRHX	FG-IR-BMG1Z1+ UTY-TRHX	FG-IR-BMG1Z1+ UTY-TRHX	FG-IR-BMG1Z1+ UTY-TRHX	FG-IR-BMG1Z1+ UTY-TRHX	FG-IR-BMG1Z1+ UTY-TRHX	FG-IR-BMG1Z1+ UTY-TRHX
Network converter for LonWorks™		UTY-VLGX																								
		UTY-VMSX																								
MODBUS® Converter		UTY-VMGX FG-TL-MBS16Z1																								
		FG-IR-BMG1Z1+ UTY-TRHX	FG-IR-BMG1Z1	FG-IR-BMG1Z1+ UTY-LBHXD	FG-IR-BMG1Z1+ UTY-TRHX	FG-IR-BMG1Z1+ UTY-TRHX	FG-IR-BMG1Z1+ UTY-TRHX	FG-IR-BMG1Z1+ UTY-TRHX	FG-IR-BMG1Z1+ UTY-TRHX	FG-IR-BMG1Z1+ UTY-TRHX	FG-IR-BMG1Z1+ UTY-TRHX	FG-IR-BMG1Z1+ UTY-TRHX	FG-IR-BMG1Z1+ UTY-TRHX	FG-IR-BMG1Z1+ UTY-TRHX	FG-IR-BMG1Z1+ UTY-TRHX	FG-IR-BMG1Z1+ UTY-TRHX	FG-IR-BMG1Z1+ UTY-TRHX	FG-IR-BMG1Z1+ UTY-TRHX	FG-IR-BMG1Z1+ UTY-TRHX	FG-IR-BMG1Z1+ UTY-TRHX	FG-IR-BMG1Z1+ UTY-TRHX	FG-IR-BMG1Z1+ UTY-TRHX	FG-IR-BMG1Z1+ UTY-TRHX	FG-IR-BMG1Z1+ UTY-TRHX	FG-IR-BMG1Z1+ UTY-TRHX	FG-IR-BMG1Z1+ UTY-TRHX
MODBUS® interface		FG-AC-MBS1Z1																								
		FG-RC-MBS1Z1																								
KNX® converter		FG-IR-BMG1Z1+ UTY-TRHX	FG-IR-BMG1Z1	FG-IR-BMG1Z1+ UTY-LBHXD	FG-IR-BMG1Z1+ UTY-TRHX	FG-IR-BMG1Z1+ UTY-TRHX	FG-IR-BMG1Z1+ UTY-TRHX	FG-IR-BMG1Z1+ UTY-TRHX	FG-IR-BMG1Z1+ UTY-TRHX	FG-IR-BMG1Z1+ UTY-TRHX	FG-IR-BMG1Z1+ UTY-TRHX	FG-IR-BMG1Z1+ UTY-TRHX	FG-IR-BMG1Z1+ UTY-TRHX	FG-IR-BMG1Z1+ UTY-TRHX	FG-IR-BMG1Z1+ UTY-TRHX	FG-IR-BMG1Z1+ UTY-TRHX	FG-IR-BMG1Z1+ UTY-TRHX	FG-IR-BMG1Z1+ UTY-TRHX	FG-IR-BMG1Z1+ UTY-TRHX	FG-IR-BMG1Z1+ UTY-TRHX	FG-IR-BMG1Z1+ UTY-TRHX	FG-IR-BMG1Z1+ UTY-TRHX	FG-IR-BMG1Z1+ UTY-TRHX	FG-IR-BMG1Z1+ UTY-TRHX	FG-IR-BMG1Z1+ UTY-TRHX	FG-IR-BMG1Z1+ UTY-TRHX
		UTY-VKX																								
KNX® interface		FG-AC-KNX1Z1																								
		FG-RC-KNX1Z1																								
WLAN adapter		FG-IR-KNX1Z1+ UTY-TRHX	FG-IR-KNX1Z1	FG-IR-KNX1Z1+ UTY-LBHXD	FG-IR-KNX1Z1+ UTY-TRHX	FG-IR-KNX1Z1+ UTY-TRHX	FG-IR-KNX1Z1+ UTY-TRHX	FG-IR-KNX1Z1+ UTY-TRHX	FG-IR-KNX1Z1+ UTY-TRHX	FG-IR-KNX1Z1+ UTY-TRHX	FG-IR-KNX1Z1+ UTY-TRHX	FG-IR-KNX1Z1+ UTY-TRHX	FG-IR-KNX1Z1+ UTY-TRHX	FG-IR-KNX1Z1+ UTY-TRHX	FG-IR-KNX1Z1+ UTY-TRHX	FG-IR-KNX1Z1+ UTY-TRHX	FG-IR-KNX1Z1+ UTY-TRHX	FG-IR-KNX1Z1+ UTY-TRHX	FG-IR-KNX1Z1+ UTY-TRHX	FG-IR-KNX1Z1+ UTY-TRHX	FG-IR-KNX1Z1+ UTY-TRHX	FG-IR-KNX1Z1+ UTY-TRHX	FG-IR-KNX1Z1+ UTY-TRHX	FG-IR-KNX1Z1+ UTY-TRHX	FG-IR-KNX1Z1+ UTY-TRHX	FG-IR-KNX1Z1+ UTY-TRHX
		UTY-TFSX3 UTY-TFSXZ1																								
WLAN adapter		FG-AC-WIF1Z1																								
		FG-RC-WIF1Z2																								
WLAN adapter		FG-IR-WIF1Z1+ UTY-TRHX	FG-IR-WIF1Z1	FG-IR-WIF1Z1+ UTY-LBHXD	FG-IR-WIF1Z1+ UTY-TRHX	FG-IR-WIF1Z1+ UTY-TRHX	FG-IR-WIF1Z1+ UTY-TRHX	FG-IR-WIF1Z1+ UTY-TRHX	FG-IR-WIF1Z1+ UTY-TRHX	FG-IR-WIF1Z1+ UTY-TRHX	FG-IR-WIF1Z1+ UTY-TRHX	FG-IR-WIF1Z1+ UTY-TRHX	FG-IR-WIF1Z1+ UTY-TRHX	FG-IR-WIF1Z1+ UTY-TRHX	FG-IR-WIF1Z1+ UTY-TRHX	FG-IR-WIF1Z1+ UTY-TRHX	FG-IR-WIF1Z1+ UTY-TRHX	FG-IR-WIF1Z1+ UTY-TRHX	FG-IR-WIF1Z1+ UTY-TRHX	FG-IR-WIF1Z1+ UTY-TRHX	FG-IR-WIF1Z1+ UTY-TRHX	FG-IR-WIF1Z1+ UTY-TRHX	FG-IR-WIF1Z1+ UTY-TRHX	FG-IR-WIF1Z1+ UTY-TRHX	FG-IR-WIF1Z1+ UTY-TRHX	FG-IR-WIF1Z1+ UTY-TRHX
		FG-AC-WMP1Z1																								
WLAN adapter		FG-IR-WMP1Z1+ UTY-TRHX	FG-IR-WMP1Z1	FG-IR-WMP1Z1+ UTY-LBHXD	FG-IR-WMP1Z1+ UTY-TRHX	FG-IR-WMP1Z1+ UTY-TRHX	FG-IR-WMP1Z1+ UTY-TRHX	FG-IR-WMP1Z1+ UTY-TRHX	FG-IR-WMP1Z1+ UTY-TRHX	FG-IR-WMP1Z1+ UTY-TRHX	FG-IR-WMP1Z1+ UTY-TRHX	FG-IR-WMP1Z1+ UTY-TRHX	FG-IR-WMP1Z1+ UTY-TRHX	FG-IR-WMP1Z1+ UTY-TRHX	FG-IR-WMP1Z1+ UTY-TRHX	FG-IR-WMP1Z1+ UTY-TRHX	FG-IR-WMP1Z1+ UTY-TRHX	FG-IR-WMP1Z1+ UTY-TRHX	FG-IR-WMP1Z1+ UTY-TRHX	FG-IR-WMP1Z1+ UTY-TRHX	FG-IR-WMP1Z1+ UTY-TRHX	FG-IR-WMP1Z1+ UTY-TRHX	FG-IR-WMP1Z1+ UTY-TRHX	FG-IR-WMP1Z1+ UTY-TRHX	FG-IR-WMP1Z1+ UTY-TRHX	FG-IR-WMP1Z1+ UTY-TRHX
		UTY-TERX																								
External switch controller		UTY-TERX																								

\*1: For compatibility of the new WLAN adapters with the indoor units which are not listed in this catalogue, please refer to page C-021.

# Optional parts Overview

For Split & Multi-split, VRF

A variety of optional parts are available to enable installation of the selected indoor unit properly according to the environment.

## Optional Parts For Cassette



**Human sensor kit**  
A built-in thermo sensor monitors and controls room temperature accurately.



**Cassette grille**  
A lineup of cassette grilles that match a variety of interiors. A grid ceiling-type cassette grille has been added to the lineup.



**Silver ion filter**  
The Silver ion filter helps to keep indoor air free from viruses, bacteria and molds.\*



**Fresh air intake kit**  
Fresh air can be taken in by a fan connected to an external control unit.

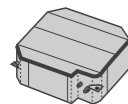

**Insulation kit for high humidity**  
Insulation kit for high humidity is used when the installation location is in a high humidity environment.

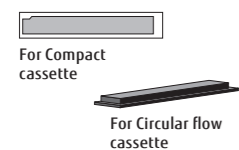

**Air outlet shutter plate**  
Airflow directions can be changed to 3 directions using the Air outlet shutter plate depending on the installation location.

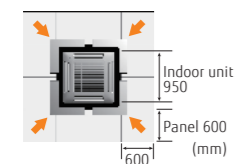

**Wide Panel**  
When a cassette type is installed in a narrow space in the ceiling, the wide panel fills in that space.

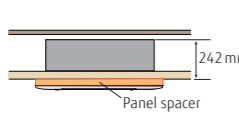

**Panel spacer**  
If the ceiling space is tight and the main body protrudes from the ceiling surface, a panel spacer can be used as a decorative trim.

## Optional Parts For V-IV



**Pressure sensor kit**  
When installed, the height difference between the outdoor unit and indoor unit can be allowed up to 110 m.

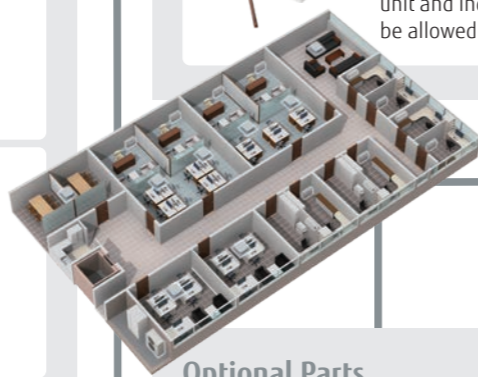

## Optional Parts For R32 VRF products



**Gas Sensor kit**  
Used to ensure standards compliance and safety when R32 VRF products are installed.



**Expansion kit**  
Connect to indoor units to expand the number of inputs and outputs when using multiple safety devices or external input/output functions.

## Optional Parts For Floor

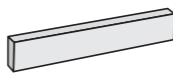

**Half concealed kit**  
Used to half conceal a floor type indoor unit in the wall.



**Silver ion filter**  
The Silver ion filter helps to keep indoor air free from viruses, bacteria and molds.\*

## Optional Parts For Duct & Ceiling



**Auto louver grille kit**  
The optional clean-looking flat Auto louver grille blends into any interior and provides a comfortable airflow.



**Remote sensor unit**  
The remote sensor provides additional convenience.

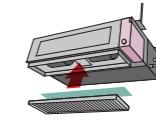
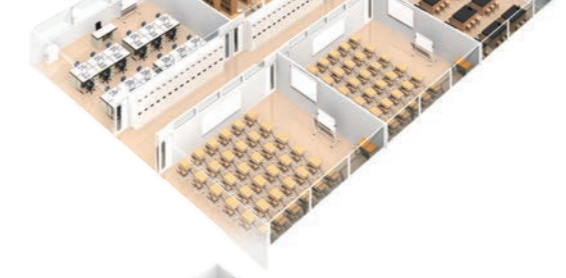

**Silver ion filter**  
The Silver ion filter helps to keep indoor air free from viruses, bacteria and molds.\*



**Long-life filter**  
Captures grit and dust. Long-life design with consideration of running costs.

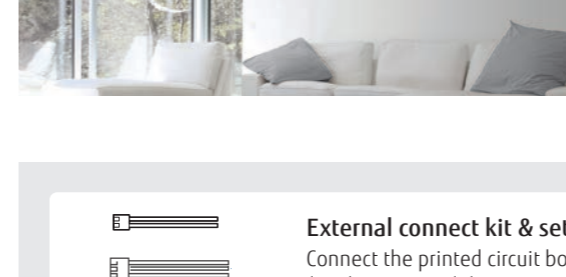

**Flange**  
Flanges are used when connecting a medium static pressure duct type and a ceiling type with air intake and exhaust ducts.

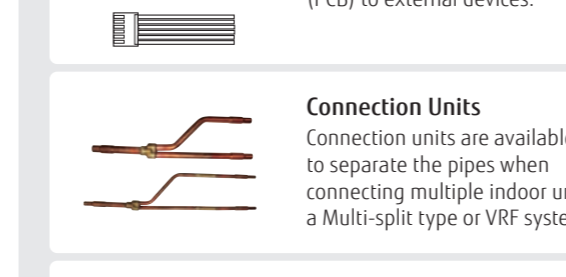

**Drain pump unit**  
Drains water that has accumulated during operation.

## Connection Parts

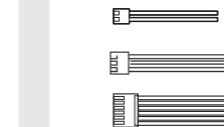

**External connect kit & set**  
Connect the printed circuit board (PCB) to external devices.

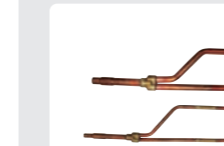

**Connection Units**  
Connection units are available to separate the pipes when connecting multiple indoor units in a Multi-split type or VRF system.



**External power supply unit**  
The External power supply unit protects the increment in the system even if the power supply for some of the indoor units is shut down.



For wall-mounted type

**Communication kit**  
Required for a wall-mounted type when the External connect kit set or a Wired remote controller is connected to the indoor unit.



For wall-mounted type

**External input and output PCB**  
For Wall-mounted, Duct, or Cassette type, these parts are required when the external input and output function is used.



For Duct type and Cassette type



**External input and output PCB box & bracket**  
Box and bracket for installing the External input and output PCB.

\*Not a result of experiments in an actual use environment. Silver ion filter inhibits activity or growth of microorganism, but do not prevent infection.

# Silver Ion Filter

UTR-FA16-5 / UTR-FA13-3 / UTR-FA03-5 / UTD-HFAA / UTD-HFRA / UTD-HFTA / UTD-HFTB / UTD-HFTC / UTD-HFNC / UTD-HFNB / UTD-HFNA / UTD-HFND / UTD-HFKB / UTD-HFKA



For Wall mounted / Floor  
UTR-FA16-5 / UTR-FA13-3  
UTR-FA03-5

For Cassette  
UTD-HFAA / UTD-HFRA

For Duct  
UTD-HFTA / UTD-HFTB  
UTD-HFTC / UTD-HFNC  
UTD-HFNB / UTD-HFNA  
UTD-HFND / UTD-HFKB  
UTD-HFKA

The Silver ion filter helps to keep indoor air free from viruses, bacteria and molds.

(Not a result of experiments in an actual use environment. Silver ion filter inhibits activity or growth of microorganism, but do not prevent infection.)

The silver ion filter inhibits the activities of viruses\*1, bacteria\*2 and molds\*3 trapped on the filter.

(Only effective when the microorganism is trapped on the filter with dust or droplet)

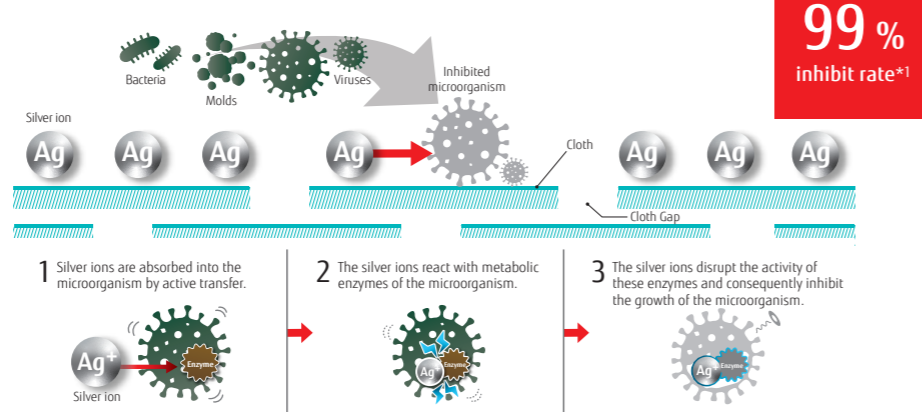

\*1 [Testing organization] Kitasato Research Center for Environmental Science [Test Report] No. 2020\_0408 [Test virus] Escherichia coli phage Qbeta NBRC 20012 (1 type) [Test Method] Based on the antiviral test method for textile products (JIS L 1922) [Test results] Inhibited by at least 99% in 24 hours. Not tested to prevent transmission of SARS-CoV-2.  
\*2 [Testing organization] Kitasato Research Center for Environmental Science [Test Report] No. 2020\_0409 [Test bacteria] Escherichia coli NBRC 3972 (1 type) [Test Method] Based on the determination of antibacterial activity and efficacy of textile products (JIS L 1902) [Test results] The growth of the test bacteria was inhibited by 24 hours testing  
\*3 [Testing organization] Kitasato Research Center for Environmental Science [Test Report] No. 2020\_0410 [Test fungi] Aspergillus Niger NBRC 105649 and other fungi (3 types) [Test Method] Based on the test for fungus resistance (JIS Z 2911) [Test results] The growth of the fungus was inhibited by 28 days testing

The filter is easily removable\* and hand-washable.

(\*Wall mounted and floor models only)



\*4 Hand-washing or vacuuming by 3 months is recommended. Cleaning frequency varies depending on the environment of use.

## Specifications

Model name	For Wall mounted / Floor			for Cassette		
	UTR-FA16-5	UTR-FA13-3	UTR-FA03-5	UTD-HFAA	UTD-HFRA	
Net Dimension (H × W × D)	mm	35 × 210 × 6	50 × 364 × 6	43 × 272 × 6	350 × 125 × 6	550 × 136 × 6
Weight	g	2	2	2	7	23
Quantity		2	2	2	1	1

Model name	for Duct									
	UTD-HFTA	UTD-HFTB	UTD-HFTC	UTD-HFNC	UTD-HFNB	UTD-HFNA	UTD-HFND	UTD-HFKB	UTD-HFKA	
Net Dimension (H × W × D)	mm	290 × 70 × 6	390 × 70 × 6	290 × 70 × 6 390 × 70 × 6	620 × 88 × 6	420 × 88 × 6	620 × 88 × 6	500 × 79 × 6	420 × 125 × 6	620 × 108 × 6
Weight	g	6	8	10	8	10	16	12	16	20
Quantity		2	2	3	1	2	2	2	2	2

# Auto louver grille kit

UTD-GXTA-W / UTD-GXTB-W / UTD-GXTC-W



The optional clean-looking flat Auto louver grille kit blends into any interior and provides a comfortable airflow.



## Flexible Control

- The Auto louver grille of the indoor unit can be operated in conjunction with the remote control of the indoor unit.
- Vertical auto swing**
  - Auto airflow direction and auto swing
  - 4 steps selectable
- Auto-closing louver**
  - The louvers will automatically close when the indoor unit stops operating.

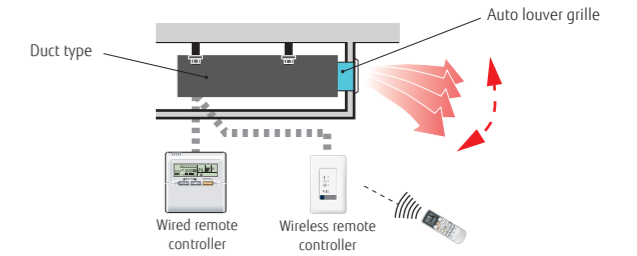

## Dimensions

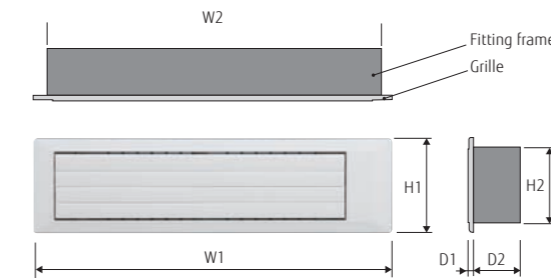

Model name	W1	W2	H1	H2	D1	D2
UTD-GXTA-W	683	645				
UTD-GXTB-W	883	845	180	148	9	84
UTD-GXTC-W	1,083	1,045				

Unit: mm

## Specifications

Model name	UTD-GXTA-W		UTD-GXTB-W		UTD-GXTC-W		
Applicable indoor unit	SPLIT & MULTI-SPLIT ARYG07/09/12/14KSLAP ARXG07/09/12/14KLLAP ARYG07/09LSLAP		ARXG18KSLAP ARXG18KLLAP		ARXD018GLEH ARXD018HLAH ARXK018GLGH		
	VRF ARXD007/009/012/014GLEH ARXK004/007/009/012/014GLGH ARXD04GALH ARXD004/005/007/009/012/014HLAH ARXP009/012/014HLAH		ARXD018GLEH ARXD018HLAH ARXK018GLGH		ARXD024GLEH ARXD024HLAH ARXK024GLGH		
Power supply	Connecting with Control box of indoor unit						
Fixing Auto louver grille	Screwed to Flange or Square duct						
Extension Square duct limit	1.0 m (Max. duct length between indoor unit and Auto louver grille)						
Net Dimensions (H × W × D)	mm	180 × 683 × (84 + 9)		180 × 883 × (84 + 9)		180 × 1,083 × (84 + 9)	
Weight	Net	kg (lbs)		2.0 (4.4)		2.5 (5.6)	3.0 (6.7)
Accessories	Fitting Flame, etc.						
Operating range	Cooling	°C		18 to 32			
		% RH		80 % or less			
Operating range	Heating	°C		16 to 30			

# Pressure sensor kit

UTY-SPWX



## Design flexibility

The height difference between the outdoor unit and the indoor unit is normally 50 m for the V-IV Series, but can be extended to 110 m by installing the Pressure sensor kit. (Can only be connected to the V-IV Series. Also, it can only be connected to outdoor units using outdoor unit software compatible with the product.)

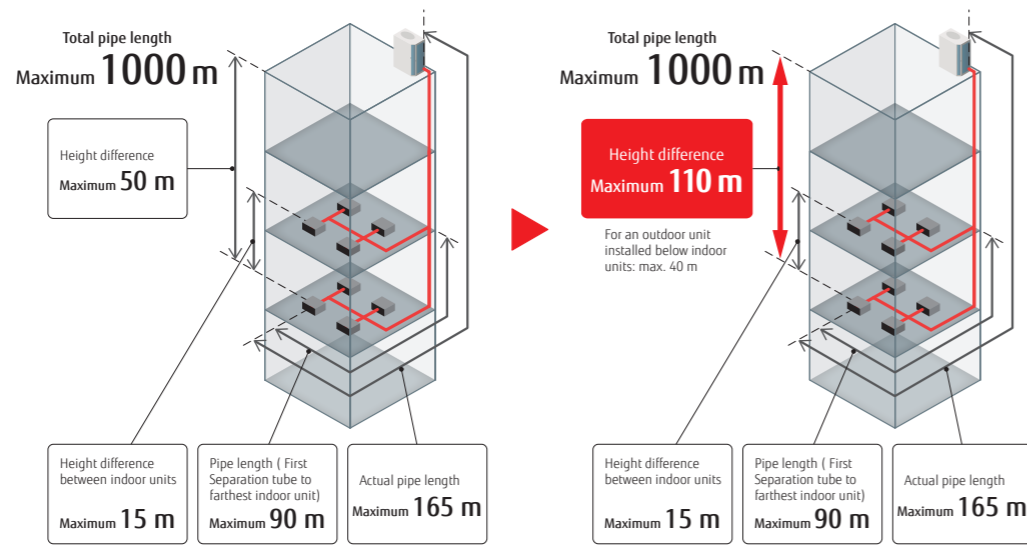

## System overview

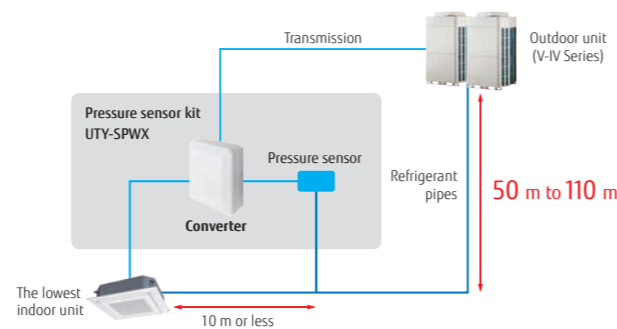

## Pressure sensor kit

Pressure sensor kit (Converter)	Refrigerant pressure sensor	Joint pipe

## Specifications

Model name	UTY-SPWX
Power supply	9 to 16 V DC
Dimensions (H × W × D) (mm)	140 × 117 × 43
Weight (g)	200

# External power supply unit

UTZ-GXXA / UTZ-GXXC



## The External power supply unit protects the increment in the system even if the power supply for some of the indoor units is shut down.

Connects to the External power supply unit to supply power to the indoor unit from the auxiliary power supply. This allows for continuous operation without system errors. Built-in relays reduce installation time and cost. The UTZ-GXXC have a built-in relay, which reduces installation time and cost.

## High reliability

- A: Interruption of the main power supply is detected by the power cut-off detection part.
- B: Supplies power for driving the expansion valve of the indoor unit. (12 V or 5 V DC)
- C: Gives notification of the power supply from the External power supply unit.

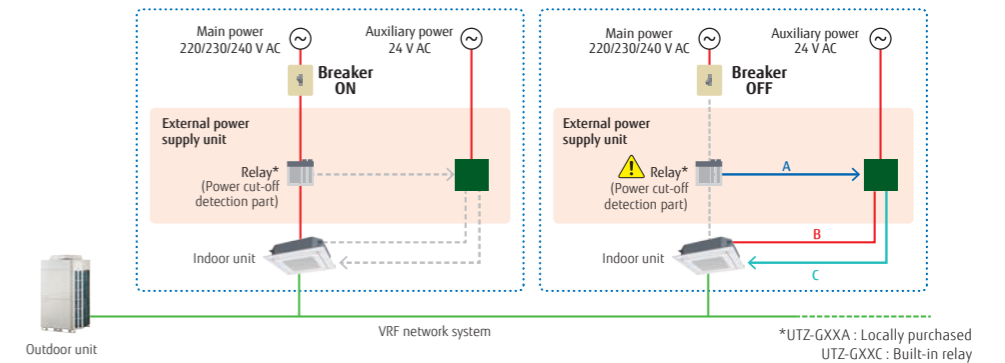

### Note

- When changing the power supply voltage to 24 V AC, use a power transformer with an insulated structure that complies with the regulations\* of the installation region.
- A powered-off indoor unit driven by the External power supply unit is treated in the same way as an operation-off unit in the electricity charge appointment function. If standby power is generated, the result of the electricity charge appointment may not be zero.

\*UL Class II or IEC 61558 Class III, for example.

## Specifications

Model name	UTZ-GXXA	UTZ-GXXC
Power supply	24 V AC 50/60 Hz	
Dimensions (H × W × D) (mm)	97 × 200 × 178	
Weight (g)	800	

# AIR BEAM

## Radiation air outlet unit

\*Production by order  
 Contact us for more details.



## Key component

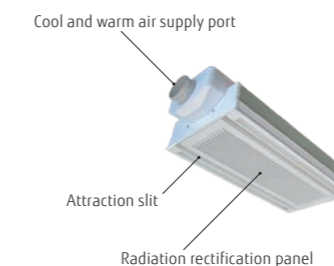

## Cross-section view

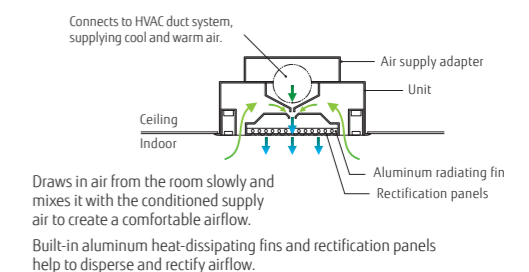

Airflow rate (m <sup>3</sup> /h)	180 (160-215)	270 (240-325)
Grid	600 × 2	600 × 3
AIR BEAM For system ceiling (Integrated type)	KS-180	KS-270



# Gas sensor kit

UTY-SGZY



NEW



## Enhanced disaster safety measures

The system is designed to meet the environmental safety requirements specified in the IEC 603352-40 standard for the use of R32 refrigerant. The environment requiring safety measures is determined by the size of the room in relation to the amount of refrigerant required.

For example, if the system is designed for maximum pipe length and the refrigerant charge is 6 kg, safety measures are required for rooms of 15 m<sup>2</sup> or less.

For Example: Total pipe length 120m

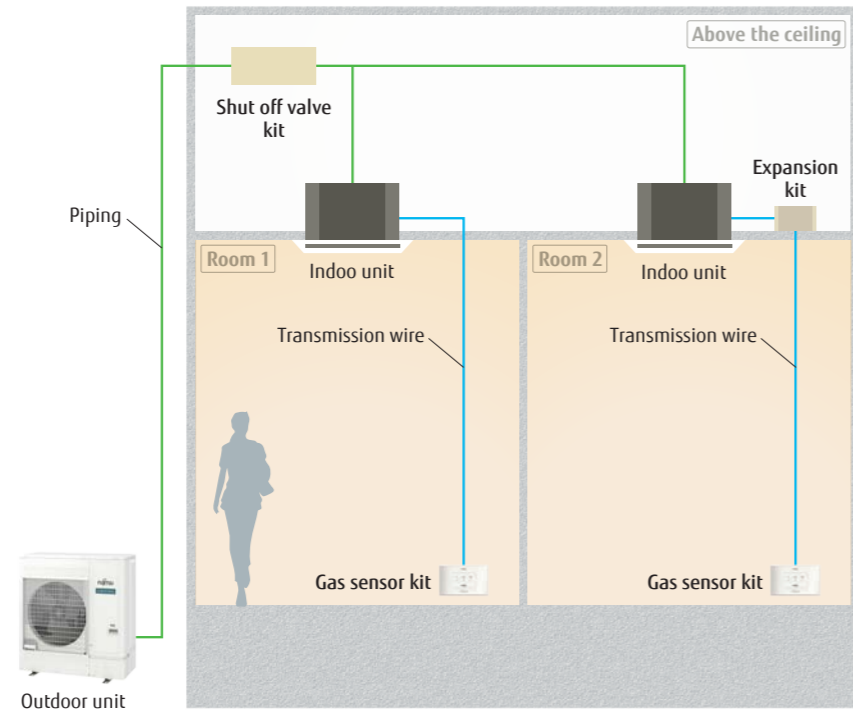

**Shut off valve kit**  
UTP-GX027A, UTP-GX060A

Block the path to prevent refrigerant flow in the event of a refrigerant leakage.

**Gas sensor kit**  
UTY-SGZY\*

Gas Sensor kit Used to ensure standards compliance and safety when R32 VRF products are installed.

\*Connection cable (UTY-XWZXZL) is required.

**Expansion kit**  
UTZ-JXXA

Used to ensure standards compliance and safety when R32 VRF products are installed.

## Conditions requiring safety measures

The graph below will help you determine if a safety design is required when installing R32 VRF products. The amount of refrigerant in a refrigerant system determines the floor area, and if the room to be conditioned by the system is less than that area, a "shut off valve kit" and a "gas sensor kit" must be installed.

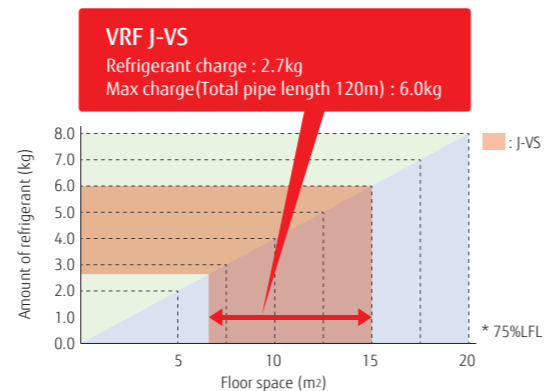

Features: Gas sensor kit

## Refrigerant leak detector connection pattern

1) Corresponds to the case where the classification of air conditioner installation differs from property to property.

Installation position of "Shut off valve kit"

- A** Indoor unit 1~4 in one room
- B** Indoor units 1, 2 and 3, 4, if they are set up in two separate rooms.
- C** Indoor units 1~4 are installed in different rooms.

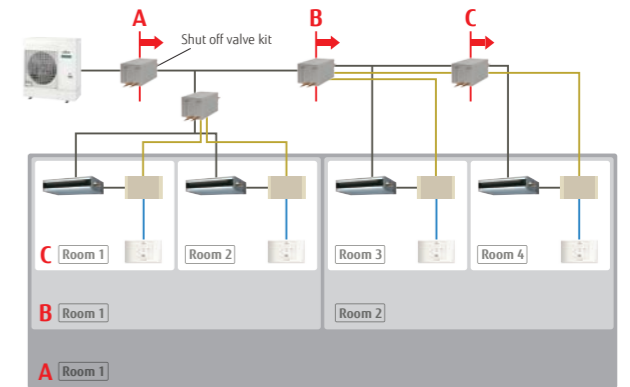

2) Multiple rooms or areas are air conditioned using ducted airflow paths

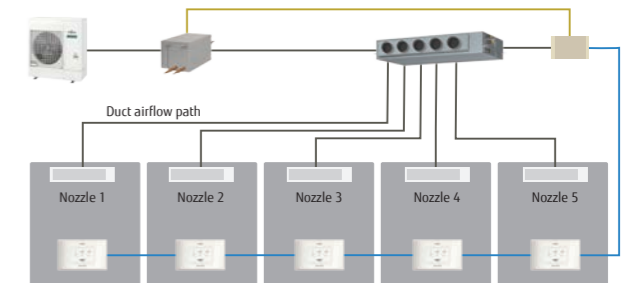

3) When operating multiple indoor units with a remote control group

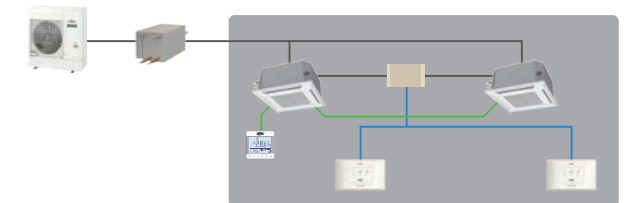

## Specifications

Model name	UTY-SGZY
Dimensions (H × W × D) (mm)	80 × 130 × 35
Weight (g)	500

# Optional parts list for Split/Multi-split



Type	Refrigerant	Indoor unit											Indoor unit										
		Wall-mounted									Cassette	Cassette	Duct					Floor	Ceiling	Multi-split			
		Designer Range			Standard Range			ECO Range			4-way flow Compact	Circular flow	Slim	Medium static pressure (High-Efficiency & Comfort)	Medium static pressure (Compact)	Medium static pressure (Standard)	High static pressure	Big			4-way flow Compact cassette	Mini duct	Slim duct
	ASEH07/09/12/14KGTG, ASYG07/09/12/14KGTG, ASYG07/09/12/14KGTG	ASEG 07/09/12/14, KETF, KETF-B, ASYG 07/09/12/14, KETE, KETE-B	ASEH07/09/12/14KMG, KMG-B, ASYG07/09/12/14KMG, ASYG07/09/12/14KMG	ASEG 18/24KMTG	ASEH 30/36KMTB	ASEH 05/07/09/12 KNCA	ASEG 07/09/12 KPCE	ASEH 07/09/12 KLTA	ASEG 18/24KLCA	AUXG 09/12/14/18/22/24 KVLTA	AUXG 18/22/24/30/36/45/54 KRLB	ARXG 09/12/14/18 KLLAP	ARXH 12/14/18/22/24/30/36/45/54 KMTAP	ARXG 12/14/18/22/24/30/36/45/54 KHTAP	ARXC22KMLB, ARXG 24/30/36/45 KMLA	ARXG45/54KHTB		AGEG 09/12/14 KVCA	ABEG 18/22/24/30/36/45/54 KRTA	AUXG07KVLTA	ARXG 07/09/12/14/18 KSLAP	ARXG07KLLAP	
	R410A															ARYG60LHTA	ARYG72/90LHTA			AUYG07/09LVLTA	ARYG07/09LSLAP	ARYG07/09LLTA	
Human sensor kit												• UTY-SHZXC											
Remote sensor unit	 The remote sensor provides additional convenience.																					• UTY-XSZXZ1	
Cassette grille										• UTG-UFYF-W		• UTG-UKYA-W, UTG-UKYC-W, UTG-UKYA-B										• UTG-UFYF-W (KVLTA), UTG-UFYD-W (LVLTA)	
Auto louver grille kit												• UTD-GXTA-W (09/12/14), UTD-GXTB-W (18)											• UTD-GXTA-W (07/09/12/14), UTD-GXTB-W (18)
Silver ion filter			• UTR-FA16-5		• UTR-FA13-3			• UTR-FA16-5		• UTD-HFAA		• UTD-HFRA	• UTD-HFTA (09/12/14), UTD-HFTB (18)	• UTD-HFNC (12/14/18), UTD-HFNB (22/24), UTD-HFNA (30/36/45/54)	• UTD-HFNC (12/14), UTD-HFNB (18/22/24/30), UTD-HFNA (36/45/54)	• UTD-HFND	• UTD-HFKB (45/54)	• UTD-HFKA	• UTR-FA03-5		• UTD-HFAA	• UTD-HFTA (07/09/12/14), UTD-HFTB (18)	• UTD-HFTA
Long-life filter													• UTD-LFDC (12/14/18), UTD-LFDB (22/24), UTD-LFDA (30/36/45/54)	• UTD-LFNA (36/45/54), UTD-LFNB (18/22/24/30), UTD-LFNC (12/14)	• UTD-LF2SNA	• UTD-LF60KA (45/54)	• UTD-LFKA						
Flange																• UTD-SF045T, UTD-RF204							
Drain pump unit																• UTZ-PX1NBA		• UTZ-PX1NAB			• UTR-DPB24T		
Wide Panel												• UTG-AKXA-W											
Panel spacer												• UTG-BKXA-W											
Fresh air intake kit	 For Compact For Circular flow cassette									• UTZ-VXAA		• UTZ-VXRA										• UTZ-VXAA	
Air outlet shutter plate	 For Compact cassette For Circular flow cassette									• UTR-YDZB		• UTR-YDZK										• UTR-YDZB	
Insulation kit for high humidity										• UTY-KXGC		• UTY-KXRA										• UTY-KXGC	
Half concealed kit	 Used to half conceal a floor type indoor unit in the wall.																					• UTR-STA	
L-type piping kit																						• UTP-FX24A (18/22/24), UTP-FX35A (30/36/45/54)	

# Optional parts list for VRF



Type	Refrigerant	Indoor unit												Indoor unit										V-IV Series	
		Cassette				Slim type		Large type		Duct				Duct			Floor		Ceiling		Wall-mounted				
		One-way flow	3D flow	Compact grid type/ Standard type		Circular flow		Mini (With drain pump)	Low static pressure duct			High Efficiency	Normal	Normal	-	external EEV	Floor/Ceiling	Ceiling	-	external EEV	-	-			
				High Efficiency	High Efficiency	High Efficiency	High Efficiency		High Efficiency	High Efficiency	High Efficiency														
Image	Code	Code	Code	Code	Code	Code	Code	Code	Code	Code	Code	Code	Code	Code	Code	Code	Code	Code	Code	Code	Code				
Human sensor kit																									
Remote sensor unit																									
Cassette grille																									
Auto louver grille kit																									
Silver ion filter																									
Long-life filter																									
Flange																									
Drain Pump Unit																									
Wide Panel																									
Panel spacer																									
Fresh air intake kit*1																									
Air outlet shutter plate:																									
Insulation kit for high humidity																									
Half concealed kit																									
External power supply unit																									
Pressure sensor kit																									
Gas sensor kit																									

# Function list for Split/Multi-split



## External input and output function/External connect kit/communication kit

Type	Refrigerant	Indoor unit												Multi-split						Outdoor unit													
		Wall-mounted						Cassette		Duct				Floor	Ceiling	Wall-mounted	Mini duct	Slim duct	Compact cassette	Single Split		Simultaneous multi-split											
		Designer Range	Standard Range		ECO Range		Compact 4-way flow Range	Circular flow Range	Slim	Medium static pressure (High-Efficiency & Comfort)	Medium static pressure (Compact)	Medium static pressure (Standard)	High static pressure							Big	AUXG 07/KVLA	AUXG 07/KVLA	ADEG 36/45/54 KRTA	ADEG 36/45/54 KRTA									
indoor	R32	ASEH07/09/12/14KGC, ASYG07/09/12/14KGF, ASYG07/09/12/14KGE	ASEG 07/09/12/14 KET, KET-B, ASYG 07/09/12/14 KET, KET-B	ASEH07/09/12/14KMC, ARKG-B, ASYG07/09/12/14KMF, ASYG07/09/12/14KME	ASEG 18/24KMT	ASEH 30/36KMTB	ASEH 07/09/12 KNCA	ASEG 07/09/12 KPCE	ASEH 07/09/12 KLTA	ASEG 18/24KLCA	AUXG 09/12/14/18/22/24 KVLA	AUXG 18/22/24/30/36/45/54KRLB	ARXG 09/12/14/18/22/24/30/36/45/54 KMTAP	ARXG 12/14/18/22/24/30/36/45/54 KHTAP	ARXG 22/24/30/36/45/54KMLB, ARXG 24/30/36/45/54KMLA	ARXG 45/54KH1B	ARYG 60/LHTA	ARYG 72/90/LHTA	AGEG 09/12/14 KVCA	ABEG 18/22/24/30/36/45/54KRLA	ASEG 22KMT	ARXG 07/09/12/14/18 KSLAP	ARXG 07/KLLAP	AUXG 07/KVLA	ADEG 36/45/54 KRTB, ADEG 36/45/54 KRTA	ADEG 36/45/54 KRTA	ADEG 36/45/54 KRTA	ADYG 36/45/54/LAT	ADYG 45/54/LETA, ADYG 72/90/LRLA	ADYG 36/45/LTB	ADYG 36/45/LAT		
R410A																																	
Operation/Stop				● UTY-XCSXZ1+ UTY-XWZXZ5						● PCB Terminal ○ UTY-XCSX+ UTZ-GXDA		● PCB Terminal	● PCB Terminal ○ UTY-XCSX+ UTZ-GXDA	● PCB Terminal ○ UTY-XCSX+ UTZ-GXDA		● PCB Terminal	● PCB Terminal ○ UTY-XCSX+ UTZ-GXEA	● UTD-ECSA	● PCB Terminal ○ UTY-XCSX	● UTY-XWZXZ5	● PCB Terminal ○ UTY-XCSX+ UTZ-GXEA	● UTY-XCSXZ1+ UTY-XWZXZ5	● PCB Terminal	● UTD-ECSA	● PCB Terminal								
Forced stop				● UTY-XCSXZ1+ UTY-XWZXZ5								● PCB Terminal			● PCB Terminal	● UTD-ECSA	● PCB Terminal	● UTY-XWZXZ5	● PCB Terminal	● UTY-XCSXZ1+ UTY-XWZXZ5	● PCB Terminal	● UTD-ECSA	● PCB Terminal										
Forced Thermostat off				● UTY-XCSXZ1+ UTY-XWZXZ5						● UTY-XCSX+ UTZ-GXDA		● UTY-XCSX+ UTZ-GXDA	● UTY-XCSX+ UTZ-GXNA		● UTY-XCSX+ UTZ-GXEA	● UTY-XCSX	● UTY-XWZXZ5	● UTY-XCSX+ UTZ-GXEA	● UTY-XCSXZ1+ UTY-XWZXZ5														
Low noise mode operation																									● UTY-XWZXZ3	● UTY-XWZXZ2	● UTY-XWZXZ3		○ UTY-XWZXZ2				
Outdoor unit operation peak control																									● UTY-XWZXZ3	● UTY-XWZXZ2	● UTY-XWZXZ3		○ UTY-XWZXZ2				
indoor				○ UTY-XCSXZ1+ UTY-XWZXZ5						● UTY-XWZXZG ○ UTY-XCSX+ UTZ-GXDA	● UTY-XWZXZG	● UTY-XWZXZG ○ UTY-XCSX+ UTZ-GXDA	● UTY-XWZXZG ○ UTY-XCSX+ UTZ-GXNA		● UTY-XWZXZG ○ UTY-XCSX+ UTZ-GXEA	○ UTD-ECSA	● UTY-XWZXZG ○ UTY-XCSX	● UTY-XWZXZ5	● UTY-XWZXZG ○ UTY-XCSX+ UTZ-GXEA	● UTY-XCSXZ1+ UTY-XWZXZ5	● UTY-XWZXZG	● UTD-ECSA	● UTY-XWZXZG										
Operation status				○ UTY-XCSXZ1+ UTY-XWZXZ5						● UTY-XWZXZG ○ UTY-XCSX+ UTZ-GXDA	● UTY-XWZXZG	● UTY-XWZXZG ○ UTY-XCSX+ UTZ-GXDA	● UTY-XWZXZG ○ UTY-XCSX+ UTZ-GXNA		● UTY-XWZXZG ○ UTY-XCSX+ UTZ-GXEA		● UTY-XWZXZG ○ UTY-XCSX	● UTY-XWZXZ5	● UTY-XWZXZG ○ UTY-XCSX+ UTZ-GXEA	● UTY-XCSXZ1+ UTY-XWZXZ5	● UTY-XWZXZG	● UTD-ECSA	● UTY-XWZXZG										
Error status				○ UTY-XCSXZ1+ UTY-XWZXZ5						● UTY-XWZXZG ○ UTY-XCSX+ UTZ-GXDA	● UTY-XWZXZG	● UTY-XWZXZG ○ UTY-XCSX+ UTZ-GXDA	● UTY-XWZXZG ○ UTY-XCSX+ UTZ-GXNA		● UTY-XWZXZG ○ UTY-XCSX+ UTZ-GXEA		● UTY-XWZXZG ○ UTY-XCSX	● UTY-XWZXZ5	● UTY-XWZXZG ○ UTY-XCSX+ UTZ-GXEA	● UTY-XCSXZ1+ UTY-XWZXZ5	● UTY-XWZXZG	● UTD-ECSA	● UTY-XWZXZG										
Compressor status																									● UTY-XWZXZ3	● UTY-XWZXZ2	● UTY-XWZXZ3		○ UTY-XWZXZ2				
Indoor unit fan operation status				○ UTY-XCSXZ1+ UTY-XWZXZ5						● UTY-XWZXZG ○ UTY-XCSX+ UTZ-GXDA	● UTY-XWZXZG	● UTY-XWZXZG ○ UTY-XCSX+ UTZ-GXDA	● UTY-XWZXZG ○ UTY-XCSX+ UTZ-GXNA		● UTY-XWZXZG ○ UTY-XCSX+ UTZ-GXEA	○ UTD-ECSA	● UTY-XWZXZG ○ UTY-XCSX	● UTY-XWZXZ5	● UTY-XWZXZG ○ UTY-XCSX+ UTZ-GXEA	● UTY-XCSXZ1+ UTY-XWZXZ5	● UTY-XWZXZG	● UTD-ECSA	● UTY-XWZXZG										
Setpoint attainment status																																	
Auxiliary heater output										● UTY-XWZXZG ○ UTY-XCSX+ UTZ-GXDA	● UTY-XWZXZG	● UTY-XWZXZG ○ UTY-XCSX+ UTZ-GXDA	● UTY-XWZXZG ○ UTY-XCSX+ UTZ-GXNA		● UTY-XWZXZG ○ UTY-XCSX+ UTZ-GXEA	○ UTD-ECSA	● UTY-XWZXZG ○ UTY-XCSX	● UTY-XWZXZ5	● UTY-XWZXZG ○ UTY-XCSX+ UTZ-GXEA	● UTY-XCSXZ1+ UTY-XWZXZ5	● UTY-XWZXZG												

\*1: Included in Fresh air intake kit (UTZ-VXAA or UTZ-VXRA) \*2: Functionality for installation in a server room

●: Dry Contact ○: Apply Voltage

### For SPLIT/MULTI-SPLIT/SIMULTANEOUS MULTI-SPLIT

<p><b>Communication kit</b></p> <p>UTY-TWRXZ3    UTY-TWRXZ2</p>	<p><b>External input and output PCB</b></p> <p>UTY-XCSXZ1 (wire length 280 mm) UTY-XCSXZ2 (wire length 80 mm) for Wall-mounted type UTY-XCSX for Duct and Cassette types</p>	<p><b>External input and output PCB box</b></p> <p>UTZ-GXDA (for Duct) UTZ-GXRA (for Cassette) UTZ-GXEA (for Ceiling)</p>	<p><b>External input and output PCB bracket</b></p> <p>UTZ-GXNA</p>
---	--	---	---

### Communication system

<p><b>External connect kit</b></p>		
<p><b>For indoor unit</b></p> <p>UTY-XWZX    UTY-XWZXZ5    UTY-XWZXZG</p>		
<p><b>For outdoor unit</b></p> <p>UTY-XWZXZ2    UTY-XWZXZ3</p>		

### External control set

<p><b>For indoor unit</b></p> <p>UTD-ECSA</p>
---

# Function list for VRF



## External input and output function/External connect kit

Type	Refrigerant	Indoor unit														Indoor unit				Outdoor unit						controller		Other										
		Cassette		Duct			Floor			Floor/Ceiling				Wall-mounted				J-VS	J-IVL	J-IV	J-IVS	V-IV	VR-IV	Central remote controller	RB unit													
		One-way flow	3D flow	Compact grid type/Standard type	Slim type	Large type	Low static pressure			Low static pressure	Medium static pressure	High static pressure	-		EEV external	-																						
				High Efficiency	Circular flow	Mini (With drain pump)	Slim (With drain pump)	High Efficiency	High Efficiency	Normal	Normal			EEV external																								
	R32			AUXB 004/005/007/ 009/012/014/ 018/HLAH	AUXN 009/012/014 HLAH			ARXD 004/005/007/ 009/012/014/ 018/024 HLAH	ARXP 009/012/014 HLAH									ASYA 004/005/007/ 009/012/014 HCAH	ASYE 004/005/007/ 009/012/014 HCAH						AIY 040/045/054 KCTAH													
	R410A	AUXV 004/007/009/ 012/014/018/ 024GLEH	AUXS 018/024 GLEH	AUXB 004/007/009/ 012/014/018/ 024GLEH		AUXM 018/024/030 GLEH	AUXK 018/024/030/ 034/036/045/ 054GLEH	ARXK 004/007/009/ 012/014/018/ 024GLEH	ARXD 007/009/012/ 014/018/024 GLEH ARXD 04GALH	ARXP 018/030 GLEH	ARXA 024/030/ 036/045 GLEH	ARXC 036/045/060 072/090/096 0TEH	AGYA 004/007/ 009/012/014 GCGH	AGYE 004/007/ 009/012/014 GCEH			ABYA 012/014/018/ 024GTEH	ABYA 030/036/045/ 054GTEH	ASYA 004/007/009/ 012/014 GCGH	ASYE 004/007/009/ 012/014 GCEH	ASYA 18/24GBCH	ASYA 030/034GTEH			AJY 072/090/108/ 126/144/162 LELDH	AJY 040/045/054 LELDH	AJY 040/045/054 LCLDH	AJY 072/090/108/ 126/144/162 LALDH	AJY 072/090/108/ 126/144 GALDH	UTY-DCGYZ3	UTP-RX01AH UTP-RX01BH UTP-RX01CH UTP-RX04BH UTP-RX08AH UTP-RX12AH							
Indoor	Operation/Stop	● UTY-XWZXZD ○ UTY-XWZXZB												● UTY-XWZXZD ○ UTY-XWZXZB																								
	All On/All Off																													● UTY-XWZXZ7 ○ UTY-XWZXZB								
	Group stop																																					
	Forced stop	● UTY-XWZXZD ○ UTY-XWZXZB												● UTY-XWZXZD ○ UTY-XWZXZB																								
	Emergency stop	● UTY-XWZXZD ○ UTY-XWZXZB												● UTY-XWZXZD ○ UTY-XWZXZB																								
	Forced thermostat off	● UTY-XWZXZE ○ UTY-XWZXZ7												● UTY-XWZXZE ○ UTY-XWZXZ7																								
	Low noise mode operation																																					
	Cooling/Heating priority																																			● UTY-XWZXZ6 ○ UTY-XWZXZB		
	Outdoor unit operation peak control																																					
	Power usage information from electricity meter																																					
Indoor	Operation status	● UTY-XWZXZC												● UTY-XWZXZC																						○ UTY-XWZXZA		
	Error status	● UTY-XWZXZC												● UTY-XWZXZC																							○ UTY-XWZXZA	
	Indoor unit fan operation status	● UTY-XWZXZC												● UTY-XWZXZC																								
	Auxiliary heater output																																					
	Base pan heater																																					
Other	Expansion kit	● UTZ-JXXA (HLAH)			● UTZ-JXXA (HLAH)									● UTZ-JXXA (HCAH)																								

\*2: The Touch panel controller has the functions of dry contact and voltage application, but the external connection kit described above is not necessary because the touch panel controller has an external input terminal block. ●: Dry Contact ○: Apply Voltage

**For VRF**

**NEW Expansion kit**  
UTZ-JXXA

**NEW Connection Cable**  
UTY-XWZXZL

**Communication system**

**External connect kit**

**For indoor unit**

- UTY-XWZXZ7
- UTY-XWZXZB
- UTY-XWZXZC

**For outdoor unit**

- UTY-XWZXZ6
- UTY-XWZXZ9
- UTY-XWZXZF

**For RB unit**

- UTY-XWZXZ6
- UTY-XWZXZB

**Central remote controller**

- UTY-XWZXZ7
- UTY-XWZXZ8
- UTY-XWZXZA

**For Touch panel controller**

- UTY-XWZXZA

# Separation tube



## For SPLIT/MULTI-SPLIT/SIMULTANEOUS MULTI-SPLIT

<p>Separation tube</p> <p>UTP-SX236A / UTP-SX254A For 3-phase simultaneous multi-split</p> <p>UTP-SX272A For Simultaneous multi-split Twin/Triple/Double Twin</p>	<p>UTP-SX354A For 3-phase simultaneous multi-split</p> <p>UTP-SX372A For Simultaneous multi-split Twin/Triple/Double Twin</p>
---	---



## for VRF

<p>Separation tube</p> <p>UTP-AX054A</p> <p>Gas pipe</p> <p>Liquid pipe</p>	<p>UTP-AX090A</p> <p>Gas pipe</p> <p>Liquid pipe</p>	<p>UTP-AX180A</p> <p>Gas pipe</p> <p>Liquid pipe</p>	<p>UTP-AX567A</p> <p>Gas pipe</p> <p>Liquid pipe</p>
<p>UTP-BX090A</p> <p>Suction Gas pipe</p> <p>Discharge Gas pipe</p> <p>Liquid pipe</p>	<p>UTP-BX180A</p> <p>Suction Gas pipe</p> <p>Discharge Gas pipe</p> <p>Liquid pipe</p>	<p>UTP-BX567A</p> <p>Suction Gas pipe</p> <p>Discharge Gas pipe</p> <p>Liquid pipe</p>	<p>UTP-LX180A For DX kit</p>

## Header

<p>UTR-H0906L / UTR-H1806L</p> <p>Gas pipe</p> <p>Liquid pipe</p>	<p>UTR-H0908L / UTR-H1808L</p> <p>Gas pipe</p> <p>Liquid pipe</p>	<p>UTP-J0906A / UTP-J1806A</p> <p>Suction gas pipe</p> <p>Discharge gas pipe</p> <p>Liquid pipe</p>	<p>UTP-J0908A / UTP-J1808A</p> <p>Suction gas pipe</p> <p>Discharge gas pipe</p> <p>Liquid pipe</p>
---	---	---	---

## Outdoor unit branch kit

<p>UTP-CX567A</p> <p>Gas Pipe</p> <p>Liquid Pipe</p>	<p>UTP-DX567A</p> <p>Suction Gas Pipe</p> <p>Discharge Gas Pipe</p> <p>Liquid Pipe</p>	<p>UTP-EX060A</p> <p>Gas Pipe</p> <p>Liquid Pipe</p>	<p>UTP-EX096A</p> <p>Gas Pipe</p> <p>Liquid Pipe</p>
--	--	--	--

## Separation tube for RB unit

## for VRF

<p>EV kit</p> <p>Model name <math>\leq</math> 09: UTR-EV09XB Model name <math>\geq</math> 12: UTR-EV14XB for compact wall-mounted type</p>	<p><b>NEW</b> Model name <math>\leq</math> 09: UTR-EV09XC Model name <math>\leq</math> 12: UTR-EV14XC for R32 VRF wall-mounted type</p>	<p><b>NEW</b> UTP-GX027A for R32 VRF indoor unit</p>	<p><b>NEW</b> UTP-GX060A for R32 VRF outdoor unit</p>
--	---	--	---

## RB unit

<p>UTP-RX01AH / UTP-RX01BH / UTP-RX01CH Single type</p>	<p>UTP-RX04BH Multi-split type</p>	<p>UTP-RX08AH Multi-split type</p>	<p>UTP-RX12AH Multi-split type</p>
---	--	--	--

## Specifications

### Separation tube

Model name	UTP-AX054A	UTP-AX090A	UTP-AX180A	UTP-AX567A
Total cooling capacity of indoor unit (kW)	19.6 or less	28.0 or less	28.1 to 56.0	56.1 or more
Model name	UTP-BX090A	UTP-BX180A	UTP-BX567A	
Total cooling capacity of indoor unit (kW)	28.0 or less	28.1 to 56.0	56.1 or more	

### Header

Model name	3-6 Branches	UTR-H0906L	UTR-H1806L
	3-8 Branches	UTR-H0908L	UTR-H1808L
Total cooling capacity of indoor unit (kW)		28.0 or less	28.1 to 56.0
Model name	3-6 Branches	UTP-J0906A	UTP-J1806A
	3-8 Branches	UTP-J0908A	UTP-J1808A
Total cooling capacity of indoor unit (kW)		28.0 or less	28.1 to 56.0

### Outdoor unit branch kit

Model name	UTP-CX567A (for V-IV)	UTP-DX567A (for VR-IV)
Number of outdoor units	2 outdoor units	1
	3 outdoor units	2

### EV kit

Model name	UTR-EV09XB	UTR-EV14XB	UTR-EV09XC	UTR-EV14XC
Application model	ASYE004GCEH ASYE007GCEH ASYE009GCEH	AGYE004GCEH AGYE007GCEH AGYE009GCEH	ASYE012GCEH AGYE014GCEH	ASYE004HCAH ASYE005HCAH ASYE007HCAH ASYE009HCAH

### RB unit

Type	Single type						Multi-split type		
Model name	UTP-RX01AH	UTP-RX01BH	UTP-RX01CH	UTP-RX04BH	UTP-RX08AH	UTP-RX12AH			
Power source	230/1/50								
Input power	W								
Number of branches	1	1	1	4	8	12			
Maximum capacity of connectable indoor units (Q)	kW								
Maximum capacity of connectable indoor units per branch (Q)	kW								
Maximum Connectable Indoor Units per Branch	3	8	8	8	7	7			
Dimensions (H × W × D)	mm								
	198 × 298 × 268			260 × 658 × 428		298 × 660 × 618		298 × 990 × 618	

\*1: When two RB units are connected in series (8 branches in total), the maximum capacity of the connectable indoor units is up to 56.0 kW.

### Shut off valve kit

Model name	UTP-GX027A		UTP-GX060A
Power source	230/1/50		230/1/50
Input power	W		24
Number of branches	1		1
Maximum number of connectable Expansion kit	kW		4
Maximum capacity of connectable indoor units (Q)	kW		Q $\leq$ 8.0
Maximum capacity of Connectable Indoor Units per Branch (Q)	kW		Q $\leq$ 8.0
Dimensions (H × W × D)	mm		250 × 540 × 267